

6/8/11
Saturday

Marks :- 27 to 30.

CASTING

ref: principles of metal casting by Koffa and Ruzzenbat.
work shop technology by Hajra Choudari.

Casting is a process in which the liquid molten metal is poured into the casting cavity, allow it to solidify and after solidification, the casting can be taken out by breaking the mould.

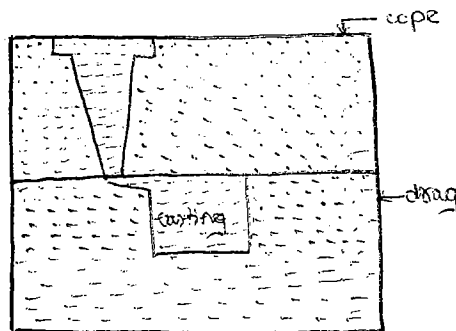

we pour the liquid molten metal in the casting cavity.

Steps

- ① Pattern making
- ② Mould and core making
- ③ Pouring and solidification
- ④ Fettling
- ⑤ Inspection

Pattern making

Replica of the casting to be produced is the pattern.

Replica means that shape of the pattern remain same as the shape of the casting to be produced but the dimensions of the pattern is different from the casting.

$$\text{pattern size} = \text{Casting size} \pm \text{Allowances}$$

Allowances :-

5 diff types of allowances

- ① Shrinkage allowance
 - ② machining allowance
 - ③ Draft allowance
 - ④ Shake allowance
 - ⑤ Distortion allowance
- } These two have greater significance in change in size.

① Shrinkage allowance :-

The metals are poured at the pouring temperature

$$\text{Pouring temp} = \text{Melting Point} + 150-200^{\circ}\text{C}$$

→ degree of superheat

* Always the pouring temperature must be greater than M.P

To avoid the solidification of the molten metal in the passages
[It make use of sensible heat than the latent heat ; thus no phase change occurs]

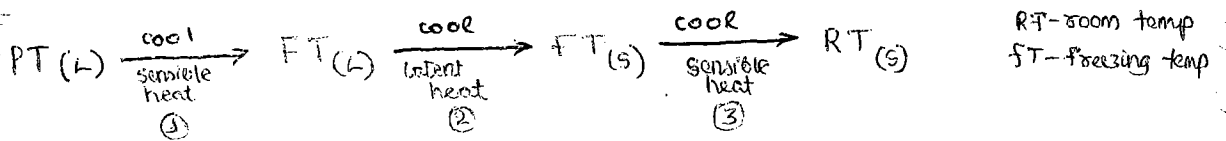

3 stages is volved in cooling.

* In all the 3 stages of cooling ; the shrinkage of material will be taking place.
whatever shrinkage taking place in the 1st and 2nd stage is named as liquid shrinkage and whatever shrinkage taking place in 3rd stage is named as solid shrinkage.

The liquid shrinkages are compensated by the size and solid shrinkage by providing shrinkage allowance on the pattern.

shrinkage allowance is the allowance provided in pattern for compensating solid shrinkage taking place during casting of the material from freezing temperature as a solid to the room temperature.

aluminium has the highest liquid shrinkage [6%]

Because the liquids are measured as a form of volume, liquid shrinkages can be specified as a % by volume.

Because the solids are measurable as dimensions, the solid shrinkage will always be specified as a % over dimension.

When a material is heated it expands by

$$\begin{aligned} \Delta L &= L \alpha \Delta T \\ &= L \alpha (T_F - T_R) \end{aligned}$$

L - dimension
α - Coeff of thermal expansion
ΔT - change in temp.
T_F - final temp
T_R - room temp

How much will shrink. So this is the shrinkage allowance

$$\text{shrinkage allowance} = L \alpha (T_F - T_R)$$

It mainly depends of α

As per speaking S.A should be calculated by this formula but due to unavailability of all

Bronze - is having highest solid shrinkage and thus highest shrinkage allowance $[\alpha = 23 \mu\text{m}/\text{m}^\circ\text{C}]$

Admiralty metal - It is having slightly higher $\alpha = 23.5 \mu\text{m}/\text{m}^\circ\text{C}$

Invar, Platinum-iridium alloy - $\alpha =$ 'almost 0'

Invar - $\alpha = 0.0000096$

For casting of these 2 metals NO shrinkage allowance is provided

Grey cast Iron, Ice - $[\alpha = -\text{ve}]$

on cooling it expands and contracts on heating.

Taking all shrinkage together is the total shrinkage.

Steel - liquid and solid shrinkage taken together would be highest in steel.

* largest size needed - Aluminium

* largest cool volume - bronze

* Casting = $200 \times 100 \times 50$] Grey cast iron.
SA = 1%

$$? \frac{\text{Vol of Part}}{\text{Vol of casting}} = \frac{(0.99)^3 [200 \times 100 \times 50]}{[200 \times 100 \times 50]} = \frac{(0.99)^3}{1} = 0.97$$

Since -ve allowance volume should be reduced.
99%
 $200 \times \frac{99}{100}$
 $99 \times [2 \times 1 \times \frac{1}{2}]$
 $\frac{99}{2}$

② Machining allowance

The excess material provided on the pattern which will be removed by machining of the casting after the casting process is completed.

It's be provided due to

① As it is the casted components, will have poor surface finish, most of the engineering components require good or excellent surface finish which is possible by machining. \therefore for machining the component excess materials should be provided.

② To accommodate variations in shrinkages taking place due to the variations of room temperature.

$$SA = L \alpha (T_f - T_r)$$

Machining allowance is provided on x mm/side.

eg: Cylinder $D = 20 \text{ cm}$ $SA = 2 \text{ in } 100 = \frac{2}{100}$ or 2×100
 $L = 300 \text{ mm}$ $\therefore MA = 2 \text{ mm/side}$

with the dimensions of pattern provided by SA & MA

$$D = 200 + \frac{2}{100} \times 200 = 204$$

$$L = 500 + \frac{2}{100} \times 500 = 510$$

dimensions with SA + MA

$$D = 204 + 2 + 2 = 208$$

$$L = 510 + 2 + 2 = 514$$

OR

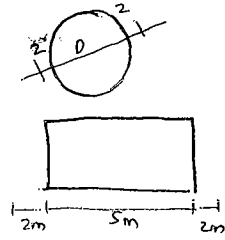

better:- dimension of pattern size with MA

$$D = 200 + 2 + 2 = 204$$

$$L = 500 + 2 + 2 = 504$$

PS with MA + SA

$$D = 204 + \frac{2}{100} \times 204 = 208.08$$

$$L = 504 + \frac{2}{100} \times 504 = 514.08$$

③ Draft allowance

Making the vertical surfaces of the pattern into inclined surfaces for easy removal of the pattern from the mould.

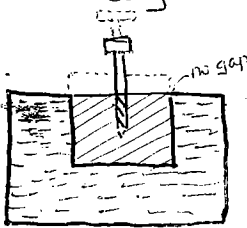

* always the removal of pattern should be with human hand.
No machines should be engaged.

So if a small stake to our hand - disruption occurs

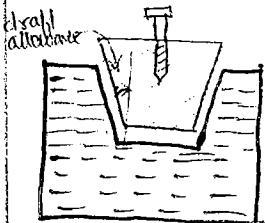

without providing draft allowance - until the last point of the pattern comes out from the mould, there is a contact b/w the pattern and the mould and any shaking or vibration takes place to the hand may causes to damage the mould walls.

with the provision of draft allowance, as soon as a small amount of pattern is lifted from the mould, immediately the clearance or gap is existing b/w the pattern and the mould. \therefore the pattern can be removed easily without any damages to the mould walls.

for external slant surfaces the draft allowance is $1-3^\circ$

for internal surfaces the draft allowance = $5-8^\circ$

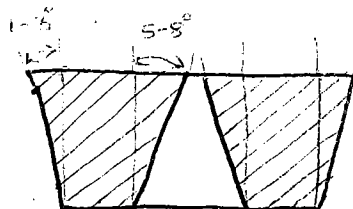

NOTE :- In casting process; if pattern is made by using the materials like wax, mercury, and polystyrene as a pattern; ~~then~~ ^{then} ~~no~~ ^{no} draft allowance is to be provided.

mercury at room temp \Rightarrow liquid / melting point of Hg is -39°C .

Thus mercury when cooled to -70 to -80°C ; perfect solid Hg is obtained. Then mould is made and when kept in room temp. it changes to liquid. So easily removed.

In case of wax when the molten metal is poured; it's removed in liquid state.

Polystyrene not polystyrene (thermosetting plastic) - it can't be converted to liquid

\rightarrow (thermo plastic) - it's been used.

without removing ~~with~~ pattern metal is removed.

M.P of polystyrene - $170-200^\circ\text{C}$ and vapourisation temp is 250

The pouring temp would be above it and with in no time the polystyrene is vapourized and escaped by the porosity proper of moulding sand. Also it's escaped through risers.

application \rightarrow Very large sized casting like machine tool beds.

disadvantages \rightarrow Not reusable

* large sized pattern could not be removed by human hands \Rightarrow so here no need of removal of pattern.

④ shake allowance :-

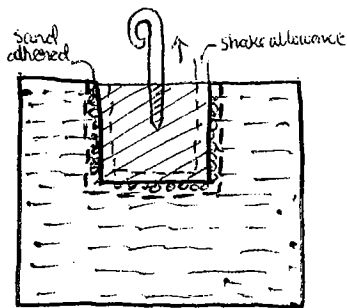

During removal of the pattern from the mould, whatever the moulding sand which has adhered to the pattern also gets removed and it damages the mould walls.

To avoid this, before removal of the pattern from the mould, the pattern will be ^{shaken} so that the adhered moulding sand will be separated and no damages would take place to the mould.

But during shaking of the pattern the size of the cavity produced will become greater than the size of the pattern; which increases the size of the casting.

To maintain the size of the casting as required, originally the pattern size has to be reduced by an amount equal to shake allowance.

The amount of the shake allowance depends on the mold making person. If the pattern is made of wax or Hg or polystyrene ~~as the~~, no shake allowance is ^{provided}.

⑤ Distortion allowance

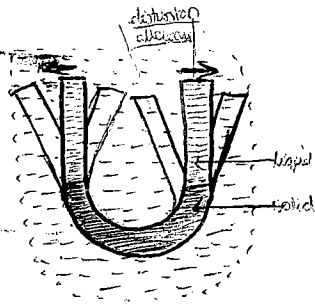

It's not required on all the castings but it's required to provide only during the casting of U or V shaped castings to be produced.

During casting of U or V shaped castings, because of the differential shrinkage; the vertical legs of U may get bent outwards and produces inclined legs of U.

To get vertical legs of U in the original pattern; the legs would be bent inwards so that during casting these legs would be bent outward and produces vertical legs of U.

The amount of bending legs inward is called distortion allowance.

The amount of distortion allowance depends on $\frac{L}{t}$ ratio where L - length of the leg and t - thickness of leg.

Pattern materials

Properties

① Low or minimum moisture absorption.

If moisture absorption takes place - pattern increases size \rightarrow cavity increases \rightarrow casting size \rightarrow ^{increases}

② Low density - for easy handling (placing and removal)

③ Good or excellent surface finish

④ Easier in fabrication.

⑤ Cheap

Materials

1. Wood :-

light weight, low density, all the properties req. for pattern is present (OA - 8g/cc)

except moisture absorption.

whichever wood having low moisture absorption; the corresponding wood can be taken as pattern materials.

eg:- Teak wood, mahogany.

2. Metal :-

would have a problem of difficulty in manufacturing and density would be high.

Out of all metals lowest ρ is possessed by Al (2.7g/cc) but it has density almost 5 to 8 times higher than the density of ~~for~~ wood.

metal patterns are to be produced again by wood pattern by casting process. [double shrinkage allowance must be in the wood pattern ($\text{wood} \xrightarrow{SA} \text{metal pat} \xrightarrow{SA} \text{casting}$)

eg:- Al, white metal
 \downarrow \downarrow
(2.7 g/cc) (3.2 g/cc)

3. Plastic pattern :-

plastics are posing all good properties which are required for pattern material

∴ plastics are the most commonly used pattern materials in the casting industry today

eg:- epoxy resin, PVC, cellulose, Nylon, polystyrene etc.

4. Wax :-

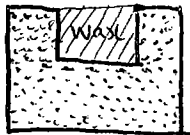

heat to 80-100°C

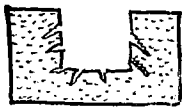

because of very high softness, wax could be used as a pattern material for producing complex shapes of the patterns very easily.

removal of the wax pattern is also easier in the form of liquid wax. Good or excellent surface finish is possible \Rightarrow no machining is required after the casting process.

Because of very high softness; when the pattern is transported from one place to another place; the pattern may get distorted. To avoid this max. size of pattern used is 5 kg only.

When wax is used with green sand mould; rapid rat tailed defects are produced in the casting.

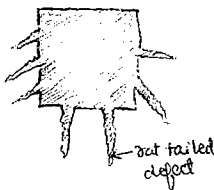

Due to vapourisation of water content in green sand - cracks are developed when casting this would result in rat tail shaped projections.

used for producing gold and silver ornaments, turbine blades, wave gauges for radar systems etc.

5. Frozen mercury

cooling Hg to -70 to -80°C.

Since density of Hg is very very high - its been used for producing very small sized casting which requires excellent surface finish without machining itself.

not used in commercial application. Only in special applications like in aerospace, its used.

MOULD MAKING

Moulding sands are used to manufacture the mold.

basic constituents

① Silica sand particles \Rightarrow [75 to 80%]

Used for producing required strength of the moulding sand.

② clay \Rightarrow [15 to 20%]

To produce the bond b/w the sand particles.

③ Water / Sodium silicate \Rightarrow [6 to 8%]

To initiate the formation of bond b/w the sand particle & clay.

Silica sand + clay + water \longrightarrow Green sand

Silica sand + clay + Sod. Silicate \longrightarrow Dry sand

Any sand with **50%** clay \longrightarrow loam sand (producing very long casts)

Additives

Added to improve properties of moulding sand

① Wood powder or saw dust

To increase porosity property and collapsibility of the moulding sand.

② Loat powder

To increase the refractoriness property of moulding sand.

③ starch / Dextrin

To increase the resistance to deformation or strength of the mold ^{scale}.

* upto a maximum of 2% each additive could be added

Properties posed by moulding sand

① Porosity

ability of escaping air or gases through the moulding sand.

determining porosity

using permeability test. [American Foundry Society] or

* permeability is not a property of moulding sand but it's only a mere test to measure the porosity property of sand.

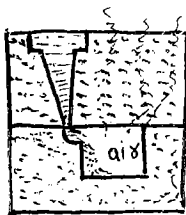

if not expanded
air get trapped &
compressed to form
defects

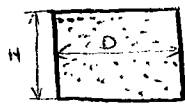

sand specimen
 $D = H = 5.08 \text{ cm}$

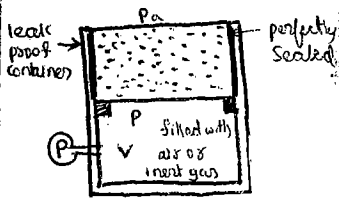

$V = \text{vol. of container before the sand specimen}$

$V = 200 \text{ cc}$

$P > P_a$

$T = \text{time taken to reduce volume } V \text{ from pressure } P \text{ to } P_a$

$$\text{Permeability No} = \frac{VH}{PAT}$$

$P = \text{gauge pressure in } \text{kg/cm}^2$

$A \rightarrow \text{known sectional area}$

$T = \text{time}$

$V \rightarrow \text{Volume} = 200 \text{ cc}$

$H = D = 5.08 \text{ cm}$

$P = 10 \text{ kg/cm}^2$
 standard

$$\text{Perm No} = \frac{50.128}{T}$$

→ prepare the sand specimen of dia D and height H .

→ then place this specimen in leak proof container whose sides are perfectly sealed to avoid the permeability of sand through sides.

→ then volume of lower side of the container is $V = 200 \text{ cc}$

→ a pressure $P > P_a$ is supplied by pumping air. the lower side is connected with a pressure gauge.

→ calculate the time taken for the pressure drop of P to P_a in minutes.

How to increase porosity

- ① Increasing sand particle size
- ② Reducing clay content
- ③ Adding wood powder
- ④ Reducing ramming force \Rightarrow with reduction of ramming force strength of the \downarrow decrease
- ⑤ Providing vent holes (venting)

② STRENGTH

3 types - Tensile strength, compressive strength, shear strength

All these strengths could be measured using UTM

③ Cohesion - the ability to form bond b/w particles of same material is called cohesion. This can also be indicated by using shear strength.

determination of shear strength.

Inter laminar shear strength test (ILSS)

two layers of same material as shown in fig is made

eccentric loading is applied.



④ Adhesion

the ability of formation of bond of sand materials with other material

two layers of different materials are made as shown.

then bonding strength is calculated or determined.

It can't be called as ILSS. It's not inter laminar.



⑤ Refractiveness

the ability for withstand higher temperature without losing its strength and hardness.

Determination

Done by using UTM with temperature control chamber.

If the load can be applied on the specimen upto a required length of the specimen

then slowly increase the temp of the chamber slowly.

for some temp. the sand specimen will fail

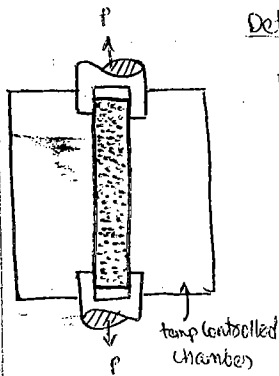

⑥ Collapsability

Ability of breaking the mould with little amount of the force.

measured by using vibratory mesh

Sand specimen kept in vibratory mesh and apply vibration.

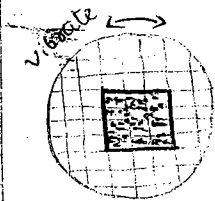

⑦ Flowability

the ability of moulding sand to flow to each & every corner of the mould.

Flow characteristics of liquid and gases (i.e. fluids) is defined by fluidity.

But flow characteristics of solid is defined by flowability

measured by using orifices.

Mold making

① Hand molding :-

whatever the force required for ramming of the moulding sand; if obtained by human hand - it is called as hand moulding.

cheapest method → no equipment is required and no damages will take place to pattern because human beings know that where the projections and extensions are present. for such places he apply lesser amount of force.

Limitation :-

the strength & hardness of the mould obtained is non uniform

Production rate is low.

② machine molding :-

whatever the force required for ramming of the moulding sand; if obtained by using a machine.

(a) Jolting operation

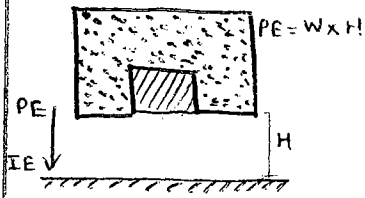

A sand filled mould is raised to certain amount of height so that it is possessing potential energy, when it is allowed to fall freely on the ground, the potential energy is converted into impact energy and impact load which is acting on the ground.

The equal and opposite reaction force produced by the ground mould is acting on the mould for compressing the moulding sand.

Bcz of force applied by the ground is not able to transfer up to the top of the mould, the bottom of the mould is attaining higher strength and hardness but the top of the mould is almost like a loose sand.

(b) Squeezing operation

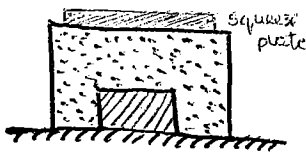

The force is applied by using the press on to the plate its would be transferred on the moulding sand and compressing the sand.

Bcz of the force applied by the plate not transferring up to the bottom, the top of the mold attain higher strength and hardness but bottom will be possessing lower strength.

(c) Combination By combining jolting & squeezing operation, higher strength could be obtained on top and bottom.

If the ht of mold $< 200 \text{ mm}$ - it's possible to get uniform strength and hardness through out the mould but if the ht of mold $> 200 \text{ mm}$ - the central part of the mould attain the lowest strength.

(d) Sand slinging To get the uniform strength throughout with whatever be the height of the mould; the best method of machine moulding is sand slinging.

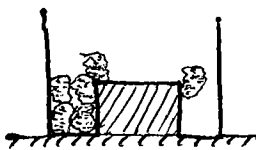

Small small quantities of moulding sand will be thrown into mould with certain amount of force using machine \Rightarrow so that localized ramming of moulding sand will take place & gives uniform strength through out the mold.

Limitation:

Cost of equipment is high and cannot be used for molding pattern having extensions and projections.

Core making process :-

cores are used for producing hollow castings.

Properties

- ① Non metallic materials should be used.
(for easy removal and for no bond formation)
- ② Free from moisture
(to avoid defects by evaporation of this moisture)
- ③ Higher strength
(to withstand self wt and wt of molten metal)
- ④ High collapsibility
(for easy removal of core after casting)

* ③ and ④ are contradicting properties

eg:- Dry sand with CO₂ moulding

Dry sand taken in a core box and then thru a small pipe high pressure CO₂ is passed for 1-2 minutes.

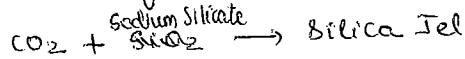

Immediately take the pipe and allow it to dry, with in few minutes (1-2 min) it's dried and open the core box and take out the core (high strength)

Adv:-

whatever the high strength obtained is short lived. After 2-3 hrs duration (silica gel formation)

the strength of the core start deteriorating and after 5 hrs, the strength of core is almost '0'. it is found as loose sand. (collapsible)

DONT MAKE CORES AND KEEP IN STORE → foundry saying.

Core print :-

are used for locating, supporting, positioning.

Core prints are produced by providing extension on the pattern

When extensions are provided on the pattern, the removal of pattern from the mould becomes difficult ∴ the pattern will be split into 2 pieces

one piece of the pattern will be kept in the cop and another piece on the drag and the mould is made.

So core-print comes in the junction of cop and drag

this make easy positioning and set of cores

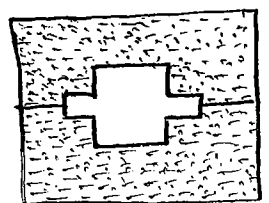
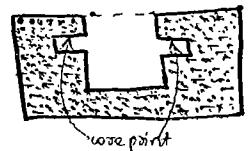
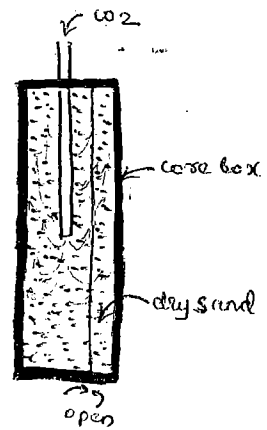
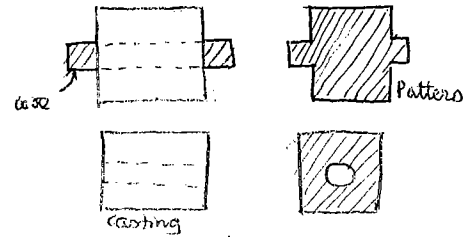
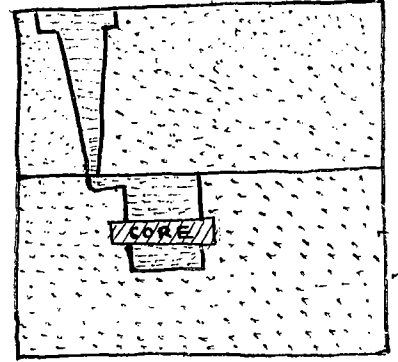

Note "No two materials are having same density". Here solid core is immersed liquid molten metal. In general the $\rho_{\text{core}} < \rho_{\text{molten metal}}$. Thus an upward buoyant force would be acted upon the core.

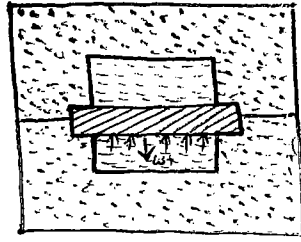

Horizontal core

Net buoyant force = wt of liquid displaced - wt of core

$$= V \rho g - v d g$$

$$\boxed{BF = v g (\rho - d)}$$

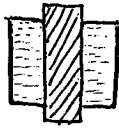

vertical core
(No buoyant force)

but

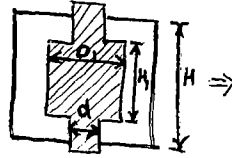

BF = wt of liq displaced by projected volume - wt of core

$$= \left[\frac{\pi}{4} (D^2 - d^2) H \right] \rho g - \left[\frac{\pi}{4} d^2 H + \frac{\pi}{4} (D^2 - d^2) H \right] d g$$

$$\boxed{\text{load supplied by core print} = 350 A \text{ Newtons}}$$

where A = surface area of crown print in m^2 .

$$\boxed{\text{unsupported load} = \text{Net B.F} - 350 A}$$

$\leq 0 \Rightarrow$ no additional supports required

$> 0 \Rightarrow$ additional supports required

whenever the unsupported load is > 0 ; the additional supports required can be provided by using chaplets

Chaplets are used by using same materials as that of the casting. They become an integral part of the casting.

Thus before placing chaplets - it should be thoroughly cleaned to avoid weak joint formation b/w the chaplets and the solidified metal, and the

chaplet size

For every 1N of unsupported load 29 mm^2 c/s area chaplets should be used

For 10N $\rightarrow 290 \text{ mm}^2$

Though chaplet is used as an additional support for core; the chaplets also provide the additional functionality as a directional solidification.

Note

Pads :-

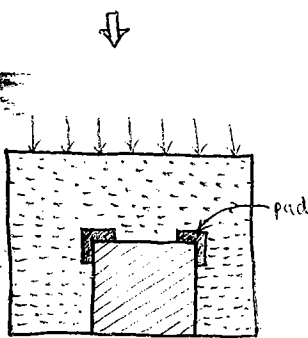
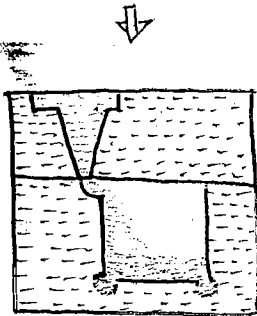
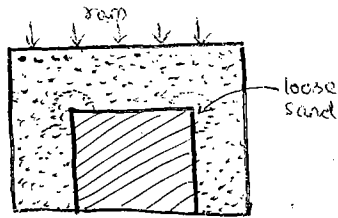

During the casting of sharp edged castings, the patterns used will also have sharp edges.

When making mold - this sharp edged patterns, the sand particles present in the corners will get slipped and produces loose sand particles.

During pouring of molten metal to the casting cavity this loose sand particles will get eroded from the mold and entering into the cavity producing sand inclusions in the casting.

To avoid this during moulding itself L shaped metal or non-metallic pads will be provided so that they will be retaining the mold when pouring of the molten metal and avoids direct contact b/w the loose sand particles and the molten metal.

hence eliminate the sand erosion and sand inclusion defect.

Hence L-shaped pieces are called pads (padding)

Since thermal conductivity of pads is greater than the moulding sand the pads also provides directional solidification.

Chills :-

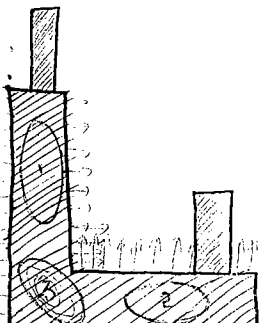
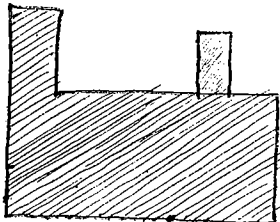
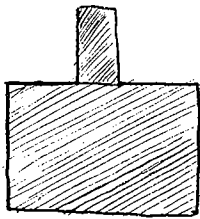

Riser is located based on :-

- ① During uniform crosssectioned casting the riser is provided on the top most point of casting cavity.
- ② If the casting is of non-uniform crosssection, the riser is provided near to the thickest portion than the thinnest portion.

In L shaped uniform casting two risers are shown provided as shown in the figure.

Here due to the presence of risers zone 1 and zone 2 are solidified early and then only zone 3 cools. This is because as the quantity of molten metal is large in zone 3, so more heat is required also in the corner region, the heat transfer is taking place in 2 directions. \therefore the temperature of mold becomes high and temp diff is reducing. hence reduced heat transfer.

Due to this whatever shrinkages are occurring due to the solidification of zone 3 cannot be compensated by both the risers. Hence produces defect known as shrinkage cavity.

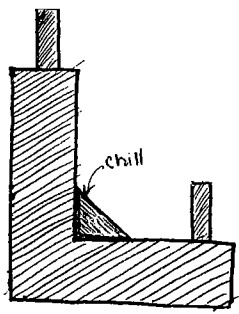

to reduce this defect we should increase the heat transfer rate and some molten metal to be solidified before (forms) (corner portion)

- $Q \propto \Delta T$ X temp can't be reduced
- $\propto A$ X unable to change the area of cavity
- \propto X
- $\propto k$ ✓ by providing high thermal conductive metallic pieces on the corner of mould.

eg: - bullet cover making

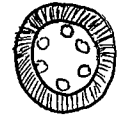

in bullet cover, high compressive strength are provided to inner walls by providing pipes thru which coolants are supplied in the case.

The provision of metallic piece try to transfer the heat in a specified direction so that the solidification will take place according to required methodology known as directional solidification.

The metallic piece provided in the mould is called chills. So they are used for directional solidification. They are materials of higher thermal conductivity. It also have ~~the~~ melting point temp. higher than the casting metal.

The chill is getting adherent to the casting in the casting process and it's unwanted material. \therefore it have to be removed by machining afterwards.

POURING

The molten metal is always poured into the casting cavity by using a system called the gating system. Gating system basically constitutes 4

- ① Pouring basin
- ② Sprue
- ③ Runner
- ④ Ingate

characteristics of proper gating system (Ideal or good)

* The gating system should be designed so that the time taken for filling of molten metal to the cavity must be as minimum as possible. This is to ensure that no-part of the casting cavity should start to solidify before complete filling of the casting cavity.

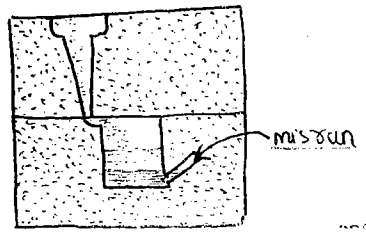

$$\text{Pouring Time} = \frac{\text{Vol of cavity}}{\text{flow rate}}$$

$$P.T = \frac{V}{\text{Area} \times \text{Velocity}}$$

$\swarrow A_{min} \times Vel$
 $\searrow A_{max} \times Vel$

area & velocity can't be changed. So only by increasing velocity

* The velocity of molten metal in the gating system should be as high as possible within the limits of laminar flow.

* As far as possible, the gating system should separate the impurities present in the molten metal.

* It should eliminate the sand erosion.

* It should avoid the aspiration effect.

* The flow of molten metal in the gating system should be always full and the partial flow should not be allowed.

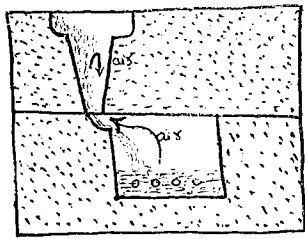

When the cavity is been filled by molten metal; the air get compressed. Instead of moving out through the moulding sand it goes out through the gating system and thus form bubbles entrapped in the molten metal poured.

Pouring basin

It's acting as a reservoir for supplying the molten metal to the

casting cavity (basic function)

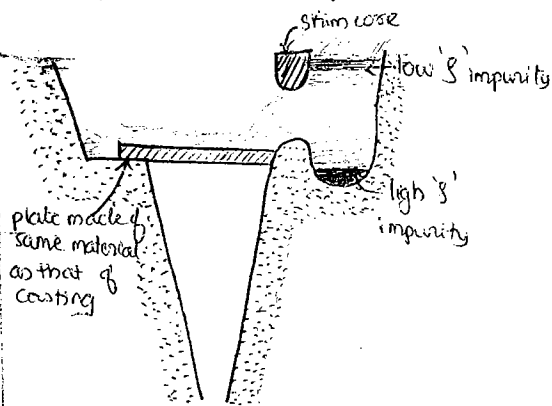

Separates the impurities present in the molten metal.

The thin layer provided at the end of pouring basin collects the molten metal over it - so that the excess heat available in the molten metal will be absorbed by the plate and get melted (total plate) at a time.

So that the molten metal produced by the plate and the molten metal collected over the plate are flowing through the gating system, simultaneously.

It ensures the full flow of molten metal thru the gating system.

The dimensions (shape or size) ; will not affect the performance of the gating system of pouring basin.

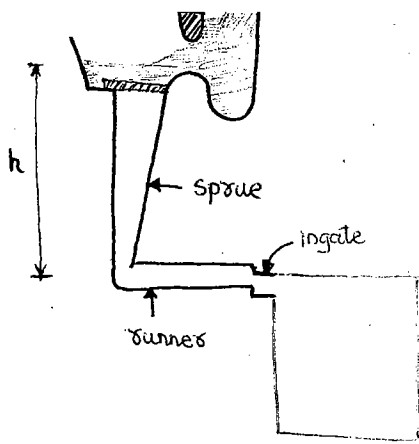

Sprue

It's a connecting passage b/w the pouring basin and the runner. It's always vertical with straight tapered circular cross section.

The tapered shape of sprue eliminates the aspiration effect.

The height of the sprue is responsible for producing the velocity of molten metal in the gating system. \therefore the height of the sprue is selected such that the velocity of molten metal at the gating system must be as high as possible within the limits of laminar flow. $v = \sqrt{2gh}$.

let $A_s = \text{C.S.A of sprue (bottom)}$

Runner

Connecting passage b/w the bottom of the sprue and the ingate.

It's always horizontal with uniform trapezoidal cross section.

Out of all the shapes the trapezoidal cross section is the one which is having highest coefficient of discharge. So trapezoidal cross section is used. $C_{d1} = C_d C_c$

When ever the flow is taking place in a passage - bcz of the presence of the datum head, the value of coefficient of discharge remains constant irrespective of the cross section of the passage. \therefore if circular cross section is selected for the sprue - it's easy in manufacture.

$A_r = \text{C.S.A of the runner.}$

It's necessary to divert the flow from sprue to horizontal to reduce the sand erosion.

INGATE

It's the last point of casting cavity from where the molten metal is floating in the casting cavity from the

It's also horizontal and uniform trapezoidal cross section to

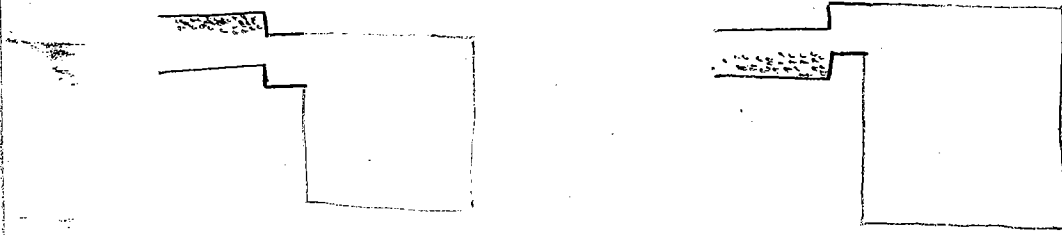

For high 's' metal casting the runner axis is made above the ingate axis so that any low density impurities present in the molten metal will be easily separated and stopped entering the casting cavity.

ii) During casting of low 's' metals the runner axis is provided below the ingate axis so that any high 's' impurities present in the molten metal will be collected at the bottom and stop entering into the casting cavity.

$$\text{offset} \leq 5\text{mm}$$

A_g - cross-sectional area of the ingate.

Gating ratio

$$\text{GR} = A_s : A_r : A_g$$

Accessories used in gating system for increasing the efficiency

Strainer :-

to remove the impurities (top of sprue)

Made by using ceramic material with high porosity

Splash core :-

Provided at bottom of the sprue to avoid the sand erosion from the bottom of the sprue.

Made by using ceramic material with low porosity.

Skim bob

Semi-circular cut given in the runner for separating the impurities present in the molten metal

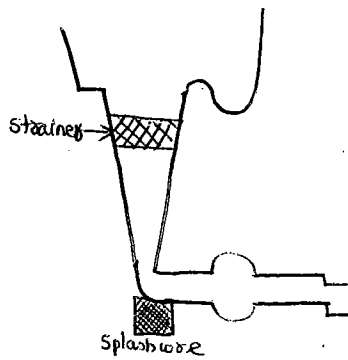

Classification of Gating system

① Based on pressure above the molten metal in pouring basin

- a) Non-preheated Gating System
- b) Preheated Gating System

② Based on position of INGATE

- a) Top gating system
- b) Bottom gating system
- c) Parting gating system
- d) Step gating system

a) Non-Preheated Gating System

If the pressure above the molten metal in the pouring basin = atm. pressure
It's known as non-preheated gating system.

It's very easy to maintain just by keeping the pouring basin open to the atmosphere.

But it cannot be used for casting of highly reactive metals like aluminium and magnesium because of oxidation problem.

Optimum gating ratio for non-preheated gating system is

1:4:4 or 1:2:2

b) Pressurised Chating system

If the pressure above molten metal in the pouring basin is greater than atmospheric pressure; it is called as pressurised gating system.

This is used in

- ① Casting of highly reactive metals; the top of the pouring basin is simply closed and the space above the molten metal in the pouring basin is filled by using inert gas at a pressure greater than atmospheric pressure. ($>$ atmos pres bez, then chance of air entering the closed pouring basin is less and only inert gas will escape).
- ② Some time the top of the pouring basin is closed due to some partial flow of molten metal is allowed in the gating system so that the air which is getting compressing in a casting cavity flowing in a backward direction and may collect on the top molten metal having pressure greater than atmospheric pressure known as back pressure chating system.
- ③ When ever the flow rate is to be increased in a gating system, the velocity of the flow of molten metal in the gating system has to be increased. But to increase the velocity without increasing the ht of the sprue (could be increased only upto the ht of top box); the only best method is to increase the pressure above molten metal in the pouring basin.

$$V = \sqrt{2gh + \frac{P - P_a}{\rho g}}$$

@ Top gating system

If ingate provided at the topmost part of the casting cavity; it is called top gating system.

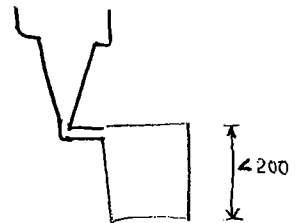

Bottom gating systems

$$P.T = \frac{\text{Vol}}{\text{flow rate}}$$

$$\begin{aligned} \text{flow rate} &= A_{\min} \times V_{\max} \\ &= A_{\max} \times V_{\min} \end{aligned}$$

$$A_{\min} = \min \text{ of } (A_s, A_r, A_g)$$

$$A_{\max} = \max \text{ of } (A_s, A_r, A_g)$$

$$V = \sqrt{2gh} = V_{\max}$$

$$\text{Flow rate} = A_c \times V_{\max}$$

$A_c \rightarrow$ check area

min of (A_B, A_G, A_C)

In case of top gate system - from the beginning to the end of the filling of the casting cavity, the velocity of the molten metal in the gating system is uniform and maximum.

\therefore the pouring time or filling time of molten metal into the casting cavity is as minimum as possible.

Preparing or making the top gating system is easier.

Limitation

Max. ht of cavities upto which the top gating systems can be used is 200mm only; beyond which the sand erosion will take place.

It cannot be used for filling the loose sand moulds.

(b) Bottom gating system

If the ingate is provided at the bottom of casting cavity.

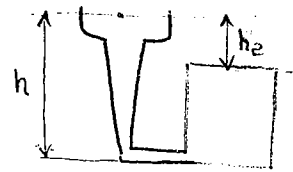

$$PT = \frac{Vol}{A_c \times V_{avg}}$$

$$V_{avg} = \frac{V_1 + V_2}{2}$$

$$V_1 = \sqrt{2gh}$$

$$V_2 = \sqrt{2gh_2}$$

dis adv:-

For same ht. of gating system & same volume of the cavity, the P.T required in the bottom gating system is higher than the top gating system.

Preparing or making a bottom gating system is difficult.

adv:-

No sand erosion takes place whatever be the ht. of cavity.

Cavities in the loose sand moulds can be filled very easily without any sand.

Q For the same pouring height and ~~low~~ depth of cavity is same = h.
 Then the ratio of P.T for bottom gating system to the P.T of the top gating system is ?

$$\frac{(PT)_b}{(PT)_+} = \frac{Vol}{A_{sec} \times (V_{avg})_b} \div \frac{Vol}{A_{sec} \times (V_{avg})_+}$$

$$= \frac{(V_{avg})_+}{(V_{avg})_b}$$

$$= \frac{\sqrt{2gh}}{\sqrt{2gh + 0}}$$

$$= \frac{2}{1}$$

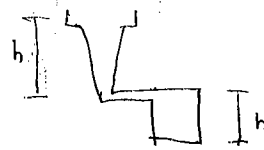

$h_2 = 0$

(c) Parting Gating system

If the ingate is somewhere near the middle of the casting cavity.

Pouring time - greater than top gating system
 less than bottom gating system

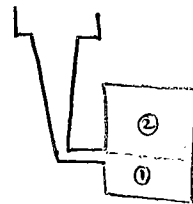

$$P.T = T_1 + T_2$$

$$= \frac{Volume}{A_{sec} \times V_{max}} + \frac{Volume}{A_c \times V_{avg}}$$

If gating is provided at exactly at middle - middle gating system

(d) Step gating system

To fill large casting cavity using the above gating system, the pouring time is required is very high. \therefore to reduce the pouring time more than one ingate is provided in the given horizontal gating system called as step gating system

If more than one ingate is provided at topmost part of casting cavity is called as top step gating system and so on...

If n ingates are used and the area of ingate is choke area; then multiply each area with n in the equation. i.e. A_c is replaced by nA_c .

In casting process; during calculation of pouring time - the loss of energy due to friction, bent losses, sudden expansion losses and sudden contraction losses etc can be assumed as negligible. Also the time taken for filling of molten metal into the riser is also neglected.

20-8-11
Saturday
9-1 pm

Aspiration effect:-

(Inhalation or breathing effect)

During pouring of molten metal into the casting cavity, somewhere along the gating system; if the pressure falls below atmospheric pressure because the outside pressure is atm pressure, the pressure difference is existing b/w outside and inside of the gating system; Due to this pressure difference; the air starts flowing from outside to the inside of gating system through porosity prop of moulding sand called as aspiration or inhalation or breathing effect.

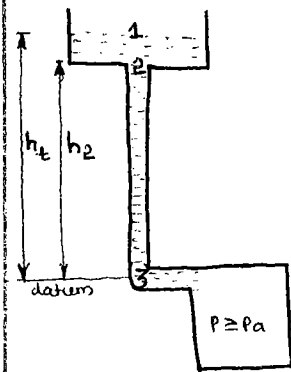

point 1 $P_1 \geq P_a$ - no aspiration effect

applying bernoulli's eqn [when using straight cylindrical sprue]

$$h_2 + \frac{v_2^2}{2g} + \frac{P_2}{\rho g} = h_3 + \frac{v_3^2}{2g} + \frac{P_3}{\rho g}$$

$$h_2 + \frac{P_2}{\rho g} = 0$$

$$P_2 = -\rho g h_2 \text{ (gauge)}$$

Thus if straight cylindrical sprue is used pressure at point 2 becomes -ve. gauge pressure. i.e. $<$ atm pressure.

Thus aspiration effect occurs at point 2

let $\frac{A_3}{A_2} = R$ [for removing the aspiration effect]

$$\text{Then } A_2 v_2 = A_3 v_3$$

$$\frac{A_3}{A_2} = \frac{v_2}{v_3} = R$$

$$v_2 = R v_3$$

applying bernoulli's eqn.

$$h_2 + \frac{v_2^2}{2g} + \frac{P_2}{\rho g} = h_3 + \frac{v_3^2}{2g} + \frac{P_3}{\rho g}$$

P_2, P_3 must be ≥ 0 (→)

$$h_2 + \frac{v_2^2}{2g} = \frac{v_3^2}{2g}$$

$$\frac{v_3^2 - v_2^2}{2g} = h_2$$

$$v_3^2 - R^2 v_3^2 = 2gh_2$$

$$v_3^2 (1 - R^2) = 2gh_2$$

$$(1 - R^2) = \frac{2gh_2}{v_3^2}$$

$$R = \sqrt{1 - \frac{2gh_2}{v_3^2}}$$

$$= \sqrt{1 - \frac{2gh_2}{2gh_1}}$$

$$v_3 = \sqrt{2gh_1}$$

$$R = \sqrt{\frac{h_1 - h_2}{h_1}}$$

equation of parabola

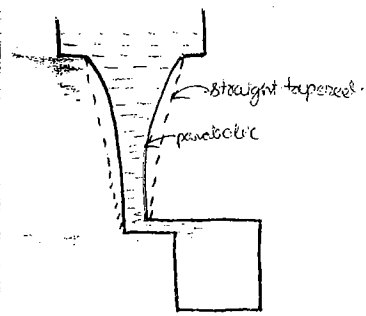

Thus if parabolic tapered sprue is used; it ensures that the pressure all along the length of the sprue is equal to '0' gauge pressure or atmospheric pressure and it eliminates the aspiration effect.

But making parabolic curvature sprue is difficult. ∴ the straight tapered sprue can be used.

But if straight tapered sprue is used at ends 2 and 3 $P = 0$ (gauge) but in between the pressure cross sectional area of the straight tapered sprue is greater than the parabolic sprue. ∴ the velocity is reducing and pressure is increasing. Thus it also eliminates the aspiration effect.

Solidification

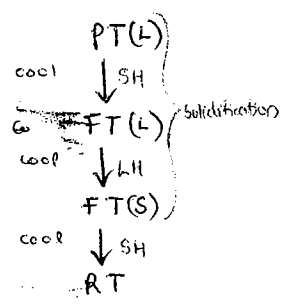

For solidification of the molten metal; it is required to remove the heat for only 1st two stages of cooling.

$$\therefore \text{Heat to be removed for solidification} = m(S \cdot H + L \cdot H)$$

$$\text{Heat to be removed} = V \rho (C_p(T_p - T_c) + LH)_{m - \text{mass of casting}}$$

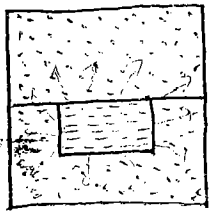

For solidification of molten metal in the casting cavity, the heat transfer through the mold is taking place based on unsteady state heat conduction with infinite wall thickness problem.

heat transfer rate

$$H.T = \frac{A_s K \Delta T}{\sqrt{\pi \alpha \tau}}$$

A_s - surface area
 K - thermal conductivity
 ΔT - temp difference
 α - thermal diffusivity
 τ - time

solidification time τ $\frac{1}{2}$

$$\tau = \frac{V S (c_p(T_p - T_f) + L)}{A_s K \Delta T} \sqrt{\tau \alpha \pi}$$

$$\sqrt{\tau} = \left(\frac{V}{A_s}\right) \left[\frac{S (c_p(T_p - T_f) + L)}{K \Delta T} \sqrt{\pi \alpha} \right]$$

$$\tau = \left(\frac{V}{A_s}\right)^2 \left[\dots \right]^2$$

$$= \left(\frac{V}{A_s}\right)^2 K_1$$

K_1 - mold constant

$$\tau = K_1 M^2$$

$$M = \frac{V}{A_s}$$

Q:- If casting C_1 of dim $200 \times 100 \times 70$ mm solidifies in 10 minutes.
Then casting C_2 of dim $200 \times 100 \times 10$ mm solidifies in ?

$$\frac{\tau_2}{\tau_1} = \left(\frac{M_2}{M_1}\right)^2 \quad \text{At similar conditions } K_1 = K_2$$

$$\tau_2 = \tau_1 \times \left(\frac{V_2 \times A_{s1}}{V_1 \times A_{s2}}\right)^2$$

$$= \tau_1 \times \left[\frac{200}{70} \times \frac{2(200 \times 100 + 100 \times 70 + 70 \times 200)}{2(200 \times 100 + 100 \times 10 + 10 \times 200)} \right]^2$$

$$= 10 \times \frac{1}{7} \times \frac{41}{23}$$

When the solidification process is over, need not be required to wait to become room temp. but we could immediately break the mould and take the casting.

Slush casting

It's an open casting process in which the liquid molten metal is poured into the casting cavity in open condition, allow it to solidify for some time, invert the mould immediately so that un-solidified molten metal is falling down leaving the solidified material on the side of the mould. Now by breaking the mould the casting can be taken out.

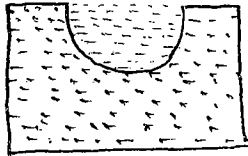

①

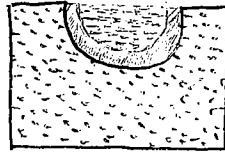

②

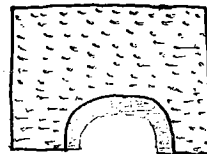

③



④

Used for producing decorative shapes like lamp shades, Christmas tree etc.

Since any oxides produced would float on the surface - it would be removed while inversion.

$$\tau \propto M^2$$

for small thickness $\left(\frac{V}{A_s}\right)_{\text{thin}} \approx t$

$$\tau \propto t^2$$

$$t \propto \sqrt{\tau}$$

$$t = C_1 \sqrt{\tau} + C_2$$

C_1 and C_2 are constant which can be found by experimentation.

$$\tau_1 = x \rightarrow t_1 = ?$$

$$\tau_2 = y \rightarrow t_2 = ?$$

then

$$t_1 = C_1 \sqrt{\tau_1} + C_2$$

$$t_2 = C_1 \sqrt{\tau_2} + C_2$$

solve

$$C_1 = ? \quad C_2 = ?$$

eg:- $\tau_1 = 20 \quad t_1 = 3$

$\tau_2 = 50 \quad t_2 = 4.5$

$\tau_3 = 100 \text{ sec} \quad t_3 = ?$

ans: $t_3 = 6.2 \text{ mm}$

hint:- 1st find C_1, C_2

Settling :-

The operation of breaking the mould and taking out the casting is called settling.

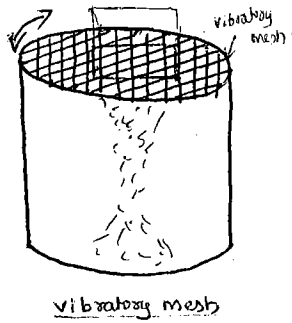

The mold which is to be broken is kept over a vibrating mesh,

Due to the vibrational forces, the mold will be broken & the broken pieces of mould is falling into pit leaving mold boxes and casting over the mesh.

Once the complete mould is found to be broken, the mould boxes could be send to remoulding and casting to the inspection.

Inspection

① Dimensional inspection

only one or two castings would be inspected dimensionally and qualify the pattern. Afterwards dimensional inspection is not req.

② Defective inspection

Every casting must be inspected for the presence of defects in the casting.

Non-destructive testing is only used. [destructive testing is only to inspect the mechanical properties]

③ Coin testing :-

Take a coin hit, check the sound

simplest easiest and fastest methodology - but needs lot of experience.

④ Ultrasonic Testing :-

① Through transmission technique :-

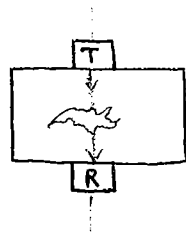

A transmitter and receiver is present

If the magnitude of the signal received by the receiver is compared with the magnitude of signal transmitted by the transmitter and loss of signal is determined.

$$\text{if } \boxed{\text{loss} < 5\%}$$

assumed as No defect or presence of defect are smaller in size.

lim:-

Not give information about the location of the defect
∴ pulse echo technique could be used.

② Pulse Echo Testing :-

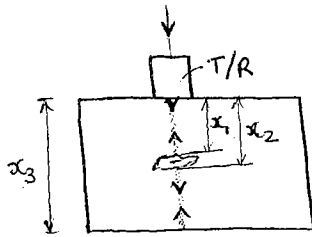

In PET the probe 1st acts as a transmitter so that it produces ultrasonic signal.

Whenever density variation is observed in the passage - some amount of sound signal would be reflected back and the remaining is transmitted.

So that when the probe is acting as receiver it's measuring the time interval b/w the transmitted signal and 1st received signal, transmitted and received signal and so on...

$$V_s = \frac{2x_1}{T_1} \Rightarrow \boxed{x_1 = \frac{V_s \times T_1}{2}}$$

$$x_2 = \frac{V_s \times T_2}{2}$$

Lim:-

Nature of defect could not be obtained

③ Radiography (X-ray)

During radiography of casting a film is obtained.

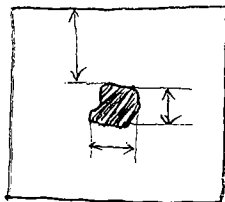

X-ray film

By observing the color variation in the film the presence of defect could be estimated.

If pure black coloured patch present in film - high density inclusion

pure white coloured patch

- blow hole or void

light white coloured patch

- low density inclusion.

By measuring the dimensions of the patch and by dividing by magnification factor will give the size of the defect and its location.

Lim:-

↳ Highly costly

↳ Carcinogenic process. (thick walled dm) are used

only critical components (aerospace, aircraft) - its used.

Riser Design :-

Riser is acting as a reservoir for supplying the molten metal to the casting cavity to compensate the liquid shrinkages taking place during solidification.

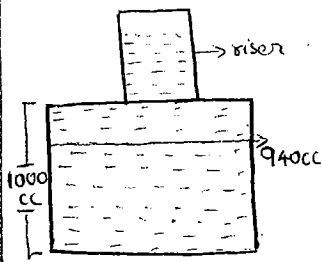

of 6% shrinkage

to supply additional 40cc riser is used.

Conditions

- ① Volume of riser > Vol. of shrinkage

$$V_r \geq 3 V_{sc} \quad \text{necessary condition.}$$

- ② To ensure the molten metal supply from riser to cavity the solidification time of molten metal in the riser must be greater than or equal to solidification time of casting

$$T_{sr} \geq T_c$$

- ③ Location of riser

- ④ Shape of riser

Selected such that surface area of the riser exposed for heat transfer must be as min as possible. So that the solidification time of molten metal in the riser must be as maximum as possible.

$$T_s \propto \left(\frac{V^2}{AS} \right)$$

For a given volume; choose

the surface area exposed for heat transfer is minimum with cylindrical shape of the riser, the next minimum is the spherical shape of the riser.

- ∴ best preferable shape of the riser is cylindrical.
next preferable shape is spherical.
But never prefer the rectangular or cubical shape of the riser.

For given volume of riser - it is possible to determine the dimensions of a spherical riser easily. But for the case of cylindrical riser - to determine the dimensions of a riser; it is required to have the relationship b/w dimensions of the cylinder.

Types of risers

① Top cylindrical riser :- (top riser)

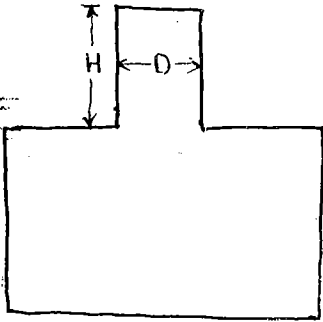

$$V = \frac{\pi}{4} D^2 H \Rightarrow H = \frac{4V}{\pi D^2}$$

$$A_s = \pi D H + \frac{\pi}{4} D^2$$

$$= \pi D \frac{4V}{\pi D^2} + \frac{\pi}{4} D^2$$

$$A_s = \frac{4V}{D} + \frac{\pi}{4} D^2$$

For minimum A_s

$$\frac{d(A_s)}{d(D)} = 0$$

$$\frac{d(A_s)}{d(D)} = -\frac{4V}{D^2} + \frac{\pi}{4} D = 0$$

$$\Rightarrow -4 \frac{\pi D^2 H}{4 D^2} + \frac{\pi}{4} D = 0$$

$$4H = D$$

$$D = 2H$$

$$H = \frac{D}{2}$$

modulus

$$M_{top} = \frac{V}{A_s}$$

$$= \frac{\frac{4}{3} \pi R^3}{4 \pi R^2}$$

$$= \frac{R}{3}$$

$$M_{top} = \frac{D}{6}$$

② Side cylindrical riser :- (side riser)

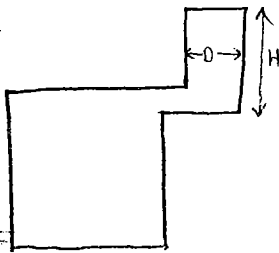

$$V = \frac{\pi}{4} D^2 H \Rightarrow H = \frac{4V}{\pi D^2}$$

$$A_s = \pi D H + 2 \times \frac{\pi}{4} D^2$$

$$= \frac{4V}{D} + \frac{\pi}{2} D^2$$

For minimum area

$$\frac{dA_s}{d(D)} = 0$$

we get $D = H$

modulus

$$M_{side} = \frac{V}{A_s}$$

$$= \frac{\frac{\pi}{4} D^2 H}{\pi D H + 2 \frac{\pi}{4} D^2}$$

$$M_{side} = \frac{D}{6}$$

③ Spherical Riser

modulus

$$M_{spherical} = \frac{V}{A_s}$$

$$M_{sp} = \frac{D}{6}$$

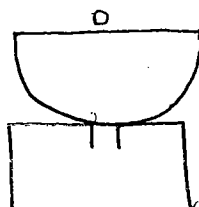

$$V = \frac{\pi}{4} D^3$$

* For all the three types - Top, side and spherical - the modulus are same and $= \frac{1}{2}$

Methods of riser Design

- ① Chenes method
- ② Modulus method
- ③ Novel Research method
- ④ Shrinkage volume

① Chenes method

Freezing ratio $X = \frac{M_r}{M_c}$

$$X = \frac{(V/A_s)_r}{(V/A_s)_c} \quad \text{--- ①}$$

$$X = \frac{a}{y-b} - c \quad \text{--- ②}$$

$$\text{①} = \text{②}$$

$$\frac{(V/A_s)_r}{(V/A_s)_c} = \frac{a}{y-b} - c$$

$$\frac{\frac{D}{6}}{(V/A_s)_c} = \frac{a}{\frac{V_r}{V_c} - b} - c$$

$$\frac{(D/6)}{(V/A_s)_c} = \frac{a}{\left(\frac{\pi D^2 H}{4 V_c}\right) - b} - c$$

by knowing the relation b/w D and H - only unknown is D.
 Thus find 'D' and then using relation find H.

()_r - riser

()_c - casting

a, b, c are constants - can be taken from the casting data corresponding to metal to be casted

y - volumetric ratio. $= \frac{V_r}{V_c}$

$$V_r = \frac{\pi D^2 H}{4}$$

② Modulus method

$$T_r \geq T_c$$

$$(M_r)^2 \geq (M_c)^2$$

$$M_r \geq M_c \Rightarrow 20\% \text{ extra (assume)}$$

$$\frac{D}{6} \geq M_c$$

$$D \geq 6 M_c$$

$$D = 6 M_c$$

$$\boxed{D = 7.2 M_c}$$

$$M_r = 1.2 M_c$$

$$\frac{D}{6} = 1.2 M_c$$

$$D = 7.2 M_c$$

then find H

③ Novel Research :-

Shape factor $SF = \frac{L+W}{z}$

L - length of casting
 w - width of casting
 z - thickness of casting

After calculating the shape factor - by using casting data book corresponding to value of shape factor. The volumetric ratio can be taken from the table

Using the volumetric ratio. The dimensions (D and H) of the riser can be calculated

SF	$y = V_r/V_c$
-	-
-	-
-	-

$$y = \frac{V_r}{V_s} \Rightarrow V_r = y V_s$$

$$V_r = \frac{\pi D^2 H}{4}$$

find D = and H =

* Here only shape factor is been asked in exams

eg:-

SF ; Rectangular casting = $\frac{L+b}{h}$ = $\frac{L+b}{h}$

SF ; solid sphere = $\frac{D+D}{D}$ = 2

SF ; hollow cylinder = $\frac{L+D}{D}$ =

SF ; Hollow cylinder = $\frac{L+W}{z}$

④ Shrinkage volume :-

let V_c - volume of casting

a = % shrinkage

V_{sc} = shrinkage volume

$$= \frac{a}{100} \times V_c$$

$$V_r \geq 3 V_{sc}$$

$$V_r = 3 V_{sc} = \frac{\pi D^2 H}{4}$$

D =

H =

check whether

$$T_r \geq T_c \rightarrow \text{satisfied } D, H$$

If not, $T_r = T_c$

$$m_r = m_c \Rightarrow D' = 6 m_c$$

$D' =$ -

3 total diam of center.

If the dimensions of a riser is calculated based on sufficient condition, it always automatically satisfies the necessary condition also.

If the dimensions of a riser is calculated directly by using sufficient condition no doubt it will satisfy the necessary condition also; but it may or may not ensure the optimal size of the riser.

Q Casting of $15 \times 15 \times 15$ cm cube having % shrinkage 6% , $V_s \geq 3V_c$.
Design the riser by shrinkage volume (top cylindrical)

$$V_c = 15 \times 15 \times 15 \text{ cc}$$

$$V_{sc} = \frac{6}{100} \times 15 \times 15 \times 15 =$$

$$V_s = 3 V_{sc} \\ = 3 \times \frac{6}{100} \times 15 \times 15 \times 15$$

$$\frac{\pi}{4} D^2 H = 3 \times \frac{6}{100} \times 15 \times 15 \times 15$$

Top cylindrical so $H = \frac{D}{2}$

$$\frac{\pi}{8} D^3 = \frac{3 \times 6 \times 15 \times 15 \times 15}{100}$$

$$D^3 = (15 \times 15 \times 15) \times \frac{3^2 \times 2}{\pi \times 100}$$

$$D = 30 \sqrt[3]{\frac{3^2 \times 2}{\pi \times 100}}$$

$$= \underline{\underline{11.56}}$$

$$T_s \geq T_c \Rightarrow m_s \geq m_c \Rightarrow \frac{D}{6} \geq m_c$$

$$\frac{11.56}{6} \geq \frac{15}{6} \Rightarrow \text{not satisfied.}$$

$$T_s = T_c \Rightarrow m_s = m_c$$

$$D = 6 m_c$$

$$= 6 \times \frac{15}{6} = \underline{\underline{15}}$$

Note:-

only in the lost shrinkage volume method both necessary & sufficient conditions are checked (rather satisfied)

In all the 3 other methods it's not necessary as the constants or tables from the data book ensure the satisfaction of both necessary and sufficient conditions.

Q what is the maximum length of casting which could be produced by using a single top riser: (only for this and plate like design)

(1) with out end wall effect

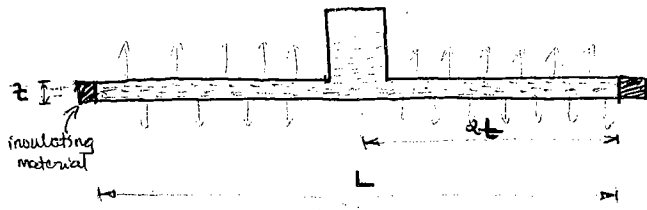

$$L = 4t$$

$2t \Rightarrow$ Riser gradient

(2) with end wall effect

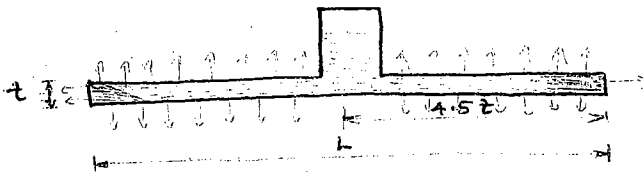

$$L = 9t$$

$2t \Rightarrow$ Riser gradient

$2.5t \Rightarrow$ End wall effect gradient

(3) with chills

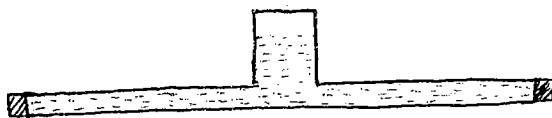

$$L = 9t + 100\text{mm}$$

$2t \Rightarrow$ Riser gradient

$2.5t \Rightarrow$ End wall effect gradient

$50\text{mm} \Rightarrow$ Chill gradient

TWO RISERS

(1) with out end wall effect

$$L = 8t$$

(2) with end wall effect

$$L = 13t$$

(3) with end chills

$$L = 13t + 100\text{mm}$$

(4) with end and central chill

$$L = 18t + 200\text{mm}$$

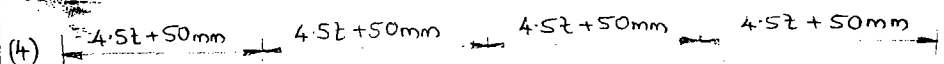
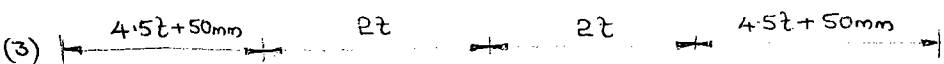
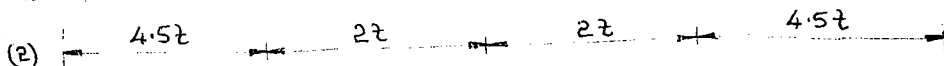
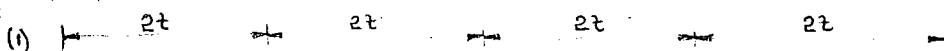
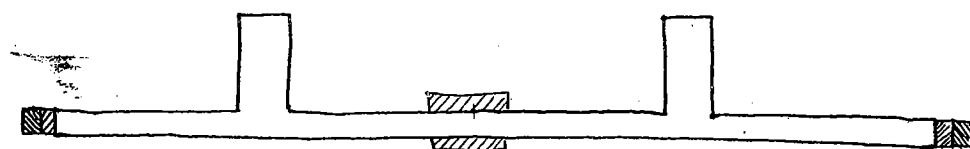

23/8/11
Tuesday
6-9 am

Special Casting Process

① Slush Casting

② Shell Mold Casting

In this the mould is made like a shell i.e. a thin or hollow mould can be made.

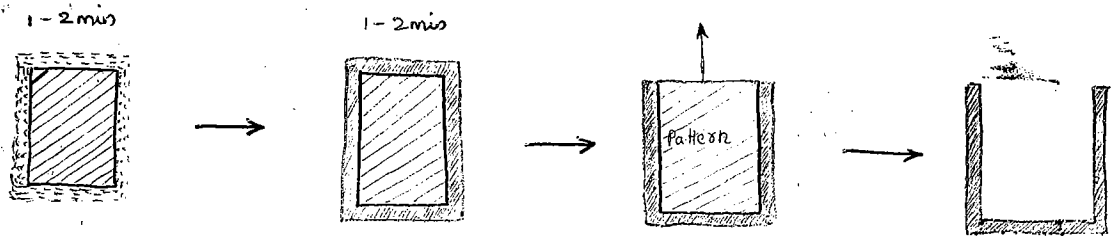

Phenolic resin - liquid - $\mu = 1500$ to 2000 Cp

Dip the pattern in phenolic resin and keep it for 1-2 minutes

Take out the pattern and keep it in furnace @ 300°C for 1-2 minutes

Take out the pattern and remove the top layer of phenolic resin

Remove the pattern

Features

Handling of the mould is easier

Production rate is high (only 1-2 min dip, 1-2 min)

Time taken to produce 1 mold is about 5 minutes

The process can be completely automated or mechanised

No necessity of the mold material

Used for producing circular and symmetrical shape of the mould.

Components produced

cylinder and cylinder heads of IC engine, automobile transmission part, bearing, crank shaft, bevel gear, gear blank.

③ Investment Casting

Wax can be used as a pattern material.

Complex and intricate shape of the castings can be easily produced

Removal of pattern would be easier in the form of a liquid.

Surface finish produced in casting would be very good.

Only upto 5 kg casting could be produced.

It is the length of the casting which could be produced with

a single

The mould is made by using cement concrete as a mould material.

Bcz of cement concrete mould - same mold can be used for producing more than one casting. \therefore it's called semi-permanent mould casting.

Cement concrete is having high thermal conductivity than sand mould. Heat transfer rate will be higher and surface hardening heat treatment effect would be taking place in casting. \therefore the castings produced by investment casting process would always have hard surface and soft interior.

eg:- Gold & Silver ornaments, Turbine blades, wave guides for radar system; shuttle eye for weaving technology, Surgical instruments etc.

④ Die Casting Process

Mould is made by using metal - So mould is also called as die

Die steel or tool steel can be used

Excellent surface finish is possible since we use metal moulds as metal moulds itself would have excellent surface finish. So no-machining is required after casting.

Bcz of melting of mould when high temp molten metals are poured into the cavity, this process could be used for casting of only low MP materials like Pb, Sn, Al, cadmium etc.

To avoid adhering of solidified molten metal to the mould or casting cavity, the silicon powder must be sprinkled on the surface of the cavity before pouring the molten metal into the cavity.

Bcz of no porosity property of mould - the air present in the casting cavity could be removed by using 'through risers' instead of blind risers

⑤ Gravity Die Casting

If the flow of molten metal into the casting cavity is due to the gravitational force - then it's called as gravity die casting

Bcz the molten metal cannot flow into each and every corner of the complex shape of the cavity, the gravity die casting cannot be used for casting of complex shapes of the casting and can be used only for simple

eg:- IC engine piston made by using Al alloy.

⑥ Pressure die Casting

If external pressure is used for the flow of molten metal into the casting cavity - it's called as pressure die cast.

By of the ext. pressure the flow of molten metal into each & every corner of a complex shape of a casting can be easily possible. \therefore pressure die casting can be used for producing complex shape of casting.

eg:- Carburetor body made of Al alloy.

⑤ Centrifugal Casting Process

The centrifugal force produced due to the rotation of the mould can be used for distributing the molten metal around the circumference of the mould. The rotation of the mould would be continued until the molten metal get solidified. Now break the mould and take out the casting.

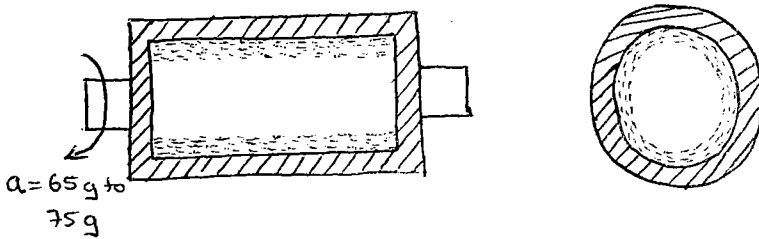

Mainly used for producing large sized hollow casting without using the core.

For sound casting the accel. used is 65-75g.

$$F_c = m a = m r \omega^2 = m \frac{D}{2} \left(\frac{2\pi N}{60} \right)^2$$

$$a = \frac{D}{2} \left(\frac{2\pi N}{60} \right)^2$$

$$N^2 D = \frac{a \times 2 \times 60^2}{4 \pi^2} = \text{Constant}$$

$$N = \sqrt{\frac{\text{const}}{D}}$$

$$N^2 D = \text{const}$$

since centrifugal force $\propto g$ - any low density impurities present in the molten metal will be collected at the center of the casting, which can be removed after the casting process.

In general the centrifugally casted components would have poor mechanical properties (this is because of segregation or separation).

due to density variation ($\rho_{Fe} = 8g/cc$, $\rho_C = 1.4g/cc$ in steel) more centrifugal force is on iron and thus iron gets moved to outward - producing layered structure.

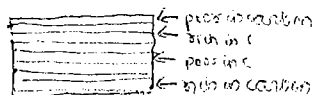

It's not homogeneous. It's not machinable.

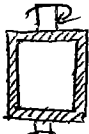

If the model is vertical - to produce sound casting
1500 to 2000g is req.

$a = 1500g$
to $2000g$

So in general centrifugal casting is done only with horizontal axis of rotation.

If the axis of rotation and axis of the mould are coinciding - it's called as true centrifugal casting process and it produce uniform thickness of casting around the circumference.

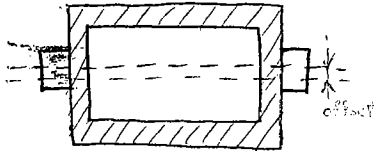

eccentric or semi-centrifugal casting are also used to produce non-uniform thickness of casting.

Uses of centrifugal casting

↳ produce large sized pipes without using the core (city water pipes)

Casting Defects

① Blow or blow hole

The air or gas bubble (large sized) present inside the casting is called blow or ~~flow~~ blow hole.

Reasons :-

- low porosity property of the moulding sand.
- following partial flow of molten metal in gating system
- allowing aspiration effect in the casting process (etc)

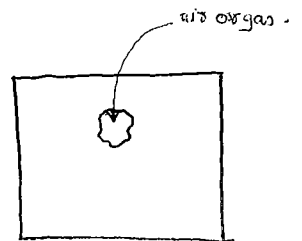

② Scars

The presence of air or gas bubbles on the surface of the casting.

- It's not that much problem and may even not be considered as a defect bcz it would be removed by machining
- Reasons are same as that of blow hole.

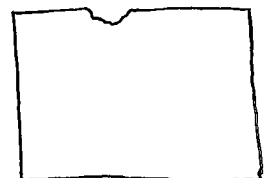

③ Blister

The presence of air or gas bubbles near to the surface of casting

Reasons are same as blow hole.

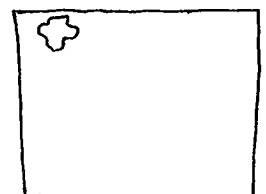

④ Porosity :-

Small sized air or gas particles present inside the casting

Reasons same as that of blow hole.

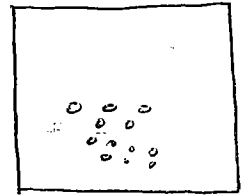

⑤ Dross

Presence of impurities inside the casting

Mainly caused due to improper separation of impurities present in the molten metal.

Avoided by using strainer, skim bob, offsetting the axis of runner and ingate etc.

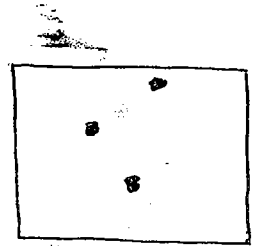

⑥ Inclusion or Sand Inclusion :-

The presence of sand particles inside the casting

Mainly bcz of sand erosion taking place during casting.

This is due to the turbulent flow in gating system.

- Using top gating system for the cavities having ht. > 200mm
- Using top gating system for filling loose sand moulds etc.

⑦ Void or Shrinkage cavity

The open space produced in the casting due to the

non availability of molten metal for compensating

the liquid shrinkage taking place during solidification.

could be eliminated by using chills.

⑧ Misrun :-

Non filling of the projected portion of a casting cavity using the molten metal.

bcz of solidification before complete filling of the casting cavity.

This can be eliminated either by reducing pouring time of molten metal into the cavity or increasing degree of superheat of molten metal.

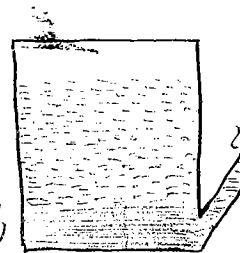

⑨ Rat tail :-

tail like elements produced on the surface of a casting.

produced when wax patterns used with green sand mould.

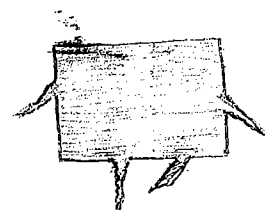

⑩ Shift :-

When multi-piece patterns are used there may be a mismatch between the cavities of cop and drag boxes which produces the shift defect.

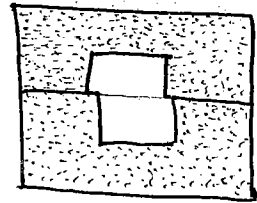

It can be reduced by using dowel pins

⑪ Cold shut

The discontinuity produced in the casting due to indirect contraction ; its

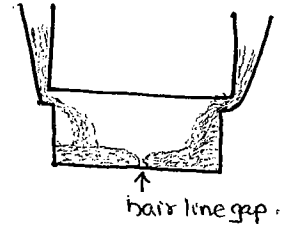

WELDING

Books :-

- Welding Technology by Little [gas]
- Welding Technology by Parm [electrical and resistance welding]
- Welding Technology by Quansiburg

Welding definition :-

the process of joining two or more similar or dissimilar metals with or without the application of heat, with or without the application of filler material and with or without the application of pressure.

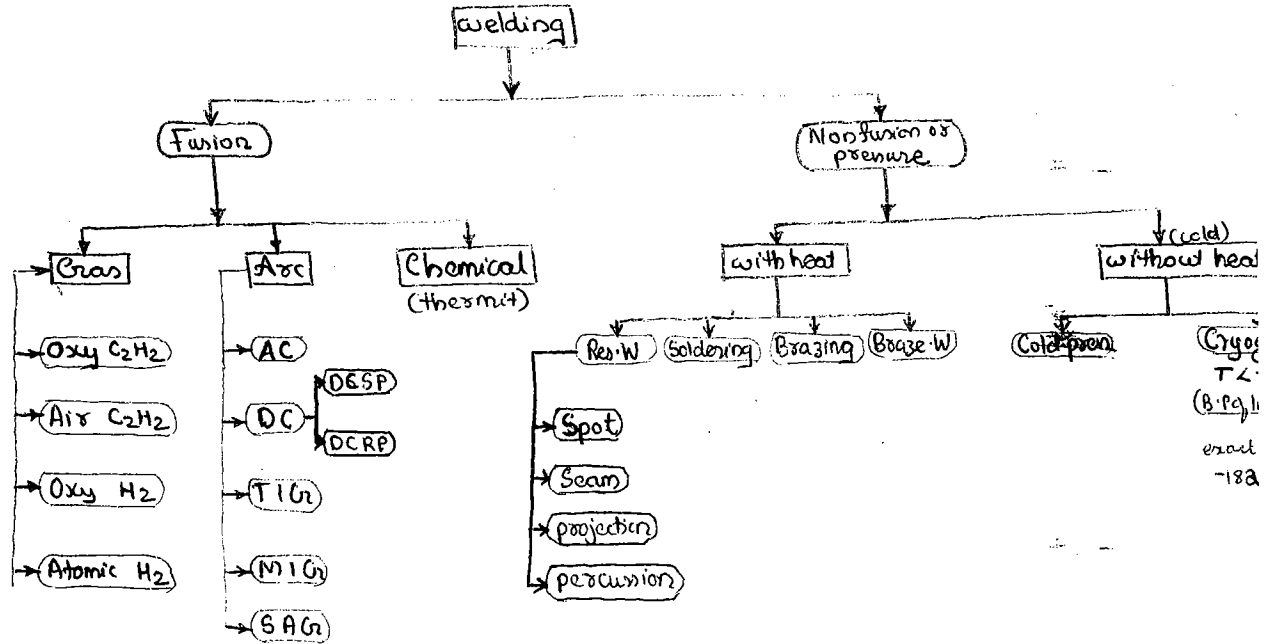

preheating & post heating

weldability of metals

welding metals.

Fusion welding process

With the melting of parent material, the joint is produced

Non fusion or Pressure welding process

Without the melting of parent material or with application of pressure - joints are produced

Gas welding

By burning of gas - if the heat req. for melting of metal is obtained.

ARC welding

Due to the electrical arc - the heat is obtained

Chemical welding

Due to exothermic chemical reaction heat for melting of plates is obtained.

Oxy-Acetylene Gas welding :-

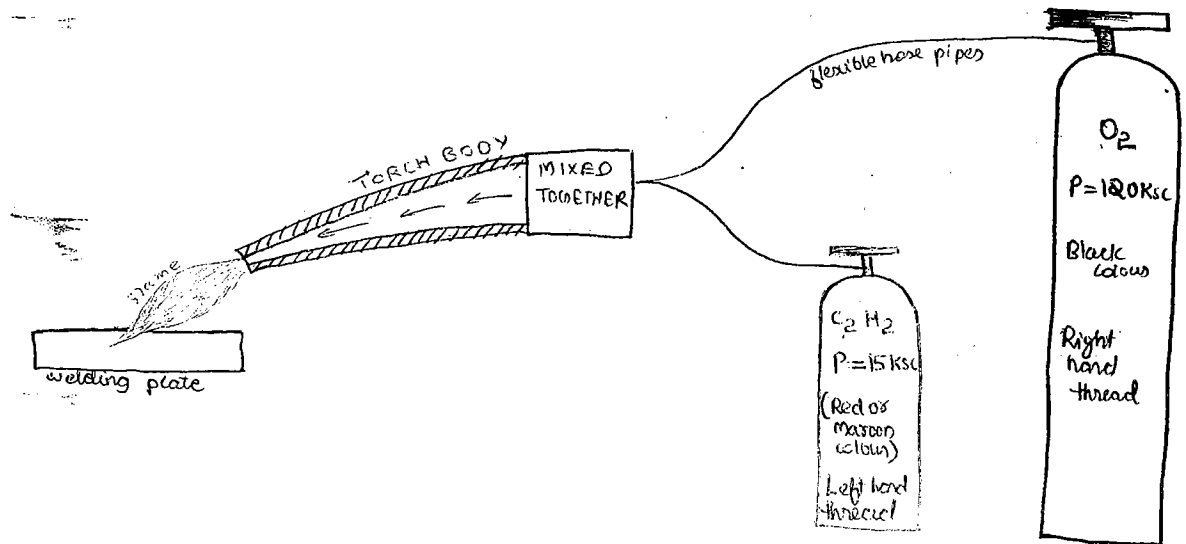

The oxygen and C_2H_2 will be drawn from their respective cylinders into the torch body, mixed them together in the torch body.

The mixture is possessing certain higher pressure, when this high pressure mixture is passing through the convergent nozzle the pressure energy is converted into velocity energy.

\therefore the mixture is coming out at high velocity

When this mixture is given initiation or burning - the continuous flame will be produced so that the heat available in the flame can be used for melting of plates and joining.

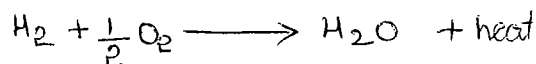
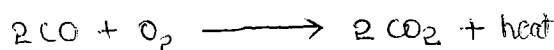
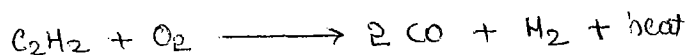

For complete combustion of 1 unit vol of acetylene, 2.5 units of vol of O_2 are required out of which 1 unit vol of O_2 is obtained from O_2 cylinder and 1.5 unit vol of O_2 is obtained from atmosphere.

Based on the amount of O_2 consumed from the O_2 cylinder, the flame produced is divided into three types.

① Neutral Flame

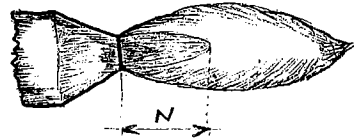
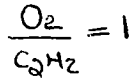

$N = 10$ to 15 mm

Inner and outer cone would be distinguished by their colors:

Inner cone - red or yellow - incomplete combustion
 Outer cone - blue colour - complete combustion

Maximum temp is at the intersection of inner and outer cone [inside incomplete combustion; outside radiation, convective loss]

Maximum temp at intersection = $3260^\circ C$

Average temp produced in flame = $2000 - 2100^\circ C$

[during burning large qty of H₂O produced. To evaporate the water large amount of heat is carried away by the water hence temp is reduced by 1/3rd.]

Application:-

Used for cutting and joining of all ferrous and non ferrous materials except brass (during welding of brass, the zinc present in the brass gets evaporated. hence neutral flames should not be used)

② Oxidising Flame

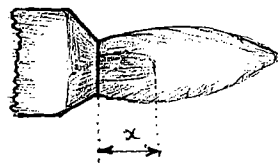
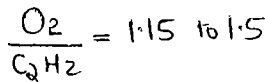

$x = \frac{N}{3}$ to $\frac{N}{2}$

Because of excess amount of O_2 drawn from the O_2 cylinder. The distance to be travelled by the flame for complete combustion is less. \therefore length of the inner cone will be small.

Slightly lean mixtures would be having maximum η (so in I.C. engine)

$T_{max} = 3380^\circ C$

$T_{avg} = 2100$ to $2200^\circ C$

Application:-

Because of excess amount of oxygen of O_2 is supplied from O_2 cylinder, there is a possibility of free oxygen in the flame. This produces metal oxides during joining of highly reactive

metals like aluminium, Mg etc.

bcz of higher average Temp of flame - high M.P materials could also be joined by using this process.

This can be used for joining of all ferrous & non ferrous metals including brass. (using oxidizing flame; bcz of presence of excess amount of O_2 in the flame, this O_2 combines with some quantity of Zn present in the brass and produces Zn oxides. which floats over the weld pool & not allow (ferrous oxide) rem. Zn to evaporate)



③ Carburizing or Reducing flame

$$\frac{O_2}{C_2H_2} = 0.85 \text{ to } 0.95$$

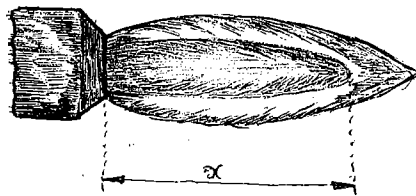

$$x = 2N \text{ to } 3N$$

Bcz of short supply of O_2 from the cylinders, for complete combustion of the acetylene, the flame has to travel for a longer distance and length of the inner cone is $2N$ to $3N$

Bcz of longer length of the cone; the heat energy lost by convection and radiation is very high. \therefore the maximum and avg temp. are reduced.

$$T_{max} = 3040^\circ C$$

$$T_{avg} = 1800 - 1900^\circ C$$

Bcz of lower average temp of flame very high M.P materials cannot be joined.

Application :-

Bcz of short supply of oxygen; the free carbon may present in the flame so that if this flame is used for joining of ferrous materials, the carbon may be absorbed by the iron and produces such as carbon and changes the mechanical properties.

\therefore carburizing flame should not be used for joining of ferrous materials.

It's most commonly used for joining of high carbon steel.

In case of steel - with increase of carbon content - M.P reduces

\therefore high carbon steels will have low M.P. and the high carbon steel will be already saturated with carbon. Thus even though free carbon is present in the flame - it cannot be absorbed by the high carbon steel.

So high carbon In case of cast iron - $\pi C \rightarrow$ M.P \uparrow

24-8-2011
6-9 am

Hose :-

Hose connecting O₂ cylinder to the torch body; Copper hose can be used. It has a capability to withstand high pressure and also has flexibility. If Cu hose pipes is used for connecting acetylene cylinder, Cu can chemically react with acetylene and produce paste like material and pipe will fail. Hence Cu pipes cannot be used for connecting acetylene cylinder. Thus no interchangeability of hose pipe is possible.

∴ for withstanding low pressure (15 kg/cm²), cheaper materials can be selected for connecting acetylene cylinder. So we used rubber/plastic materials.

To avoid the interchangeability of the hose pipe; the size, colour and the thread distribution can be used.

Torch angle :-

Angle b/w the axis of the torch and axis of workpiece is called as torch angle.

$$TA = 0 - 90^\circ$$

With increase of torch angle; the area to which the flame is exposed to the weld bit is reduced. ∴ the flame density will increase.

$$\text{Flame density} = \frac{\text{heat supplied}}{\text{Area}}$$

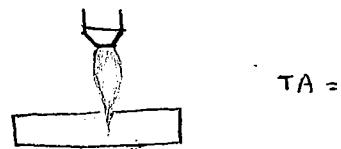

Factors affecting torch angle

① Thickness of plate

As thickness increases, amount of heat to be supplied per unit area of the weld bit is increasing. Hence the torch angle is to be increased.

② M.P of plates to be joined :-

As M.P of plates is increasing - heat supplied for unit area has to be increased. ∴ the torch angle has to be increased.

③ Thermal conductivity of plates :-

As the thermal conductivity of plates is increasing, the heat transfer for unit area by conduction is increased and net heat available at the joint is reducing. ∴ To compensate this loss of heat the higher torch angle is to be used.

④ Place of welding

In perspective of the above factors; Use large torch angle at the beginning of the welding and small torch angle at the end of the welding. In the beginning the temp of plate is at room temp; to raise the plate to M.P.

large amount of heat is to be supplied. for this large torch angle should be used.

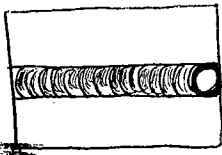

at the end of the welding, if small torch angles are used, the force of flame is obstructing the overflow molten metal and eliminates the crater defect at the end of the welding.

WELDING TECHNIQUES (gas welding)

- 1 Forehand or left hand welding technology (LHWT)
- 2 Back hand or right hand welding technology (RHWT)

method of focussing of flame on to the weld plate can be used as a basis for deciding the type of weld technique

If the flame is focussed towards the non-welded portion it's forehand welding technique.

If the flame is focussed towards the already welded portion is called back hand welding technique.

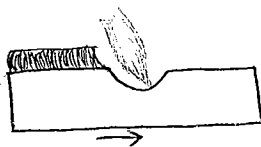

forehand welding technique
(irrespective of direction)

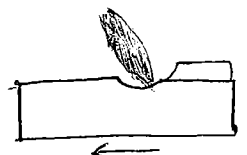
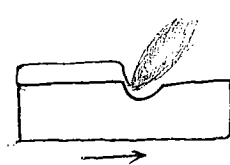
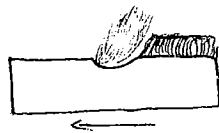

back hand welding technique

In practice most of the welders found that the forehand welding technique is more efficient and effective if it is done from right to left direction

and backhand welding is found to be more effective & efficient is done from left to right direction.

In forehand welding technique bcz of the flame focussed towards non-welded portion, the preheating of the welding edges will take place where as in case of backhand welding technique bcz the flame is focussed towards the already welded portion, the forced heating of the weld ^{bead} take place.

In forehand w.t the force of flame is pushing back the molten slag particles into the weld pool. \therefore some of the molten slag particles may remain inside the weld bead which reduces the strength of the weld bead and it also

produces non uniform slag layer over the weld bead. which promotes atmospheric contamination of the weld bead -
 In case of blow the force of flame is pushing out the molten slag particle from the weld pool. \therefore no slag particles are present in the weld bead and uniform slag layer is formed over the weld bead.

Application

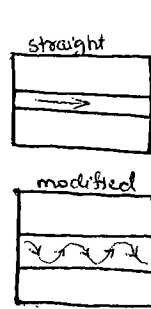

forehand

Joining of plates upto 4mm thickness in single pass welding using straight movement of the torch and upto 6mm thicker can be welded by single pass by modified movement of the torch.

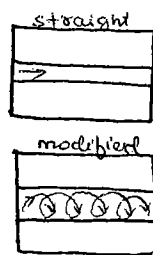

back hand

The back hand welding techniques could be used by joining plates upto 6mm thickness with single pass welding with straight movement of the torch and upto 15mm thickness plates in single pass welding using modified movement of torch.

Welding Positions

- ① Horizontal or flat w.p
- ② Vertical welding position
- ③ Horizontal Vertical
- ④ Overhead

① Horizontal or flat plate welding Position

$t \leq 4\text{mm}$ Forehand or Back hand with
 $t = 4-6\text{mm}$
 $t = 6-15\text{mm}$ Back hand with
 $t > 15$ Multipass

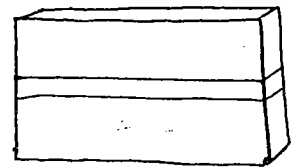

② Vertical welding position

Always from bottom to top

Always

If forehand welding Tech is used, the force of flame act as an additional force for holding the molten metal particles without falling.

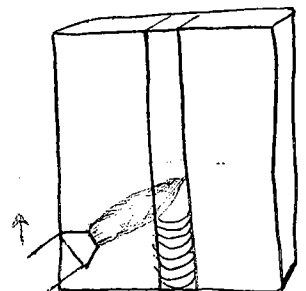

③ Horizontal Vertical

An horizontal vertical position since plates are vertical; molten metal try to fall down; the force of flame acting by the back hand welding technique can act as an additional force holding the molten metal particles in position. So back hand is used.

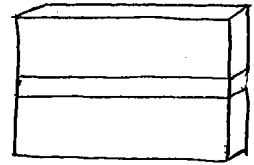

④ Overhead

Bcz of surface tension; b/w the solid body and molten metal, the molten metal is kept in position without falling. If back hand welding technique is used; the force of flame is acting as an additional force. \therefore uniform weld bead can be produced. whereas with forehand welding technique some of the molten metal particles try to fall down; but before they fall, they get solidified. \therefore non uniform weld bead is produced. back hand wt is preferred.

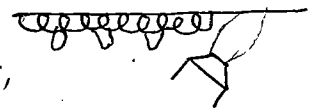

Flux used in gas welding

During gas welding operation; the welder is frequently taking out the filler rod from the welding zone and dipping it in a powder - called as flux powder.

Functions :-

1. To deoxidize the melt.
2. To observe gases present in the weld pool.
3. To form slag layer over weld bead and avoid atmospheric contamination.

Properties :-

1. It should deoxidize the melt.
2. It should absorb gases.
3. It should be able to form slag layer.
4. M.P should be $<$ M.P of parent and filler rod material.
5. ρ should be as low as possible for easy separation from the molten metal.
6. Viscosity should be low for slag produced, for easy spreading.
7. Sulphur should not be present in the flux powder (sulphur is best deoxidant bcz it react with O_2 to form SO_2 which is highly poisonous).

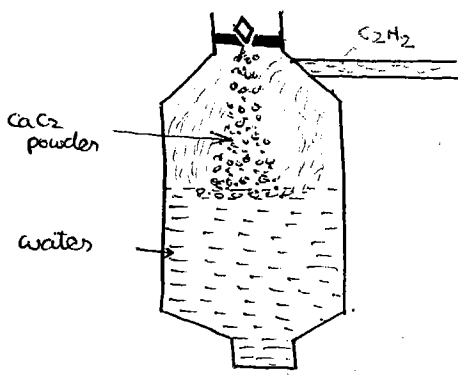

CaC₂ powder is used.

low pressure acetylene is produced

but production rate is high (area of powder exposed chemical reaction is increased)

The equipment is larger bcz; it always needs a rolling mill besides the carbide to water type equipment.

Acetylene is always stored as acetone.

when we add acetylene to acetone; it would absorb the acetylene added and no separate mechanism is needed.

- 1 ltr acetone \Rightarrow 25 ltr of C₂H₂ @ 1 ksc
- \Rightarrow 15 x 25 = 375 ltr of C₂H₂ @ 15 ksc
- \Rightarrow 25 x 25 = 625 ltr of C₂H₂ @ 25 ksc

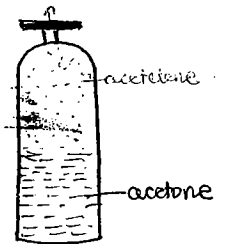

15 ksc is the safe storage pressure of acetone - beyond which acetone may get exploded at any time.

Air Acetylene Gas Welding :-

If whatever the total oxygen required for complete combustion of the acetylene is obtained only from the atmospheric air; it's called as air-acetylene gas welding.

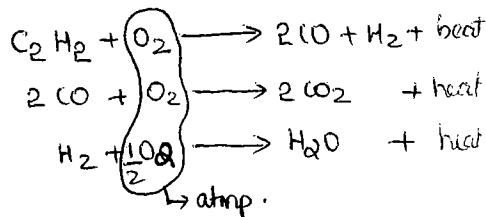

long flame

Here flame is to travel for a longer distance for complete combustion to take the total oxygen from the atmosphere; - the convection and radiation heat energy losses are very high. \therefore the average temp of flame is about 500-700°C.

Bcz of very low average temp of the flame, only very low m.p materials can be joined, like lead, tin, zinc, cadmium etc.

This also can be used as a heat source for soldering operation.

Oxy-Hydrogen Gas Welding

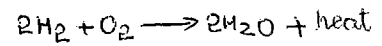
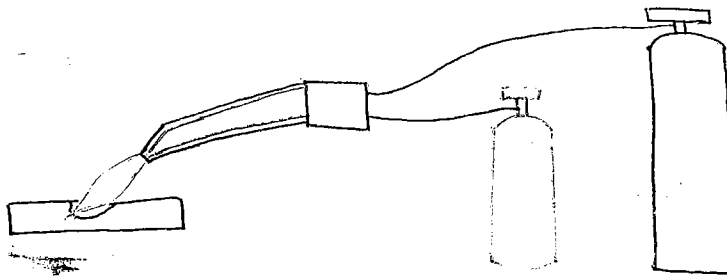

$$\frac{H_2}{O_2} = 2 \text{ (Theoretical)}$$

$$= 2.5 \text{ to } 6$$

Theoretically the ratio of $H_2:O_2$ ratio is 2. But practically, this ratio is 2.5-6 can be used. So that during welding the excess hydrogen present in the flame is simply moving away from the welding torch and acting as a shielding gas for protecting weld pool from atmospheric contamination. \therefore this method can be used for joining of highly reactive metals like aluminium, Mg etc.

Max. Temp in flame = $2880^\circ C$

Average Temp = $700 - 900^\circ C$

This lower avg. temp is due to the formation of water.

Bcz of this low avg temp of flame; this method can be used for joining of low MP materials including aluminium.

This method was developed for joining of highly reactive metals.

ATOMIC HYDROGEN GAS WELDING (Special Gas welding process)

It's also called as special gas welding process bcz; it's a combination of gas and arc welding operations.

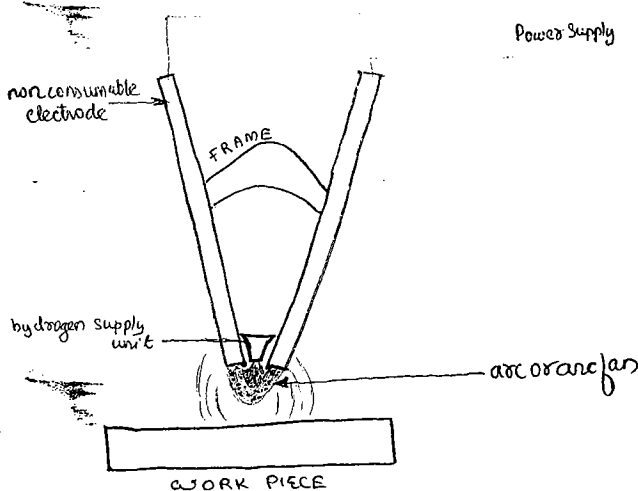

Power Supply

When the power supply is given and optimum gas is maintained b/w electrode tips, the arc is produced ^{b/w} in the electrode tips.

When the hydrogen is supplied into the arc, the molecular hydrogen will be disintegrated into atomic hydrogen which is endothermic reaction, and the heat required for this is obtained from the arc.

The atomic hydrogen produced in the arc for when it comes out becomes an unstable gas at atmospheric condition.

\therefore it's reunited to form the molecular hydrogen which is exothermic reaction. The heat generated with the plates.

examples

1. During gas welding of carbon alloys or nickel alloys - ~~no~~ flux is to be used.
In the presence of carbon or nickel, the material itself act as deoxidizer.
2. Borax - commonly used flux during gas welding of all other metals.

Filler rod :-

It is used to supply additional molten metal to the weld bead.

When ever edge preparation or joint preparation is done for joining of the plates - additional molten metal is required to fill the gap.

If thickness of plates to be joined $t > 5\text{mm}$ - edge preparation is done

If $t < 5\text{mm}$ - square joint can be used
(no - edge preparation)
without supplying any additional metal - Such a welding operation is called Puddling operation
(no filler rods)

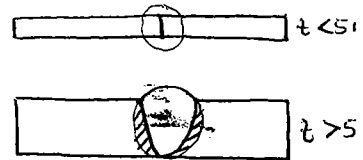

properties to be concerned

1. density (ρ) of filler rod material should be nearly equal to that of parent material so that the mixed molten metal of filler and parent metal would retain sometime without separation.
2. M.P of filler rod material \leq M.P of the parent material.
(to avoid the excess of melting of parent material)
3. The molten metal of filler rod material is readily mixed with the molten metal of parent material.

filler rod materials

Low carbon steel, medium carbon steel, brass etc are commonly used.

Production of Oxygen

Producing O_2 from atm. air is the cheapest & safest methodology

			B.P
air	N_2	78.7%	$-195.8^\circ C$
	O_2	21%	$-183^\circ C$
	Org elements	0.3%	$-185.7^\circ C$

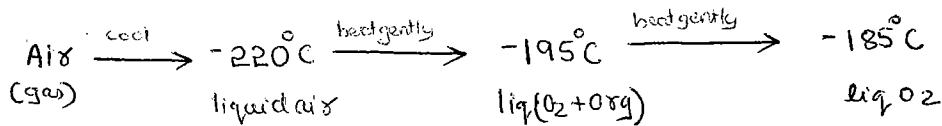

Oxygen is always preferable to store in the form of liquid oxygen only. To avoid the usage of refrigeration system - pressure of liq. O_2 can be increased to 120 KSC. When the B.P of O_2 would be $40-50^\circ C$. Thus this can be stored in the atmospheric temperature easily.

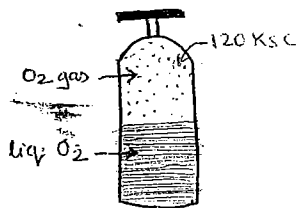

Production of acetylene

C_2H_2 is always produced by mixing calcium carbide with water

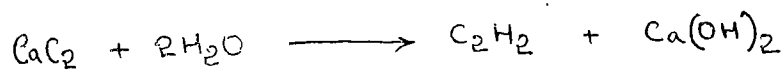

based on this principle 2 method of production is there:-

1) Water to carbide type:

If water is allowed to fall on the Calcium carbide granule for producing the acetylene. ~~is called~~

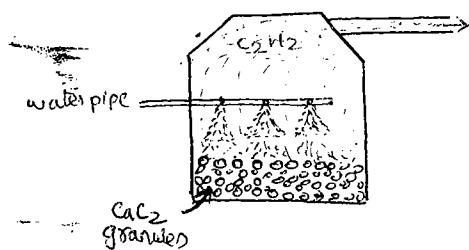

low pressure acetylene is only produced.
Small production rate
It's a portable equipment.

always granule is used instead of powder bcz if we used powder after a top layer reaction - no further reaction occurs.

2) Carbide to water type

In addition - out of the molecular hydrogen produced, nearly $\frac{1}{3}$ rd of the hydrogen is burning by taking the oxygen from the atmosphere and remaining $\frac{2}{3}$ rd hydrogen simply moving away from the welding tool acting as a shielding gas for protecting the weld pool from atmospheric contamination.

The heat req. for melting of plate can be obtained due to exothermic chemical reaction and also by burning of $\frac{1}{3}$ rd of molecular H_2 .

This method gives better protection to weld pool than the oxy-hydrogen weld.

\therefore They are used for joining of highly reactive metals like aluminium, and also used for joining of stainless steel.

Arc Welding:-

The heat required for the melting of the plate is obtained due to electric arc; its called as arc welding.

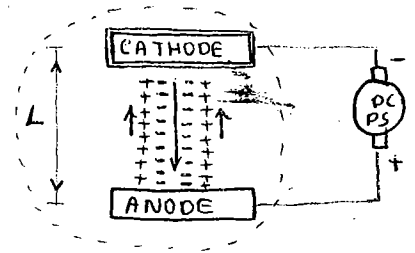
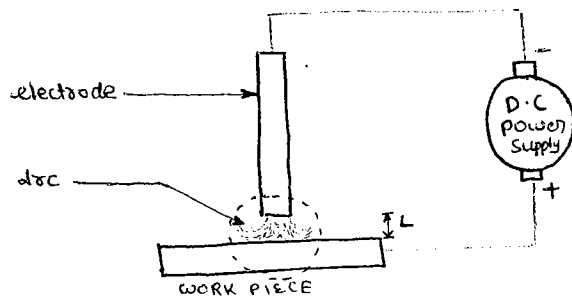

When the power supply is given and optimum gap is maintained b/w tip of electrode and work piece; the high velocity electrons will be generated at the cathode which are attracted by the anode and move towards anode. When they are impinging on to the anode; the K.E of electrons will be converted into heat energy. \therefore the heat is generated at the anode. Simultaneously the high velocity positively charged ions will be generated at the anode which are attracted by the cathode and moves towards cathode. When this high velocity ions are impinging on the cathode; the K.E of the ions is converted into heat energy. \therefore the heat is generated at the cathode also. But the velocity of the electrons is much higher than the velocity of ions. \therefore the heat generated at the anode is higher than that of cathode.

The heat generated at anode to heat generated at cathode = 2:1

During the process some of the $-vly$ charged electrodes and $+vly$ charged ions will collide in the passage. so that the K.E of both the elements will be spontaneously converted into heat energy. which is observed as a spark b/w the

Due to this sparging, the temp. around the arc is around 5000 to 6000°C . From the zone ultra violet rays are generated and spreads around the arc. If the arc is directly seen with human eye, after few minutes of time, the eyes will be started paining. To avoid this the arc must be seen only through safety goggles or safety glasses.

Direct Current Straight Polarity (DCSP) OR Direct Current Electrode Negative (DCEN)	electrode -ve workpiece +ve
Direct Current Reverse Polarity (DCRP) OR Direct Current Electrode Positive (DCEP)	electrode +ve workpiece -ve

AC arc welding OR ACHF (Alternating Current High frequency)

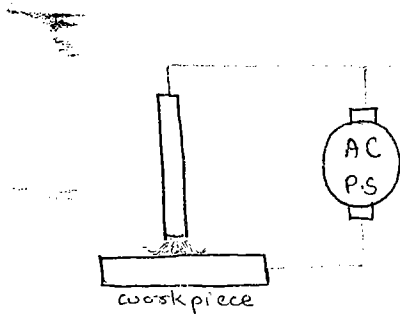

AC power supply is used

50%-50% heat generated at anode and cathode.

If $f = 50\text{ Hz}$, cycle time $T = 0.02\text{ sec}$
each 0.02 sec the polarity changes.

Features of arc welding operations:-

DCSP

Bez of high heat generation at the workpiece; high m.p materials and higher thickness plates could be joined easily.

Higher depth of penetration is also possible.

Bez of lower heat generated at the electrode, the melting rate of electrode is low, deposition rate is low and \therefore only low welding speeds are possible.

DCRP

Bez of lower heat generated at the work piece - only low m.p materials and lower thickness plates can be joined.

low depth of penetration.

Bez of higher heat generation at electrode - melting rate of electrode is high; deposition rate is high and \therefore higher welding speeds are possible.

ACHF :-

Medium thickness plates
medium depth of

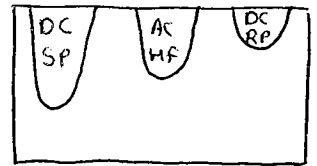

Arc recovery time :-

The time required to establish the arc b/w the electrode and work piece. 'Establishing arc' refers to establishing the flow of electrons and ions in their respective directions.

In D.C arc welding whatever may be the arc recovery time ; it won't influence the welding process.

In AC arc welding bcz the terminals are continuously changing. the arc recovery time must be less than $\frac{1}{2}$ of the cycle time. for effective work of arc.

$$ART < \frac{1}{2} CT$$

In general the C.T will be fixed (since we req. high frequency) and arc recovery time is reduced.

By increasing voltage of power supply the ART could be reduced

for effective welding operation, the range of working voltage used in the arc welding operation is 30-70 V

max. voltage human can withstand.
(considering the risk of danger)

If 50 Hz freq CT = 0.02
If ART = 0.03 sec
No arc could be stru
since polarity changes ev
0.02 s
If ART = 0.018 s
are set up by 0.018 s
thus arc will be sust
only for 0.0002 s
= 2 millise.
So not effective bc
ART < $\frac{1}{2}$ CT

Optimum Settings

For the system to be in equilibrium conditions ; whatever the energy supply by using power supply unit is only ^{has to be} utilized at the arc point. For this it is required to determine the optimum arc length using the welding process and optimum settings of power source.

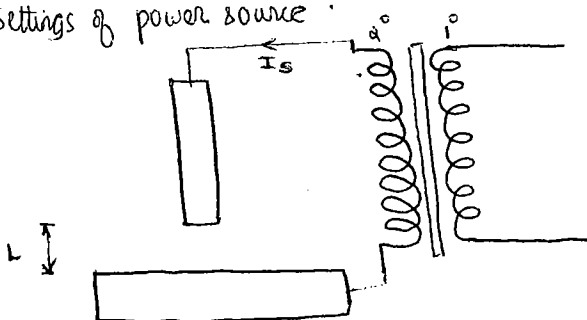

- V₀ - open circuit voltage
- Max Voltage
- I_s - Short Circuited current (max. current)
- I - current passing thru α° when load is connected to a load
- V - Voltage of secondary when load is conn
- L - arc length.

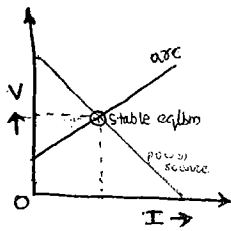

$$V = V_0 - V_{\text{drop}}$$

$$= V_0 - R_s I$$

$$V_p = V_0 - \frac{V_0 I}{I_s}$$

$$R_s = \frac{V_0}{I_s}$$

$$\left. \begin{array}{l} \text{At } L=0, I=I_s \\ L=\text{large}, I=0 \end{array} \right\}$$

as L increases I reduces
 R increases (air gap increases)

$$V = IR$$

Increase of $R \rightarrow$ decrease of I

thus V increases

$$V_a = a + bL$$

At eqbm point.

Voltage at arc = voltage at power source

$$V_0 - \frac{V_0 I}{I_s} = a + bL$$

$$\frac{V_0 I}{I_s} = V_0 - a - bL$$

$$I = \frac{I_s}{V_0} (V_0 - a - bL)$$

$$\text{power} = VI$$

$$P = (a + bL) \frac{I_s}{V_0} (V_0 - a - bL)$$

for optimum arc length

$$\frac{dP}{dL} = 0$$

Q $V_0 = 80V$, $I_s = 2000A$, $V = 20 + 40L$, L -arc length. calculate optimum arc length & setting of a power source

$$V_p = V_a$$

$$V_0 - \frac{V_0 I}{I_s} = a + bL$$

$$80 - \frac{80}{2000} I = 20 + 40L$$

$$\frac{80I}{2000} = 60 - 40L$$

$$4I = 1000(6 - 4L)$$

$$I = 250(6 - 4L)$$

$$\begin{aligned}
 P &= VI \\
 &= (20+40L)(250(6-4L)) \\
 &= 250(20+40L)(6-4L) \\
 &= 250(120 - 80L + 240L - 160L^2) \\
 P &= 250(120 - 160L - 160L^2)
 \end{aligned}$$

$$\frac{dP}{dL} = 0$$

$$0 = 250(-160 - 320L)$$

$$L = \frac{320}{320} \quad L = \frac{160}{320} = \underline{\underline{0.5}}$$

$$\begin{aligned}
 I &= 250(6-4L) \\
 &= 250(6-\frac{4}{2}) = \underline{\underline{1000A}}
 \end{aligned}$$

$$\begin{aligned}
 P &= (20+40L)(250(6-4L)) \\
 &= (20+20)(250)(6-2) \\
 &= 1000 \times 40 \\
 &= \underline{\underline{40, \text{kWatt}}}
 \end{aligned}$$

Q $V=60V$, $I=1000A$. Then the optimal setting for welder is ?

- (A) 60V, 400A (B) 50V, 1000A (C) 60V, 1000A (D) 50V, ~~400A~~

Ans 'D'

Since $V < V_0$
 $I < I_s$

Duty Cycle (%)

The % of time during which the arc is on without overheating of vital eq elements of welding equipments.

$$\text{Duty Cycle} = \frac{\text{Arc 'ON' time}}{\text{Total Welding Time}}$$

ARC ON TIME is the actual welding time during which the arc is on for generating the heat required for melting of the plate.

$$\text{Total welding time} = \text{Arc ON Time} + \text{Rest time}$$

↳ No welding done.

R_s - resistance of the secondary. I the current.

heat generated $\Rightarrow Q_g = I^2 R_s$
(in sec)

here R_s remains constant
but I varies from 0 welds to welding.

heat dissipated $\Rightarrow Q_d = h A \Delta T$ [constant]

$Q_d \geq Q_g$

Rest Time = 0

duty cycle
 $D = 100\%$

$Q_g > Q_d$

$Q_a = Q_g - Q_d$
accumulation

after some time the accumulated heat become very high and temp of transformer becomes very high and the transformer may fail.

To avoid this; after every certain period of time; the rest time must be given to the welding equipment so that during this time only heat dissipation will occur and no-generation of heat.

Q $I = 1500 A$ $Q_g = 10 \text{ kw}$, $Q_d = 6 \text{ kw}$, $(Q_a)_{\text{max}} = 2000 \text{ KJ}$ - Duty cycle?

$Q_a = Q_g - Q_d = 10 - 6$
 $= 4 \text{ kw}$

AOT = $\frac{(Q_a)_{\text{max}}}{(Q_a)} = \frac{2000 \text{ sec}}{4} = 500 \text{ sec}$

RT = $\frac{2000}{6} = 333 \text{ Sec}$

$D = \frac{500}{500 + 333} = 0.6 = 60\%$

Q If same welding equipment with $I = 2000 A$ - Duty cycle.

Thus for every change in I we should calculate the 'D'.

$Q_g \propto I^2$

$D \propto \frac{1}{Q_g}$

so $D \propto \frac{1}{I^2}$

$I^2 D = \text{constant}$

$I_s^2 D_s = \text{const}$

I_s - rated current } obtain from name plate
 D_s - rated Duty cycle }

$$I_s^2 D_s = I_d^2 D_d$$

I_d - desired current
 D_d - desired duty cycle.

$$(1500)^2 \times 60 = 2000^2 D_d$$

$$D_d = \frac{1500^3 \times 60}{2000^3} = \frac{45 \times 3}{4} = \underline{\underline{33\%}}$$

45
 135
 4 1135
 12
 15
 12

if: $I = 1000A = I_d$

$$D_d = \frac{1500^2 \times 60}{1000^2} = 135\%$$

$\rightarrow D_d = \underline{\underline{100\%}}$

So No rest time is there -
 continuous welding can be done.

Electrodes

Functions

- ① Acts as an electrical element for closing the electrical circuit
- ② Sometimes it melts and supplies the additional molten metal to weld bead

If electrode only satisfies the 1st functionality \rightarrow then it's non consumable electrode

If electrode satisfies both the above functionalities \rightarrow then it's consumable electrode.

non consumable electrode

- Should have high M.P and higher electrical conductivity.
- Graphite, tungsten, carbon etc
- C, Graphite - have lower M.P - so used only with DCSP
- Tungsten - have higher M.P - DCSP, DCRP, ACHF.
- Always used as 'base wise' electrodes - NO coatings would be provided on electrode

consumable electrode

- Same qualities as that of filler rod in gas arc welding.
- 2 types :-

① Base wise electrode

② Coated electrode

adv of coating

- 1) Act as deoxidizer during welding
- 2) It can absorb gases present in the molten metal.
- 3) It can form an a slag layer over the weld bead and

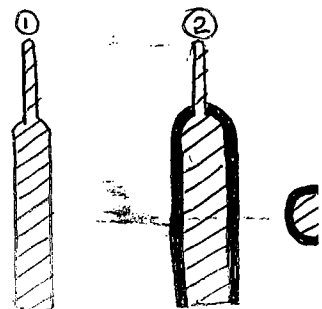

4 It can stabilize the arc

5 It can produce shielding gases for protecting weld pool from atmospheric contamination.

6 It can supply alloying elements for improving the mechanical properties of weld bead.

Type of coatings given

1) For deoxidization and absorbing gases -

Ferrosilicon or ferromanganese coatings

2) For slag formation

Titanium Oxide (Rutile) - TiO_2

3) For Arc stabilization

Potassium compound

4) For shielding gases

Cellulose coatings.

5) For adding alloying elements

Small quantities of Vanadium, cobalt, Nickel, Manganese, Cu, Al etc is added in coatings

Electrode designation

By a 6 digit code

1st 3 digits - indicates performance of coating is w

last 3 digits - indicates mechanical properties of electrode material

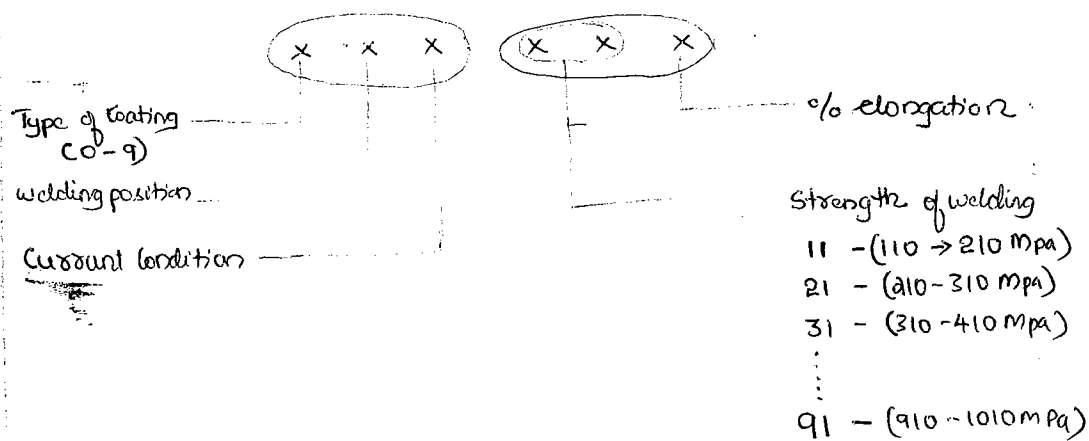

15 CrV₆ steel having 980 MPa is material with highest strength

Titanium also there higher but its not used in welding

Design of weld bead :-

- 1 No of electrodes required
- 2 Welding speed
- 3 No. of passes
- 4 Total welding time

Terminologies

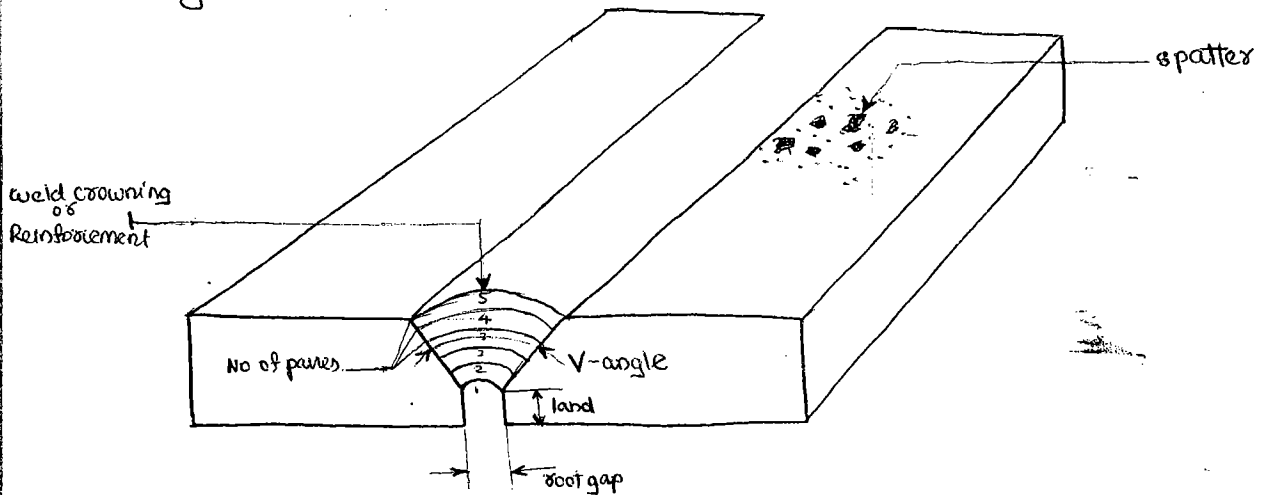

Root Gap:

The gap provided b/w the 2 plates at the bottom most point of weld bead.

If the complete thickness of the plate is not melted at least the molten metal of electrode should flow upto the bottom most point of the plate and produce the joint. So this the root gap is required. Upto 5mm root gap can be given.

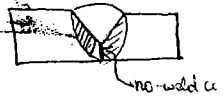

Land

The straight portion of the plates provided at the bottom most part of the plate during welding.

The land is provided to avoid the burning through of edges.

Maximum land used is 5mm.



V-angle

Whenever the thickness of plates to be joined is greater than 5mm; it's necessary to prepare some types of joints like V or U or J joint. Out of which the V joint is the most efficient joint bcz it gives the highest surface area and lower amount of additional molten metal.

Most commonly used V-angles are - 60° or 90° or 120°

No. of passes

Whenever the thickness of plates is higher and higher - it's not possible to join the plate using single pass welding. So it could be done well by using multi pass welding operation.

In most of the welding process, it's always preferable to weld in single pass-welding, it's not use as minimum number of passes as possible to minimize the distortion except in T-joint fillet metal welding operation.

In T-joint fillet metal welding operation, it's not possible to minimize the distortion.

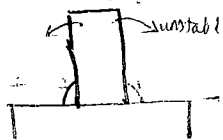

Weld Crowning or Reinforcement

The excess material provided over and above the surface of the plates

Crowning is provided to ensure that the resistance area available at the joint is atleast equal to the resistance area of the plates to be joined.

(Common consideration or assumption in design of welded joints)

10-15% volume of weld bead can be provided as crowning.

Spatter:-

During welding operation, some of the molten metal particles are jumping from the weld pool and fall on other areas of the plate due to the force of arc or flame - called as spatter.

It's the loss of molten metal from the weld pool and affect the surface finish of plates

Spatter loss will be about 5-10% volume of weld bead.

3/11

9am

Design

①

$$\text{No of electrodes required} = \frac{\text{Total Vol. of weld bead}}{\text{Vol. of one electrode}}$$



$$\text{Vol of w.B} = (A_1 + 2A_2) \times L$$

$$\text{Total volume of weld bead} = \text{Vol. of w.B} + \text{Crowning} + \text{Spatter}$$

$$= (1.15 \text{ to } 1.25) \times \text{Vol of w.B}$$

$$\text{Volume of electrode} = \frac{\pi}{4} d^2 l_e$$

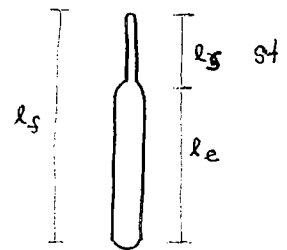

②

heat supplied to weld bead

$$Q = \text{heat utilized for melting} + \text{heat lost by conduction}$$

$$= \frac{5}{4} \pi K \theta_m W \left[\frac{2}{5} + \frac{VW}{4\alpha} \right]$$

K - thermal conductivity of plates

θ_m - m.p of plates to be joined

W - width of the weld bead

V - welding speed

α - thermal diffusivity

During joining of very long plates, the heat transfer by conduction along the length direction is becoming very small and negligible. \therefore the heat transfer along

Then, by considering 2-dimensional heat con. The heat supplied

$$Q = 8 K_0 m^2 \left[\frac{1}{S} + \frac{Uw}{4\alpha} \right]$$

t - thickness of plates

$$\text{welding time/pass} = \frac{\text{length of } w \cdot B}{v}$$

$$\begin{aligned} AOT &= \text{Welding Time (wt)} \\ &= w \cdot T / \text{pass} \times \text{No. of passes} \end{aligned}$$

$$\text{Total welding time} = \frac{AOT}{\text{Duty Cycle}}$$

③ Let α = length of the weldbead welded by using one electrode (obtained from the welding data book; corresponding to the dia. of electrode and thickness of plates to be joined) $\alpha = 200-500 \text{ mm/electrode}$

$$\text{No. of electrodes/pass} = \frac{\text{length of weld bead}}{\alpha}$$

$$\text{No. of passes} = \frac{\text{No. of electrodes req.}}{\text{No. of electrodes/pass}}$$

Magnetic arc blow or Arc blow :-

The magnetic forces created by the electric current will tend to draw the arc in the shortest line of action and making the welding taking place in different plane than required. This is called magnetic arc blow or arc blow.

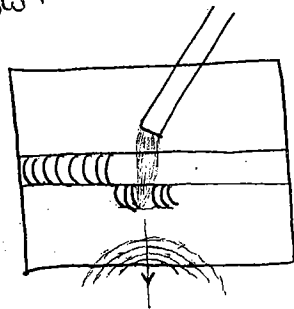

It's mainly occurring in DC arc welding and not in AC arc welding

Reasons

- 1. welding near to the earth connection
- 2. Starting and ending arc blow.

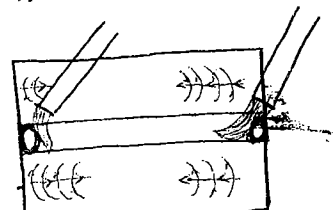

- 3. Simultaneous welding at more than one place which are nearby and using different current condition

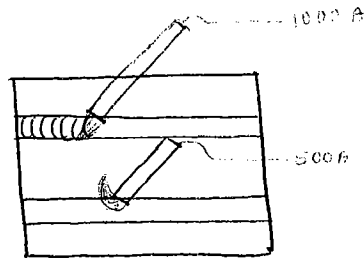

Remedies for magnetic arc blow

1. welding away from the earth connection :-

When the welding is done from one end of the plate, the earth connection would be given on the other end. After half of the welding is been completed, stop the welding and shift the earth connection towards the already weld side.

2. Starting and ending arc blow could be eliminated by using the start on plate & run out plate respectively.

They also get adhered to the plates after weld which could be removed by simple hammer blows.

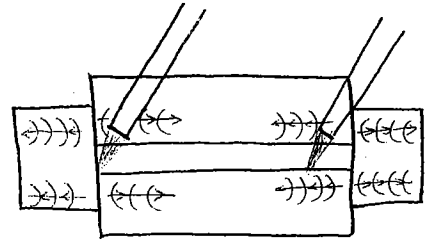

3. Whenever simultaneous welding at more than one place is done, use same current conditions for all the electrodes.

4. The best solution for eliminating the arc blow is using AC power supply instead of DC power supply.

The most commonly used power supply in the arc welding operation is - DC power supply.

But the heat generation of the work piece and electrode can be controlled by changing the polarity.

Tungsten Inert Gas Welding or Gas Tungsten Arc Welding or Argon Arc Welding
(TIG) or (GTAW) or (AAW)

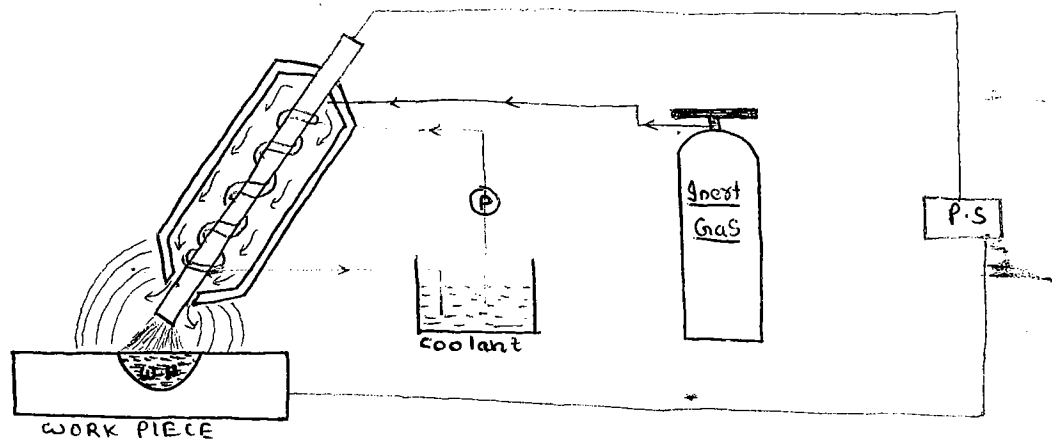

The tungsten is used as an electrode material. \therefore it's considered as a non-consumable electrode welding operation.

To protect the weld pool from atmospheric contamination, the inert gas would be supplied to the welding pool continuously using inert gas cylinders.

The most commonly used inert gas is Argon \therefore name argon arc welding.

To avoid the melting of electrode, the coolant will be supplied through a small pipe which is wrapped around the electrode so that the temp of electrode is kept as low as possible.

Bez of continuous supply of inert gas is taking place in the weld pool; it could be better protected from atmospheric contamination. Hence after the invention of TIG welding; atomic hydrogen became obsolete and TIG is popularly used for joining of highly reactive metals like Al, Mg etc.

Limitations :-

- 1) Cost is very high due to usage of inert gas and coolant.
- 2) Bez of non-consumable electrode welding - only upto 5mm thickness plates can be joined.
- 3) As using the TIG welding operations to join the plates of thickness more than 5mm additional filler rods must be used.
 with filler rods; the air particles may stick to the surface of filler rod and enter into the weld pool; which may contaminate the weld pool again.
- 4) Eventhough tungsten electrode is not melting; at high temperature; the atoms of tungsten may diffuse from the tip of the electrode and enters into the weld pool which increases the brittleness of the weld pool.

Metal Inert Gas Welding

MIG

or

Gas Metal Arc welding

or

GMAW

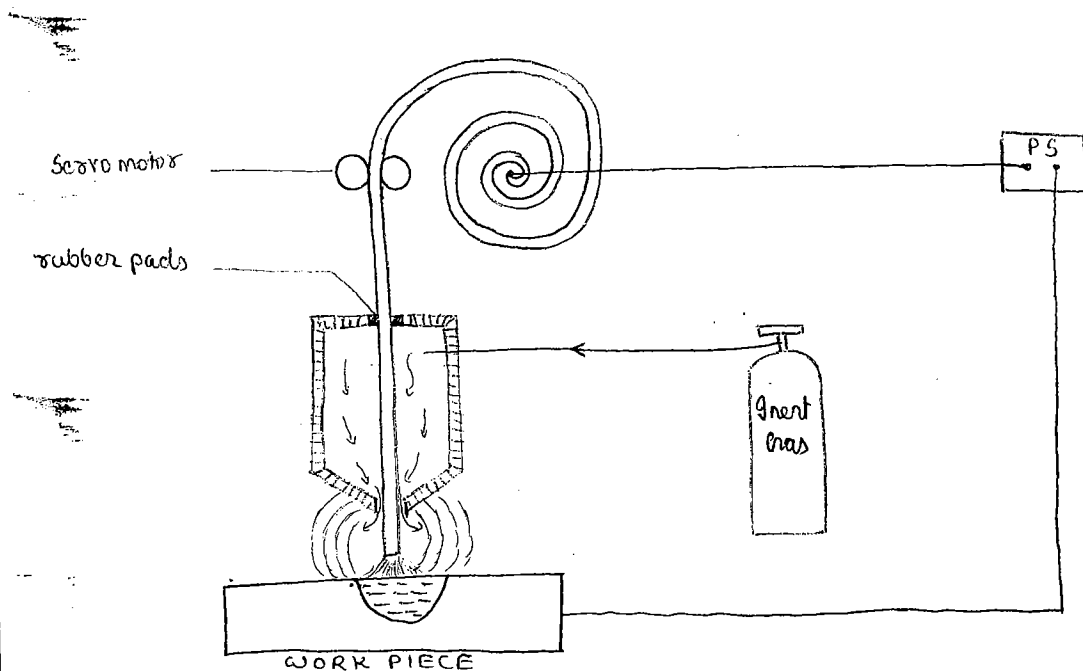

∵ of consumable electrodes; the electrode need not be cooled. ∴
no coolant is to be supplied.

Hence the cost of welding reduces.

∵ Due to consumable electrodes - it's possible to join more than 5mm thickness rods without using any additional filler rods.

When the electrode is passing through the rubber pads, any air particles which are sticking to the surface can be squeezed out.

∵ ∵ electrode itself is consumable, no-tungsten diffusion.

Continuously consumable electrode which is wound on the spool and fed by using servo motor.

Limitation :-

∵ ∵ the electrode is to be wound on to the spool, the maximum size of the electrode would be 3-4mm. During joining of large thickness plates; in single pass welding with mig-welding ∵ of smaller size of electrode; the welding speeds lost must be low.

After low welding speeds; the size of the weld pool produced in front of the arc is very large ∵ due to the force of arc the molten metal particles then easily jump from the weld pool and

∵ the spatter loss would become very high. ∴ to avoid this max-thickness of plate which can be welded by using single pass welding is 30mm only.

Submerged Arc Welding

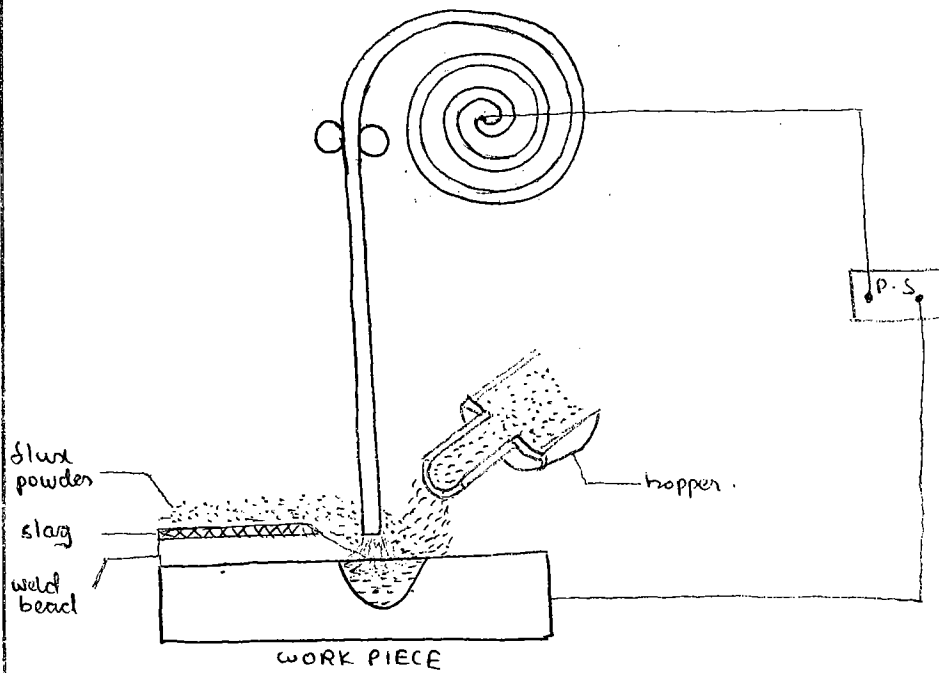

In this the arc is completely submerged in the flux powder. name - Subm arc weld

Continuously consumable electrode wound on the spool and fed by using screw cone

In this instead of inert gas, large quantity of flux powder will be supplied through the hopper, out of which some amount of flux powder is melting and converting into the slag - remaining flux powder is simply floating on the top called unreacted flux. It is collected and re-used through the hopper.

In this also during welding of large thickness plates in single pass welding, because of smaller size of the electrodes, the welding speed used is low. And size of the weld pool produced in front of the arc is larger. Due to the force of arc the molten metal particles are trying to jump from the weld pool. But because of presence of large quantity of flux powder over the weld pool, it is obstructing the jumping of molten metal particles. Hence the spatter loss is minimized.

It's limited to use upto 75mm thickness plates economically using single pass welding or beyond 75mm consumption of flux powder is very high.

Electro slag welding:-

It's a special welding process which can be used for joining plates of above 75mm thickness economically in single pass.

It's only been used in vertical welding position.

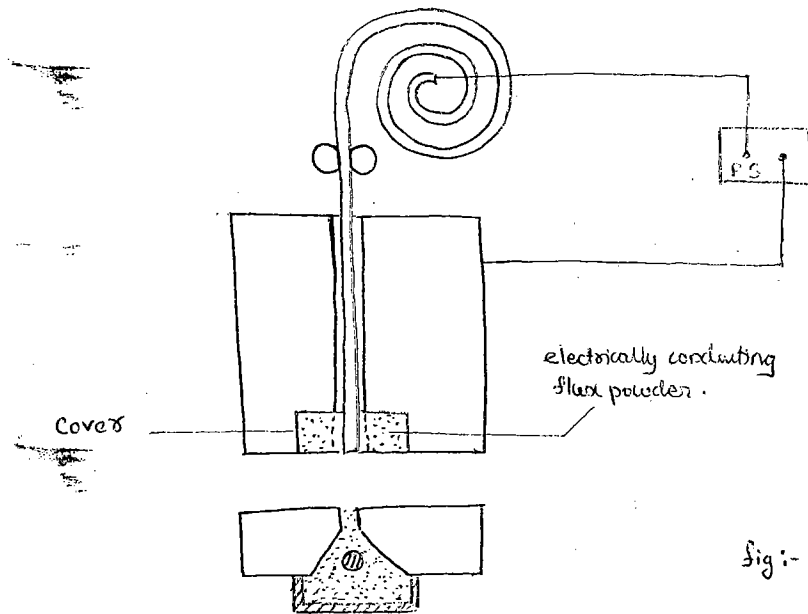

when the power supply is given, the arc is produced b/w the tip of the electrode and work piece; The heat generated due to the arc can be used only for melting of the electrically conducting flux powder and forming as a molten slag; so that the tip of the electrode will be immersed inside the molten slag and the arc is put off.

Now the electricity is flowing from electrode to the work piece; through electrical conductivity of the molten slag.

when the current is passing through the molten slag, bcz of electrical resistance of the slag, the heat is getting generated and this heat will be used for melting of the plates and electrodes. i.e. the heat req. for melting of plates can be is obtained due to the electrical resistance of the molten slag.

name as electro-slag welding operation:

As the electrode is getting melted; it occupies space at the bottom of the weld bead, which pushes the molten slag in the upward direction so that the cover will be moving slowly in the upward direction.

The commonly used electrically conducting flux powder is silicon based flux powder.

any thickness could be welded economically.

but for thickness $< 75\text{mm}$ - it's not much economic.

All the above 3 methods are the pure. Non fusion welding operations.

Soldering Brazing and Braze welding

1 mechanism

In all the non-fusion welding processes; when the liquid molten metal is poured at the joints, it wets the solid surfaces and forms the surface alloy. \therefore the mechanism by which the joint formation taking place is wetting and surface alloying.

Reasons for developing Non-fusion welding

① Whenever two metals are to be joined which has large difference in melting! so that before melting one material; - the other material may be evaporated
eg: steel 1400°C - melts but aluminium evaporates at 950°C

② Some metals can never produce liquid molten metal.

Tungsten (mp - 3400°C - at this temp; W is disintegrated to powder form) even when we heat it to $10,000^{\circ}\text{C}$ we can't form molten tungsten.

③ Whenever a very thin component is to be joined to the very thick components before joining of ~~thick~~ components; thin components will melt.

eg: - joining of electric wires to PCB

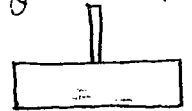

④ Melting and solidification of parent materials causes change in mechanical properties of parent material in fusion welding. In case we are not allowed to change the mechanical properties of parent material: In such cases non-fusion welding will be used.

eg: - IC engine cylinder & fin

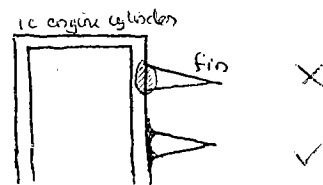

For any non-fusion welding 5 points should be kept in mind

- 1 mechanism
- 2 Temperature
- 3 Heat source
- 4 filling rod
- 5 applications

Soldering

mechanism → wetting and surface alloying

Temperature → $T_{room} < M.P \text{ of plates}$
 $< 427^\circ C$ [since tin & lead alloy will evaporate at $427^\circ C$ (tin present in alloy actually evaporate)]

Heat source → Air-acetylene flame (cold age) of metal A - $350^\circ C$ B - $500^\circ C$ then take $T < 350^\circ C$
 electrical resistance heating (now) of A - $460^\circ C$ B - $620^\circ C$ $T < 427^\circ C$
 which ever is less.

Filler rod → lead-Tin-alloy ⇒ called soft soldering (50 : 50)

lead-Tin-Silver ⇒ called hard soldering - bcz of additional silver. Strength of joint produced is very high. (expensive)
 (30 : 30 : 40)
 ↓
 only used in space application (aircraft, missiles, space shuttle)
 (vibration is high - so it is used)

A small quantity of bismuth is added to filler rod to increase the wettability of molten metal to solid body and to reduce the MP of filler rod materials.

Application → mainly used for joining electric and electronic wires to the PCB
 hard soldering is space applications.

Brazing - if without joint preparation - 2 plates are joined.

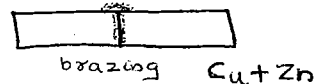

mechanism → wetting and surface alloying

Temperature → $< M.P \text{ of plates}$
 $> 427^\circ C$ [lowest MP of Cu alloy is $420^\circ C$ ~~420~~. So for every case, we take $427^\circ C$]

A - $350^\circ C$ B - $500^\circ C$] X not possible
 A - $460^\circ C$ B - $620^\circ C$] $427 < T < 460^\circ C$

* metals having $M.P < 427^\circ C$ cannot be brazed or braze welded

Heat source → Oxy-hydrogen
 furnace brazing
 resistance brazing

Filler rod → Copper-Zn alloy - having high capillary among copper alloys
 [since molten metal of filler rod are flowing in the joint due to capillary action]

Application - whenever joint preparation are not possible.
closing hole of a pipe.

Braze welding :- if 2 plates joined with end preparation.



All properties are same except the fill.

filler rod \div molten metal from filler rod move in b/w the plates by gravity.
Cu-Tin alloy is having high liquidus line among the Cu alloys.
so it's been used.
Cu won't allow tin to get evaporated even above 427°C (may get doubt)

Application \div whenever joint preparation are possible.
Joining of pipes.

order of priority

Braze welding < brazing < soldering.

27/8/11
9:30-1

In brazing operation as the joint thickness (or) joint gap is increasing the strength of the joint is increases first and then reduces.

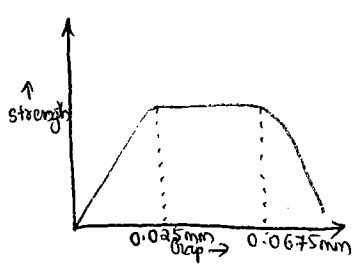
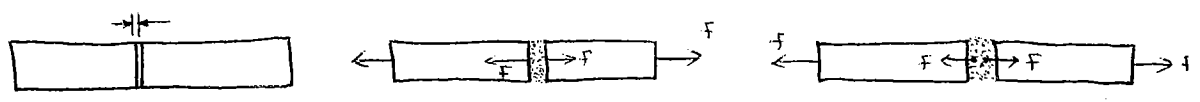

as joint gap increases the flow of molten metal into the joint increases, as the flow become easier.
 \therefore wetting area and the surface allowing area increases.
Hence the joint strength increases.
after some gap the quantity of filler rod materials present the joint becomes considerable. \therefore during usage of the component; the force will be transmitted into the filler rod material also and the filler rod materials fracture before the surface alloy joints fracture.
Hence the strength of the joint reduces.

Resistance welding

Resistance spot welding :-

The heat req. for melting of plates and joining is produced bcz of electrical resistance.

∴ name given as resistance welding.

The shape of this weld bead produced is approximately like a spark.

∴ called as spark welding.

It's a fusion pressure welding process

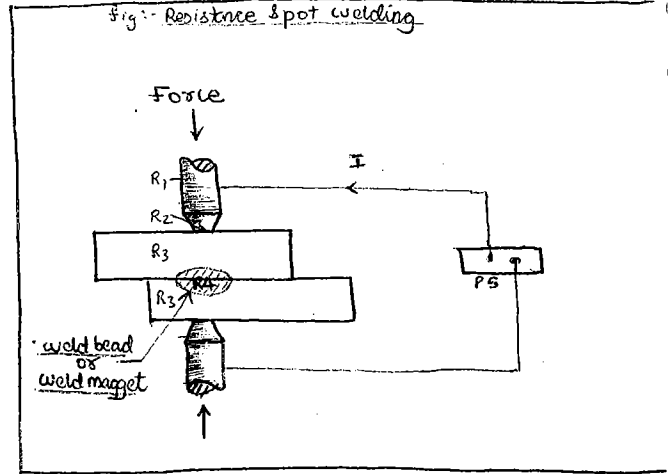

Heat generated (H.G)

$$Q_g = I^2 R T$$

non-consumable electrode material should have

→ low electrical resistance

→ high M.P

→ higher strength

preferable materials for manufacturing of electrodes are

Cu or Tungsten or Cu-Tungsten alloy

Resistance

(R₁) - should be as minimum as possible

(R₂) - contact resistance b/w tip of electrode and work piece.

it also should be as minimum as possible

Generally R₂ depends on

→ surface roughness & cleanliness of surfaces

∴ minimize R₂ - contacting surfaces must be smooth and clean

(R₃) - electrical resistance of plates to be joined

It should also be as minimum as possible to avoid melting of complete thickness of the plates and joining of electrodes to the plates.

R₃ cannot be changed.

(R₄) - facing surface resistance of joining surfaces or contact resistance

At chid to as maximum as possible.

I - current passing thru the circuit
R - resistance of electrode material
T - time for which current flows
R₁ - resistance of electrode material

Current

I = 10000 A
t₁ = 1.5 mm } steel plate
M.P = 1400°C

t₂ = 10 mm I₂ = ? - steel

$$H_g \propto I^2 \times t \Rightarrow \frac{t_1}{t_2} = \frac{I_1^2}{I_2^2}$$

$$I_2 = I_1 \sqrt{\frac{t_2}{t_1}} = 10000 \sqrt{\frac{10}{1.5}} =$$

t₂ = 1.5 mm, → Al plate, I₂ = ?

$$H_g \propto I^2 \times \frac{t}{M.P} \Rightarrow M.P \propto I^2$$

$$I_2 = I_1 \sqrt{\frac{M.P_2}{M.P_1}} = 10000 \sqrt{\frac{660}{1400}} =$$

t₂ = 5 mm → Cu plate I₂ = ?

$$I_2 = I_1 \sqrt{\frac{t_2 M.P_2}{t_1 M.P_1}} = 10000 \sqrt{\frac{5 \times 1100}{1.5 \times 1400}}$$

Limitation :-

1. Highly electrically resistant materials cannot be resistance welded.

by making contact surface clean and rough

$$R = 2(R_1 + R_2 + R_3) + R_4$$

$$= 200 + 500 + 200 + 200 = 1100 \Omega$$

Dr. P. Rana

T - time during which the current is passing through the resistance welds circuit usually $T < 0.2 \text{ sec}$] current is passed only for a short duration.

Bg: maximum temp ~~indicates~~ in resistance welding is $T_{max} = 9000 - 1200^\circ \text{C}$
 If this much temp is been passed for a bit long time it may leads to burning of plates or entire melting of the plates.

The time is been controlled in such small fraction by using AC current with a relay.

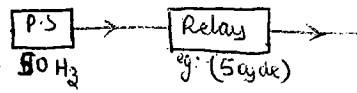

$$T = \frac{5 \text{ cycle}}{50 \text{ Hz}} = \frac{1}{10} = 0.1 \text{ Sec}$$

Whenever the power supply is given, relay will allow only a set number of cycles of power only.

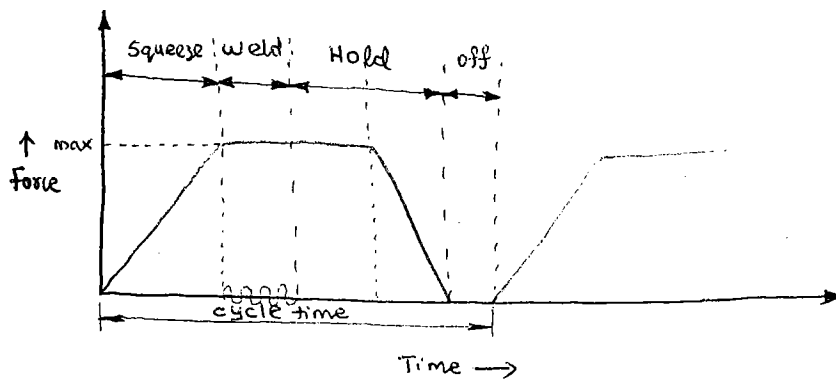

Time during which the air present in the joint would be squeezed out or driven out is called squeeze time.

Time during which the current is passing through the circuit is called weld time (T)

$$H_w = I^2 R (w.T)$$

Time during which the force is continued to hold until the molten metal produces will get solidified is called hold time. (otherwise expansion occurs)

Time during which the complete resistance welding equipment is switched off called off time.

This is to account for

- time taken for shifting of electrodes from present position to the next position
- to account for the rest time in duty cycle.

modification to increase efficiency of resistance weld cycle

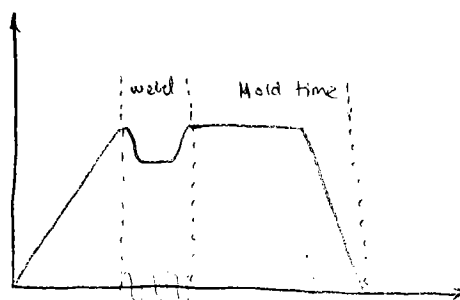

1. During weld time; the force applied on the plates can be reduced slightly so that the roughness of the surfaces will be trying to regain and it increases resistance off which in turn increases the heat generation and size of the weld bead.

2. Just before reducing force in hold time; 1002 cycles of power...

of weld bead, to reduce the brittleness & increase the toughness.

Efficiency of resistance welding

$$\eta_{EU} = \frac{\text{Heat Utilized}}{\text{Heat Supplied}} = \frac{H \cdot U}{H \cdot G_2}$$

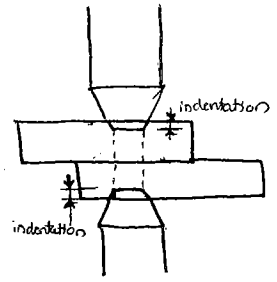

$$\begin{aligned} H G_2 &= m(SH + LH) \\ &= m(C_p(T_m - T_r) + LH) \\ &= 3V [C_p(T_m - T_r) + LH] \end{aligned}$$

actual magnet is elliptical but it's difficult to obtain the dimensions of it. \therefore for theoretical calculation of volume of weld bead - the approx. shape of the weld bead produced is cylindrical with dia equal to dia of the electrode tip and ht is equal to the distance b/w 2 electrode tips.

$$D = 6\sqrt{t}$$

t - avg thickness of plates to be joined.

$$h = 2t - 2(\text{indentation})$$

$$H G_2 = 3 \left(\frac{\pi}{4} D^2 h \right) [C_p(T_m - T_r) + LH]$$

$$\eta_{EU} = \frac{HU}{HG_2}$$

$$= 85-95\% \text{ for resistance welding (highest *)}$$

If $\eta_{EU} = 100\%$ $\Rightarrow HU = HG_2 = m(SH + LH)$

$$I^2 R t = m(SH + LH)$$

$$\eta_{EU} = 45-55\% \quad - \text{Arc welding}$$

$$\eta_{EU} = 55-65\% \quad - \text{Gas welding}$$

methods of improving the strength or load bearing capacity of the resistance welded joint

① To increase the strength; the major axis of elliptical magnet must align with the axis of the joint

The chances of shifting of major axis of elliptical magnet may happen due to the total resistance above the joint is different from below the joint

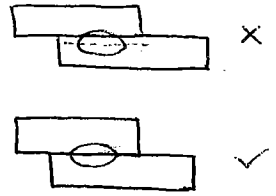

This mainly happens due to the change in R_3 at top and bottom.

Change in R_3 will happen during joining of diff thickness plates of same material or by joining diff material plates of same thickness or different thickness plates used made of different materials.

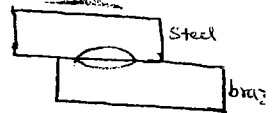

To ensure that the major axis of the elliptical magnet is coinciding with the axis of the joint, the total resistance above the joint must be made equal to total resistance of the joint below.

This is possible by changing the electrode material or by changing the dimensions of the electrode.

If higher resistance is needed on any side use Tungsten. (if the magnet product is low)

If lower resistance is needed on any side use Cu (if weld bead is very large)

Mainly the diameter of the electrode is been changed (not the length)

$$R = \frac{\rho L}{A}$$

② By increasing the overlap of the plates, many number of magnets will be produced in the plates.

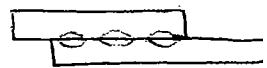

When producing multiple magnets; during making of 2nd and subsequent magnets; the shunting or bypassing of electricity may take place. The shunting is the property of electricity that which always try to pass through the continuous material rather than discontinuous material; if it's available nearby

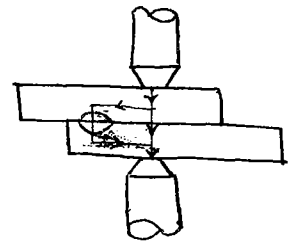

Shunting can be eliminated by maintaining optimum spot spacing.

minimum spot space to avoid shunting is $\geq 4.8 \tau$



③ By using continuous resistance welding or resistance seam welding.

Resistance Seam Welding

The continuous resistance welding b/w the two plates to be joined

disc shaped electrodes are used

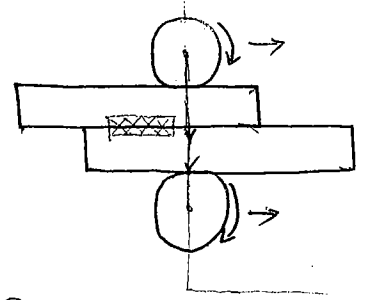

The problem of shunting of electricity is very severe and it cannot be eliminated.

\therefore To get the req. amt. of current at joint whatever the amount of current which is bypassing, the corresponding amount of current has to be increased at the supply conditions itself.

Resistance Projection Welding Operation :-

The method of joining a projected component of ~~or~~ by using resistance spot welding operation is called the resistance projection welding.

The shape of the electrode will be same as the shape of the component to be joined.

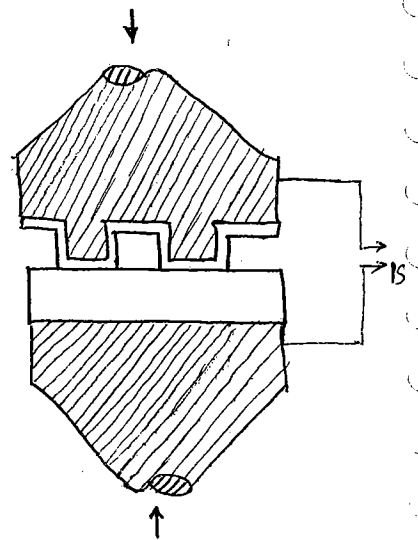

Percussion Welding Operation

This is a non-fusion pressure welding

end-to-end joining is done - so butt joints are produced

No separate electrodes are used - the components to be joined acts as electrode

In this the power supply will be given first so that the joint can be heated to a temperature nearly equal to the M.P temp. of the material. So that the material of the joint will become

Very soft and atoms present in the surfaces will more active to share the energy.

Now stop the power supply and apply the force percussively (suddenly).

Thus a surface alloy joint would be forming b/w materials

It gives lower joint strength and are used for joining of shafts from end to end

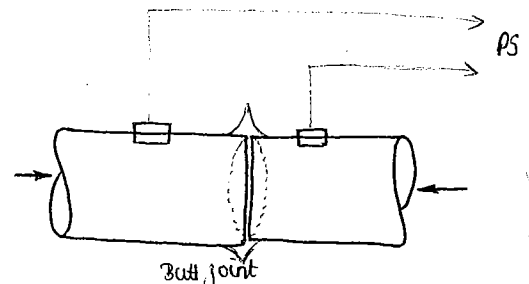

During the process some amount of material projects from the joint as a flash.

\therefore it is also called as Flash butt welding.

Common application of Resistance welding

① Where ever leak proof joints is to be produced

eg:- pressure vessels, fuel tanks of automobiles.

② Where ever the increase in weight of the system is not allowed.

eg:- aircraft construction, manufacturing of structural tubes of a cycle, space craft.

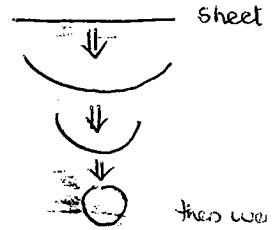
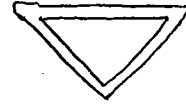

③ Joining of throw away type of tip of tools to the tool bodies.

Thermit welding

Thermit mixture $\xrightarrow{\text{chem. reaction}}$ **heat** + residues

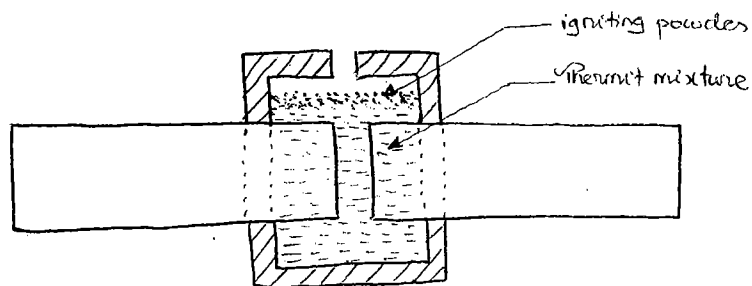
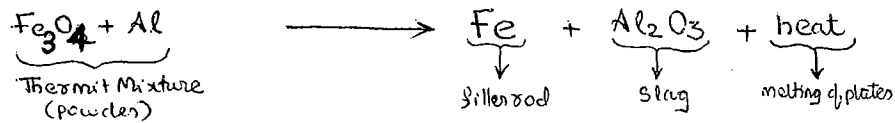

$$T_{\text{max}} = 3750 - 4000^\circ\text{C}$$

The initiation for burning of igniting powder will be given by using a ~~box~~ match box.

The most commonly used igniting powders are barium peroxide or Magnesium

When igniting powder is burned; the heat generated will be used for initiating the exothermic chemical reaction of thermit mixture and produce iron, Al_2O_3 and heat.

Mainly developed for joining of rails in remote areas like hilly, forest areas etc where electricity is not available for joining.

also be used for joining of thick components.

Pre heating

Heating the joint before welding

→ It remove the dirtiness present in plates like for evaporating grease, oil, H₂O etc

→ Whenever high thermal conductivity and high M.P materials are to be joined.

Bcz - during welding of such materials, the heat lost by conduction is very high ∴ it's too difficult to raise the plate to Melting Point.

By doing the preheating - the heat lost by conduction can be reduced (by maintaining less temp difference)

→ During joining of high expansion materials - when the plates are preheated, the weld bead will be cooled slowly and cracking tendency can be eliminated.

→ During joining of ring like structures; the ring should be preheated at a place exactly opposite to that of the weld bead so that the cracking tendency of the ring will be eliminated

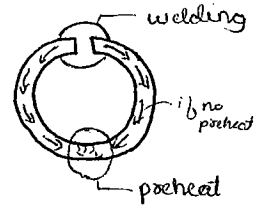

→ Whenever the welding speed is to be increased. Instead of raising the temp from room temp; only from an intermediate temp.

Post heating :-

Heating the weld bead after the welding

→ To relieve internal residual stresses present in the weld bead

→ To reduce the brittleness and increase the toughness of weld bead

→ To convert martensite structure present in weld bead into troostite or sorbite

Weldability

The ease with which the welding of given metal can be done without producing defects in the weld bead.

Factors :-

① M.P of the metals to be joined

Both very high MP and Very low M.P materials are taken as a difficult weld materials

Medium MP materials are taken as 'easy to weld' materials.

② Thermal conductivity of metals to be joined

High thermal conductivity materials are taken as difficult to weld materials
Bcz - the heat lost by conduction is very high and it is difficult to raise the plates to M.P.

If a material is having high MP and high thermal conductivity it is treated as difficult to weld - but could be welded by pre-heating

③ Coefficient of thermal expansion of materials

High expansion materials are taken as difficult to weld material
bcz. it produces crack very early in the weld bead

④ Reactivity of the metal

Highly reactive metals - very difficult to weld. eg:- Al, Mg

⑤ Electrical resistance

highly electrically resistance materials - very difficult to resistance w

⑥ Surface condition

Dirty surfaces are difficult to weld

Q write Cu Al MS CI in decreasing order of its weldability

MS \rightarrow Cu \rightarrow CI \rightarrow Al

29/8/11

Q-9am

Defects in welding

- 1 External defects (seen from outside)
- 2 Internal defects

1

- 1 Over lap
- 2 Under cut
- 3 Spatter
- 4 Crater
- 5 Excessive convexity
- 6 Excessive concavity
- 7 Surface porosity
- 8 Surface cracks

2

1. Internal porosity
2. Internal cracks
3. Slag inclusion
4. Incompletely filled groove
5. Lack of fusion

① Overlap

If the excess of metal is provided at one side or both the sides of weld bead.

Reasons

magnetic arc blow with DC RP

Manipulation of torch movement in gas welding

Excessive current condition

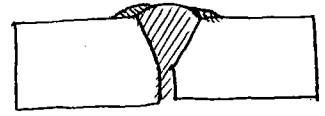

② Under cut

Reasons

Use of DCSP with magnetic arc blow

Excessive arc length \Rightarrow force of arc is high

Insufficient size of the electrode

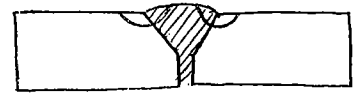

③ Spatter

During welding due to force of arc or flame, some of the molten metal particles are jumping from the weld pool and falling on the other areas of plate.

Reasons

Lower welding speed if used for welding large thickness plate.

Excessive arc length

Magnetic arc blow

Manipulation of the torch movement.

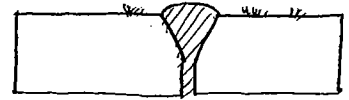

④ Crater

Shallow spherical depression produced at the end of the welding

Reasons

Increased torch angle or electrode angle at the end of the welding

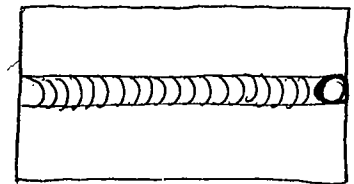

⑤ Excessive convexity

Reasons

Lower welding speed with DCRT

Excessive size of the electrode

Excessive current conditions



⑥ Excessive concavity

Reasons

Use of DCSP with high welding speed

Insufficient size of the electrode

Insufficient or incorrect current conditions



① Internal porosity

Small size air particles or gas particles present on the surface of weld bead is called surface porosity and if it is present at the inside it is called internal porosity.

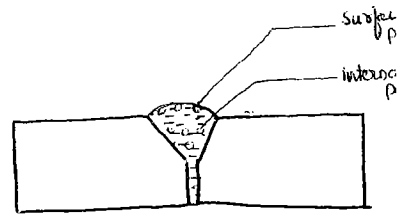

Reasons

- Gas welding without the use of flux
- Arc welding with the use of bare wire electrodes
- Use of damp electrodes (excessive cellulose coated electrode)
- Use of shielding gases during welding.

⊗ No blow holes would be produced in welding.

② Internal Cracks

If cracks are present on the surface of the weld bead it's called surface crack and if found inside; it's called internal cracks.

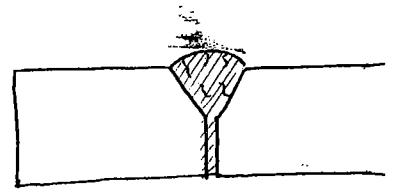

Reasons

Presence of residual stresses in the weld bead by arresting the distortion taking place in the joining plates.

Joining of high expansion materials without preheating.

Use of hydrogen as a shielding gas during welding of ferrous materials (absorb H_2 and become brittle).

Allowing the tungsten diffusion in TIG welding.

③ Slag inclusions

The presence of slag particles inside the weld bead.

Reasons

Use of forehand welding technique in gas welding.

Incorrect selection of fluxes in gas welding or flux coatings (flux is near to parent material) in the arc welding.

Improper cleaning of the weld bead in multipass welding.
Excessive use of flux in welding.

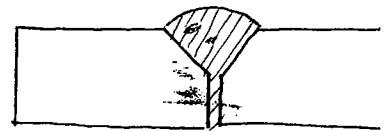

④ Incompletely filled pool

Reasons

Joining of high thermal conductivity high M.P materials without preheating.

Joining of dirty surfaces without preheating.

Welding of high M.P and higher thickness plates using small torch angle.

Joining of high M.P materials or higher thickness plates using d.c.r.p.

Lower amount of the root cap.

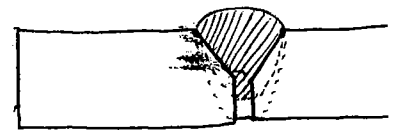

⑤ Lack of fusion :-

No melting of parent material is taking place.

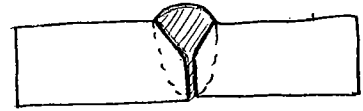

Reasons are same as incompletely filled pool

Welding Classroom Booklet (chapter 2)

1 $P = 0.4 + 0.8L - 0.1L^2$, $\eta_{m} = 20\%$, $\rho = 8 \text{ g/cc}$, Heat req. = 1400 J per g, $l = 1000$, $t = 5 \text{ mm}$

No. k given; - so:
 Speed velocity $\Rightarrow V = \frac{\text{Length}}{\text{Area} \times \text{Time}} =$

$\frac{dP}{dL} = 0.8 - 0.2L = 0$

$L = 4 \text{ mm}$

$P = 4 + 0.8 \times 4 - 0.1 \times 4^2$
 $= 5.6 \text{ kW}$

Welding speed = $\frac{l}{AOT}$
 $= \frac{l \times \text{heat supp} \times \eta}{\text{Heat req}}$

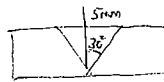

Heat req. = $\text{mass} \times \rho \times H \cdot R / g$
 $= (A \times l \times \rho) \times 1400$
 $= (2 \times \frac{1}{2} \times 5 \times 30 \times 5) \times 1000 \times 10^{-3} \times 1400$

$AOT = \frac{\text{Heat req.}}{\text{heat supplied} \times \eta}$
 $= \frac{HR}{P \times 0.8}$

2 $V_a = 20 + 40L$

$V_p = V_0 - \frac{V_0}{I_0} I$

$V_a = V_p$

when $L = 3 \text{ mm} \Rightarrow I = 500 \text{ A}$ (he has not given respectively so for len and for hgt and)

$V_a = 20 + 40 \times 0.3 = 32 = V_0 - \frac{V_0}{I_0} \times 500$

when $L = 5 \text{ mm} \Rightarrow I = 400 \text{ A}$

$V_a = 20 + 40 \times 0.5 = 40 = V_0 - \frac{V_0}{I_0} \times 400$

$V_0 = 72 \text{ V}$

$I_0 = \frac{V_0 \times 100}{8} = 900 \text{ A}$

③ $H \cdot R = I^2 R t$

$$= (10000)^2 \times 200 \times 10^{-6} \times \frac{5}{50} =$$

④

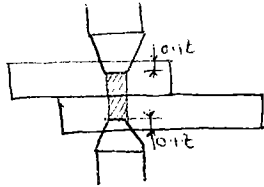

$$H \cdot R = \text{max} \times HR \frac{1}{2}$$

$$= \left(\frac{\pi D^2}{4} \times h \right) R \times 1380$$

$$0 = 6 \sqrt{R} = 6 \sqrt{5}$$

$$h = 2K - 2 \times \text{rod dia}$$

$$= 2K - 2 \times 0.17 = 1.82$$

⑤

$$P_g = 50 \text{ KVA} \quad V_g = 25 \text{ V}$$

$$\text{so } I_g = \frac{P_g}{V_g} = \frac{50 \times 10^3}{25} = 2000 \text{ A}$$

$$D_g = 50\%$$

$$I_d = 1500 \text{ A}$$

$$D_d = \frac{I_g^2 D_g}{I_d^2} =$$

$$D_d = \frac{AOT}{TWT}$$

$$AOT = Q \times T \cdot W \cdot T$$

⑥

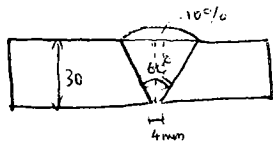

$$\text{No of electrodes} = \frac{\text{Total vol of weld bead}}{\text{Volume of electrode}}$$

$$= 1.1 \times \frac{[(30 \times \tan 30) \times 30 \times 2] + 4 \times 30}{\pi \times 1000}$$

$$= \frac{[\frac{\pi}{4} \times 4^2 \times (450 - 50)]}{\pi \times 1000}$$

$$= 140$$

⑦

$$\lambda = 200$$

$$\text{No of electrode/pan} = \frac{1000}{200} = 5 \text{ electrode}$$

$$\text{No of panes} = \frac{140}{5} = 28 \text{ panes}$$

⑧

$$AOT/\text{pan} = \frac{1000}{100} = 10 \text{ min}$$

$$AOT = 28 \times 10 = 28 \text{ min}$$

$$TWT = \frac{AOT}{DC} = \frac{280}{0.6} = 467.67 \text{ min}$$

⑨

$$H \cdot I = I^2 R t$$

$$= (150)^2 \times 30 \times 10^{-6} \times \frac{900 \times 60 \times 0.8}{300}$$

⑩

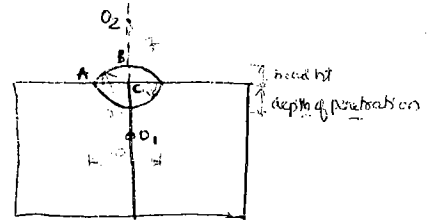

$$\text{Beckht} = BC = O_1C - O_1B$$

$$= 20 - \sqrt{O_1A^2 - A_1D^2}$$

$$= 20 - \sqrt{20^2 - 5^2} =$$

$$\text{Depth} = BD = O_2D - O_2B$$

$$= 7 - \sqrt{O_2A^2 - AB^2}$$

$$= 7 - \sqrt{7^2 - 5^2}$$

⑪

$$G_{g1} = I^2 R$$

$$= \frac{V^2}{R} = \frac{V^2}{R_c}$$

$$R_{c1} = 0.25 \times \frac{L}{\pi \times \lambda}$$

$$= \frac{0.25 \times 2 \times 10^5}{25 \times \pi \times 0.02}$$

$$G_{g1} = \frac{V^2}{R_{c1}} = \frac{5^2}{R_{c1}} =$$

$$G_{g2} = \frac{V^2}{R_{c2}}$$

⑫

$$H \cdot S = H \cdot U$$

$$0.5 = m (SH + LH)$$

$$= \text{Vol} \times \rho [(T_m - T_0) + L]$$

$$0.5 = \alpha \times h \times \rho [(896(433 - 303) + 378 \times 10^3)]$$

$$h = 3.55 \text{ mm}$$

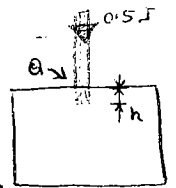

⑬

C

⑭

$$HI = \frac{V I \eta}{\text{Speed}}$$

$$= \frac{25 \times 200 \times 0.65}{\frac{18}{60}} = 10.83$$

(15) filling area = filled rate

$$\frac{\pi}{4} d^2 \times f = A \times \text{Speed}$$

$$\frac{\pi}{4} \times A = \frac{\pi}{4} \times \frac{1.2^2 \times 4000}{180} = 25$$

(16)

$$H \cdot S = H \cdot U$$

$$I^2 R T = m \cdot H \cdot R / \text{kg}$$

$$= \text{Vol} \cdot \rho \times 1400$$

$$= \frac{\pi}{4} \times 5^2 \times 1.5 \times 10^{-9} \times 8000 \times 1400 \times 10^3$$

$$I = \sqrt{\frac{C}{200 \times 10^4 \times 0.1}} =$$

(17)

$$HI = Q_g = VI = 150 \times 30$$

$$H \cdot R \text{ for melting of electrode} = \frac{\pi}{4} d^2 f \rho [C_p (T_m - T_s)]$$

$$\eta = \frac{H \cdot R}{Q_g \times 2/3} =$$

(18)

$$(19) R = \frac{H \cdot R}{Hg}$$

$$\begin{cases} HR = \text{Vol} \times \rho \times 2.9 \\ HR = I^2 R T \\ = 6000 \times 7.5 \times 10^{-6} \times 1.5 \end{cases}$$

$$(20) V_0 = 80 \quad I_2 = 800, \quad I_1 = 500, \\ L_1 = 5 \quad I_2 = 400 \quad L_2 = 7$$

$$V_a = V_p$$

$$V_a = E = a + bL$$

$$V_p = V_0 - \frac{V_0}{I_s} I$$

$$V_a = V_p$$

$$a + b \times 5 = 80 - \frac{80}{800} \times 500$$

$$a + b \times 7 = 80 - \frac{80}{800} \times 460$$

$$a =$$

$$b =$$

(21) C

$$(22) 3V + I = 240$$

At optimum condition

$$V_a = V_p \quad ; \quad I_a = I_p$$

$$I = 240 - 3V$$

$$P = VI = V(240 - 3V)$$

$$= 240V - 3V^2$$

for optimum power

$$\frac{dP}{dV} = 0 \quad ; \quad 240 - 6V = 0$$

$$V = \frac{240}{6} = \underline{40V}$$

(23) Ans: 27 (not given to choice)

(24) 344 (c)

(25)

$$H \cdot G = I^2 R T \\ = 360$$

$$H \cdot D = HG - HR \\ \geq 360 - 344 \\ = \underline{16}$$

(26)

$$H \cdot R = \text{Vol} \times H \cdot R / m^3$$

$$= \frac{\pi}{4} (D_0^2 - a^2) \times 1 \times 2 \times 64 \cdot 4 \times 10^8 \times 10^{-9}$$

$$H \cdot S = P = VI = \frac{V^2}{R}$$

$$\frac{H \cdot R}{H \cdot S} =$$

(27)

B

(28)

B

(29)

$$Q_g \propto I^2$$

$$\propto t$$

$$t \propto I^2$$

$$I_2 = I_1 \sqrt{\frac{K_2}{K_1}} = 100 \sqrt{\frac{5}{10}}$$

(30)

(31)

B

(32)

A

(33)

$$F = P \times A \times U$$

$$T = F \times \frac{2}{3} \times R$$

$$P = \frac{2TTR}{60 \times 1000}$$

(34)

A true R false

c

(35)

'B'

METAL CUTTING

Ref: Metal Cutting by Redford and Booth Royd

Metal Cutting by Sen and Battacharya

Metal cutting tool by Nagpal

Experimental investigation in metal cutting by VC Venkatesh

Metal cutting is a process of analysing machining or metal removal process for determining the forces in machining operation, power consumption in machining operation, the temp. induced in machining operation, tool life etc.

Hot hardness temperature: the minimum temp. above which increase in temperature causes considerable reduction in the hardness of a tool material.

H-C steel tool

Temp	hardness
30°C	Rc 65
100°C	Rc 64
200°C	Rc 63
hot hardness temp of high carbon steel → 250°C	Rc 62
260°C	Rc 61

By knowing the forces in machining the rigidity requirement of the machine tool can be estimated. By knowing the power consumption in machining, the capacity of the prime mover required can be estimated. By knowing the temperatures induced during machining, cutting tool material is selected, such that the hot hardness temp of metal > the temp induced during machining.

By knowing the tool life, the process parameters can be adjusted so that the tool life \geq tool changing time.

TYPES OF TOOLS

The machining operation is generally done by using 2 types of tool

① Single point cutting tool

If only one cutting edge is available for removing materials from the workpiece

eg:- Turning tools, shaping tools, facing tools, chisels etc

In general, material removal rate with single point cutting tools is lower.

② Multi Point cutting tool :-

If more than one cutting edge is available for removing the material from the workpiece

eg:- Drill bits, Milling cutters, broaching tools, grinding wheels etc.

Factors influencing Machining Operation [broadly]

① Properties of work piece materials: -

when hardness $\uparrow \rightarrow$ forces increases \rightarrow Power consp \uparrow — tool life \downarrow

② Tool Geometry

③ Use of cutting fluids or coolants

④ Process parameters — interaction b/w tool & workpiece (speed, feed, depth of cut)

Tool Geometry

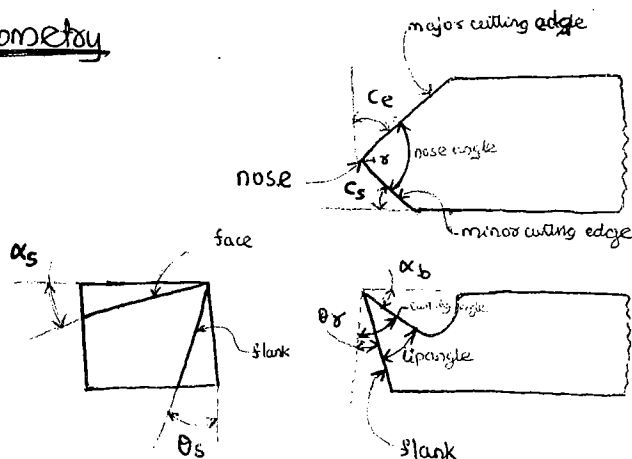

- α_b - Back rake
- α_s - Side rake
- θ_e - End relief
- θ_s - Side relief
- C_e - End Cutting Edge angle
- C_s - Side Cutting Edge angle
- δ - Nose radius

standard method of specifying geometric properties of a single point cutting tool or a tool itself is known as tool designation or tool signature.

① ASA System (American Standards Association system)

$$\alpha_b - \alpha_s - \theta_e - \theta_s - C_e - C_s - r$$

whatever 6 angles indicated in the ASA system are measured w.r.t to 3 mutually \perp planes.

Bez of this understanding of angles of ASA system is easier and measurement of angles also will be easier.

In the machining operation; the formation of chip, formation of shear plane and chip flow behaviour are mainly taking place w. reference to the major cutting edge of the tool. \therefore If different properties of a single point cutting tool are known with reference to the cutting edge; the analysis of machining operation would be easier. but in ASA system the analysis of machining operation is difficult.

② ORS system (Orthogonal Rake System)

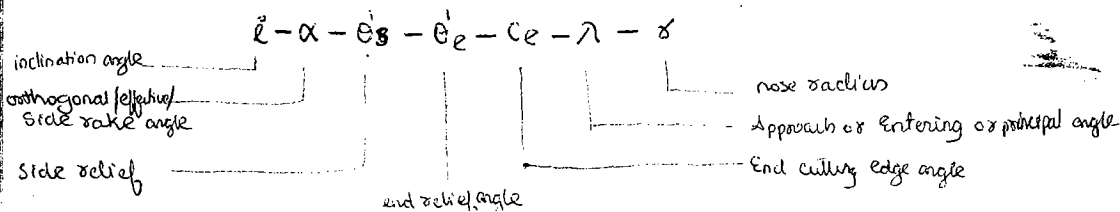

Other angles specified in ORS were measured w.r.t cutting edge of the tool.

∴ Bcz of this it's very easy to analyse the machining operation.

But the understanding of angles and measurement of the angles is very difficult.

→ The most commonly used method of designation of single point cutting tool is ASA system.

→ If nothing is mentioned in the problem, the given designation is always assumed as a ASA system of designation.

A given tool can be designated by using both of the methods. ∴ there must be a relationship b/w the angles of ASA and ORS.

Relationship

$$\begin{bmatrix} \tan i \\ \tan \alpha \end{bmatrix} = \begin{bmatrix} \sin \lambda & -\cos \lambda \\ \cos \lambda & \sin \lambda \end{bmatrix} \begin{bmatrix} \tan \alpha_b \\ \tan \alpha_s \end{bmatrix}$$

|||ly

$$\begin{bmatrix} \tan \alpha_b \\ \tan \alpha_s \end{bmatrix} = \begin{bmatrix} \sin \lambda & \cos \lambda \\ -\cos \lambda & \sin \lambda \end{bmatrix} \begin{bmatrix} \tan i \\ \tan \alpha \end{bmatrix}$$

$$\begin{bmatrix} \cot \theta_s \\ \cot \theta_e \end{bmatrix} = \begin{bmatrix} \sin \lambda & -\cos \lambda \\ \cos \lambda & \sin \lambda \end{bmatrix} \begin{bmatrix} \cot \theta'_s \\ \cot \theta'_e \end{bmatrix}$$

|||ly

$$\begin{bmatrix} \cot \theta'_s \\ \cot \theta'_e \end{bmatrix} = \begin{bmatrix} \sin \lambda & \cos \lambda \\ -\cos \lambda & \sin \lambda \end{bmatrix} \begin{bmatrix} \cot \theta_s \\ \cot \theta_e \end{bmatrix}$$

$C_e \Rightarrow$ remains same

$$C_s = 90 - \lambda$$

$$\lambda = 90 - C_s$$

$\gamma \Rightarrow$ remains same

③ Normal rake system (NRS)

Used before the invention of ASA and ORS.

Only 2 parameters are used.

α_n = normal rake angle.

θ_n = normal relief angle.

ORS to NRS

$$\alpha_n = \tan^{-1} (\tan \alpha \cos i)$$

$$\alpha_b (=ASA) = \alpha (ORS) = \alpha_b (NRS)$$

$$\theta_n = \tan^{-1} \left(\frac{\tan \theta'_s}{\cos i} \right)$$

Effect of Tool Geometry

① Back rake angle (α_b)

- When back rake angle increases \uparrow
 Resisting area available for resisting load decreases \downarrow
 Strength \downarrow
 Force required for machining \downarrow
 Power consumption \downarrow
 Friction \downarrow
 Tool wear \downarrow

* Tool life \uparrow - If tool fails due to lack of strength; it's considered as abnormal failure and it's not considered in tool life calculation.

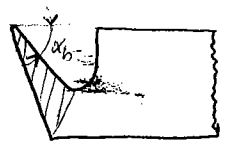
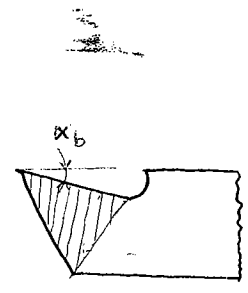

+ve back rake angle

+ve back rake angle

Most commonly used rake angle in the machining operation because the chip flow in the rake face would be easier.
 The max. possible +ve back rake angle used is 45° because beyond 45° , the reduction in the strength of the tool is very high. \therefore the tool will fail easily.



'0' back rake angle

'0' rake angle

- Used during \rightarrow machining of brass work pieces
- \rightarrow Broad cutting operation.

During machining of brass with '0' rake angle, the surface finish produced is better due to the crystallographic structure of brass.

To avoid the weakening of threads during thread cutting operation, the '0' rake angle must be used. So that no-side and flow of the chip be taking place.

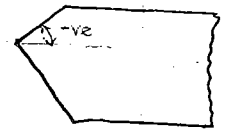

'-ve' back rake angle

-ve back rake angle

The usage of -ve rake angles has been started with the introduction of carbide tipped tool - because the carbide tools are very weak in tension.

-ve rake angle is nothing but the rake angle is reducing due to this

- forces \uparrow Power consumption \uparrow Tool life \downarrow

Hence maximum -ve rake angle used is only upto 10° only.

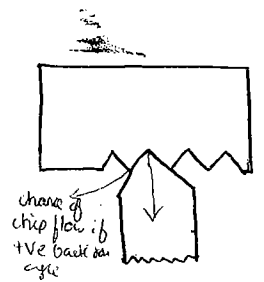

change of chip flow if +ve back rake angle

② Side rake angle (α_s)

when side rake angle \uparrow

Strength \downarrow

forces \downarrow slightly

Power required \downarrow

Tool life \uparrow

• with increase in α_s the amount of chip bending in width direction reduces

Generally it's of $5-15^\circ$.

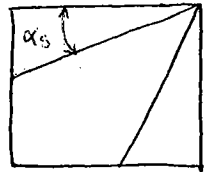

③ Relief angle (θ_e, θ_s)

Provided mainly for avoiding the rubbing action b/w tool and workpiece

with '0' relief angle; the tool is simply rubbing onto the work piece without doing any machining

Tool strength \downarrow

force required \downarrow slightly

Power consumption \downarrow slightly

Tool life \uparrow slightly

Generally θ_e and $\theta_s = 5$ to 15°

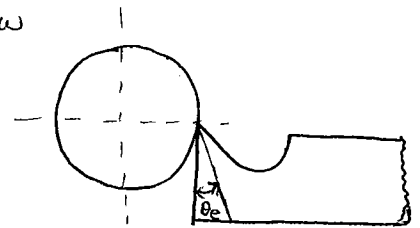

④ Cutting edge angle

Mainly influencing the surface finish produced in the work piece.

surface finish is measured using R_z

$R_z = \text{max peak to valley height}$

$$R_z = \frac{f}{\tan C_s + \cot C_e}$$

As increase in the value of R_z will indicate that the surface finish produced on the component is poor.

$C_e \uparrow$ $R_z \uparrow$ - poor surface finish

$C_s \uparrow$ $R_z \downarrow$ - Good surface finish.

$$C_e = 8-20^\circ$$

$$C_s = 0-90^\circ$$

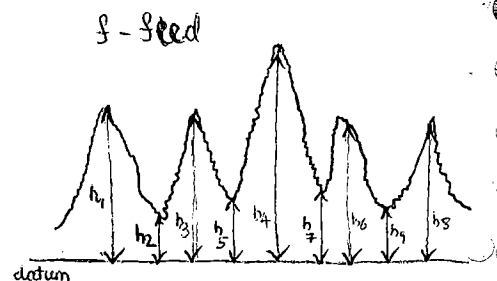

⑤ Nose Radius

With increase of nose radius - the surface finish produced on the workpiece would be better.

The surface finish obtained

$$R_z = \frac{f^2}{8r}$$

f - feed mm/rev

$r \uparrow \quad R_z \downarrow$ surface finish would be better.

on the otherhand on increase of nose radius the contact area b/w the tool and workpiece will increase. It increases the forces induced during machining, vibrations and chattering will take place.

This results into the poor surface finish.

The optimum nose radius which gives better surface finish is 0.2 to 1.2 mm

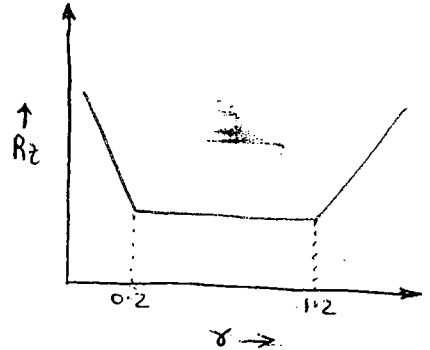
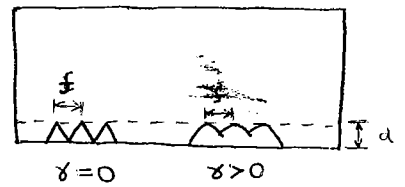

Q A tool 5-7-3-8-12-75-0.3mm ; feed = 0.1mm/rev - surface finish?

$$R_z = \frac{0.1}{\tan 75^\circ + \cot 12^\circ} = 0.0118$$

$$R_z = \frac{0.1^2}{8 \times 0.3} = 0.00416$$

Take the lowest (R_z) as the surface finish

Mechanism of chip formation:-

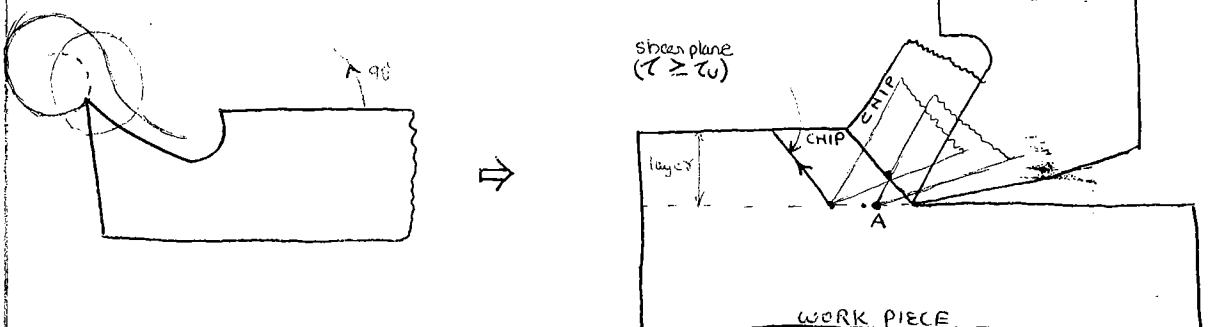

When the force is applied by using tip of the tool or to the layer of workpiece material; the material start deforming plastically and slide over the rake face of the tool producing shear stresses in the layer of work piece material. On further application of the force by using tip of tool; the shear stresses induced in the layer of work piece material are more

of work material so that the shearing or cracking ~~is~~ start taking place at the tip of the tool and propagate towards the surface producing shear plane and chip.

From the above the mechanism by which, the chip formation taking place is shearing and tearing.

During machining of soft workpieces - bcz of higher toughness, whatever the shear wave or energy wave propagating in the material is absorbed by the material and disappearing somewhere in the middle maintaining continuity of the chip at the topside. Hence continuous chips are produced.

In case of machining of hard and brittle work pieces bcz of lower toughness; the energy wave can propagate very easily upto the surface producing discontinuous chip.

built up edge formation

During machining - always microchips or powdered particles are produced and moving on the rake face of the tool.

When powdered particles are moving on the rake face; they may get adhered or welded on to the rake face bcz of presence of the very high temperatures at the chip tool interface.

This adhering of microchip on the rake face is called built up edge.

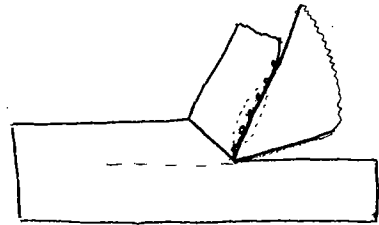

Built up edge formation is taking place only with continuous chips bcz in case of discontinuous chips ~~are~~ as and when the chip is producing, it is immediately thrown away from the machining zone. So that microchips also will be thrown away and no adhering will be taking place.

Due to the formation of built up edge - the advantage is that whatever the wear has to take place on the rake face, only built up edge is wearing out. Hence tool life increases.

But with the formation of built up edge - the surface finish of the rake face of the tool will reduce, the friction increases and forces and power consumption will increase.

Types of chips :-

① Discontinuous chip :-

Hard and brittle w.p when worked; irrespective of work conditions. Only discontinuous chips are formed.
if we work with soft work pieces
low speed

During machining of soft work pieces with low speed; the radius of curling of chip is low - amount of bending of the chip is high. \therefore the cracks which are already present in the chip will propagate easily and produces discontinuous chip.

small rake

With small rake angle; the forces in machining are higher - the magnitude of energy wave is high. \therefore it can easily propagate upto the surface and produces discontinuous chips.

large uncut chip.

During machining with large uncut chip thickness; the forces to be applied by using the tool is high and the magnitude of energy wave is high. \therefore the energy wave can easily propagate upto the surface.

* with use of cutting fluids

During machining operations bcz of high temperatures; the chip is expanding due to thermal expansion. When the cutting fluid is supplied into the machining zone - whatever the heat generated will be carried away by the cutting fluid; so that the temperature of the chip is reducing and it contracts. \therefore with in short duration the chip is expanding & then contracting. During the process of expansion & contraction any cracks which are present in the chip will propagate easily & converted into discontinuous chip.

② Continuous chip without builtup edge

Only possible with soft and ductile materials.

high speed machining.

large rake angle - forces and power consumption reduces; heat generation is reducing temperature is reducing and at low temperatures - the adhering of microchips will be eliminated.

Small uncut chip -

* with cutting fluids - heat carried away, so no-adhering.

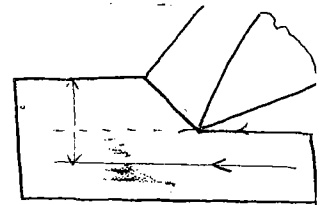
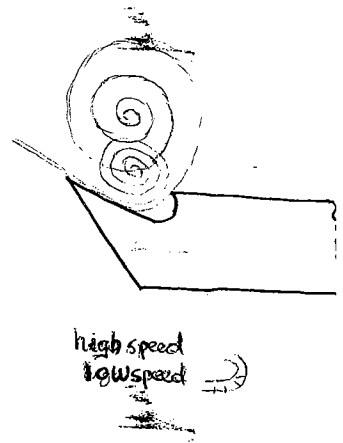

③ Continuous chips with built up edge.

Soft and ductile materials

Low speed

Small rake

Large uncut chip

without cutting fluid.

Q. During face turning of ductile workpiece material with optimum cutting velocity, from surface towards the centre. The type of the chips produced is.

(A) Continuous through out

(B) Discontinuous through out

(C) Continuous in beginning and discontinuous at end

(D) Discontinuous in beginning and continuous at end

$$V_c = \frac{\pi d N}{1000}$$

as d - reduces - V reduces

Thus V falls below optimum & thus forms discontinuous at end.

Ans 'C'

* In general, it's preferable to have the discontinuous chip bcs it's very easy to dispose them.

In certain situation, only continuous chips are produced, in such cases chip breakers are used to break them to discontinuous.

Methods of machining :-

① Orthogonal machining

If the cutting edge of the tool is \perp to the cutting velocity vector, it's called as orthogonal machining.

eg. - Jack plane operation used in carpentry.
parting off operation, sawing

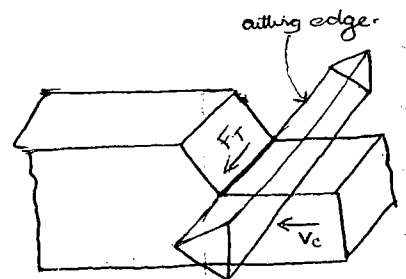

② Oblique machining

If the cutting edge of the tool is not \perp to the cutting velocity vector;

eg. - turning, shaping, drilling, milling.

whenever the machining is taking place. Two components of force will be acting. One parallel to the cutting edge called as thrust force and other acting \perp to the cutting edge called as cutting force.

In orthogonal machining - only F_T and F_c are acting. So they are also known as 2-dimensional cutting.

In oblique machining - F_c remains same; but F_T can be resolved to $F_T \cos \theta = F_a$ and $F_T \sin \theta = F_s$. Thus 3 components of forces are acting in machining. So it is also called as 3-dimensional machining.

But there are no direct methods available for analysis of oblique machining operation, it is always converted into orthogonal and analyse it as orthogonal.

31-8-11

R-5:30pm

ANALYSIS OF ORTHOGONAL MACHINING

Let $\alpha = \kappa_6$ (ASA)
 $= \alpha$ (ORS)

t_1 = uncut chip thickness

t_2 = thickness of chip after machining operation.

b_1, b_2 = width of the chip before and after machining operation respectively.

l_1, l_2 = length of the chip per revolution before and after machining operation.

ϕ = Shear angle or shear plane angle
 (angle made by shear plane w.r.t the cutting velocity vector)

V_c = Cutting velocity or relative velocity b/w the tool and workpiece

V_s = chip flow velocity or velocity of the chip relative to the tooling.

V_s = Shear velocity (velocity of chip relative to the workpiece) or shear plane velocity.

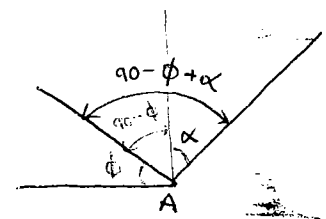
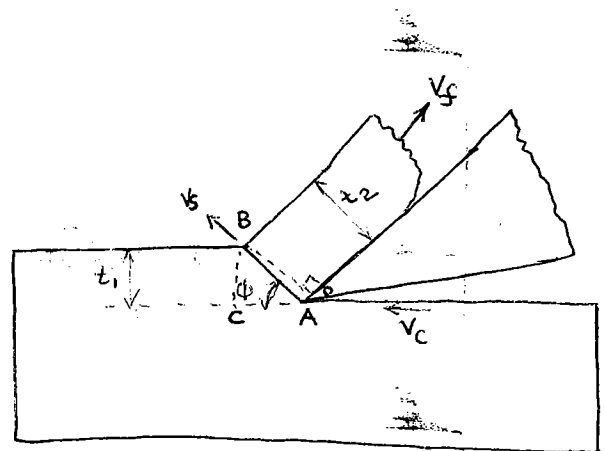

assumptions taken for the analysis of orthogonal machining are

① Every material undergoing machining operation is considered as incompressible i.e. the volumetric changes in the material is taken as zero. '0'

Vol of material before machining = volume of material after machining.

② Width of the chip remains constant

$$b_1 = b_2 = b$$

During machining operation, the force applied by using tip of the tool is acting like a compressive force along the length direction of the chip so that the volume is reducing in the length direction.

Bcz of incompressibility of the material, whatever the volume reducing the length direction has to be increased in the either thickness direction or width direction; but bcz the width of the chip is much higher than the thickness, the increase in volume takes place only in the thickness direction. Hence the width of the chip is taken as 'constant'.

$$\text{Vol. before} = \text{volume after}$$

$$t_1 b_1 L_1 = t_2 b_2 L_2$$

$$\frac{t_1}{t_2} = \frac{L_2}{L_1}$$

Also

$$t_1 b_1 V_c = t_2 b_2 V_f$$

$$\frac{t_1}{t_2} = \frac{V_f}{V_c}$$

$$\boxed{\frac{t_1}{t_2} = \frac{L_2}{L_1} = \frac{V_f}{V_c} = \gamma}$$

chip thickness ratio.

From ΔABC ,

$$\sin \phi = \frac{BC}{AB} = \frac{t_1}{AB}$$

$$\text{length of shear plane } AB = \frac{t_1}{\sin \phi} = L_s \quad \longrightarrow \textcircled{1}$$

From ΔABD ,

$$\sin(90 - (\phi - \alpha)) = \frac{BD}{AB} = \frac{t_2}{AB}$$

$$AB = \frac{t_2}{\cos(\phi - \alpha)} = L_s \quad \longrightarrow \textcircled{2}$$

$$\textcircled{1} = \textcircled{2}$$

$$\frac{t_1}{\sin \phi} = \frac{t_2}{\cos(\phi - \alpha)}$$

$$\frac{t_1}{t_2} = \frac{\sin \phi}{\cos(\phi - \alpha)} = \gamma$$

$$\Rightarrow \gamma = \frac{\sin \phi}{\cos \phi \cos \alpha + \sin \phi \sin \alpha}$$

\div numerator & denominator by $\cos \phi$

$$\tau = \frac{-\tan \phi}{\cos \alpha + \tan \phi \sin \alpha}$$

$$\tau \cos \alpha + \tau \tan \phi \sin \alpha = -\tan \phi$$

$$-\tan \phi - \tau \tan \phi \sin \alpha = \tau \cos \alpha$$

shear angle
OR
shear plane angle

$$\tan \phi = \frac{\gamma \cos \alpha}{1 - \gamma \sin \alpha}$$

$$\phi = f(\gamma, \alpha)$$

$$\gamma \uparrow \Rightarrow \phi \uparrow$$

$$\text{upto } 45^\circ \rightarrow \alpha \uparrow \Rightarrow \phi \uparrow$$

* compared to cos, sin has greater var

$\cos 0 = 1$	$\sin 0 = 0$
$\cos 10 = 0.98$	$\sin 10 = 0.17$
$\cos 20 = 0.93$	$\sin 20 = 0.34$
$\cos 30 = 0.86$	$\sin 30 = 0.5$

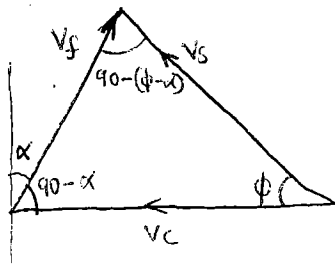

applying sin rule

$$\frac{V_c}{\sin(90 - (\phi - \alpha))} = \frac{V_f}{\sin \phi} = \frac{V_s}{\sin(90 - \alpha)}$$

$$\frac{V_c}{\cos(\phi - \alpha)} = \frac{V_f}{\sin \phi} = \frac{V_s}{\cos \alpha}$$

also

$$\frac{V_f}{V_c} = \frac{\sin \phi}{\cos(\phi - \alpha)} = \gamma$$

better derive than must

forces

F = frictional force acting on the rake face of the tool.

N = force normal to the frictional force.

F_s = shear force acting along the shear plane.

F_{SN} = force normal to the shear plane.

These are the 4 actual forces acting during machining operation.

But these forces are not measurable.

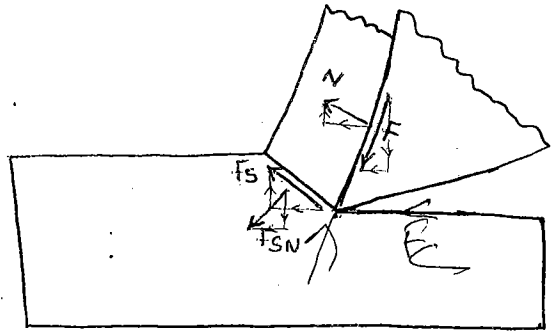

F_H - algebraic sum of the horizontal components of the 4 actual forces $\boxed{F_T}$ - Thrust force

F_V - Vertical component of 4 actual forces (algebraic sum) $\boxed{F_C}$ - Cutting force

These vertical and horizontal forces could be measured by using a dynamometer or spring balance.

F_H and F_V are actually the resolved components of actual forces.

They are also known as measurable forces: (F_T, F_C)

The actual forces are been used in analysis. Since these forces are not measurable. Thus we would find a relationship b/w the measurable force with actual force.

Actual forces are been obtained from the measurable force by using merchant's circle and by using the actual forces machining operations could be analysed.

Resultant force

$$R = \sqrt{F_C^2 + F_T^2}$$

This resultant force could be assumed as the diameter of the merchant circle.

In merchant circle it is found that 3 right angled Δ 's are present and all the 3 triangles are posing common hypotenuse.

This is used as a basis for establishing the relationship between, the measurable and the actual forces.

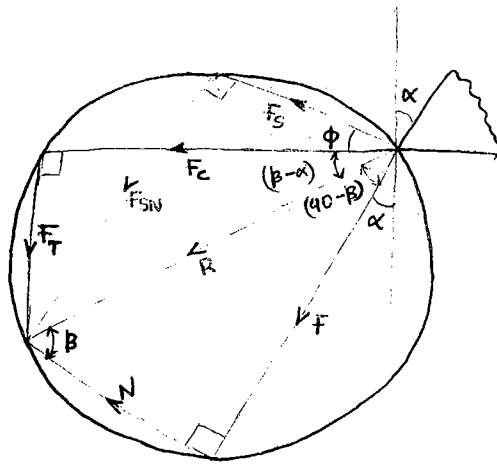

In fig:-
 F_T is vertical and F_C is horizon
 (This is bc3)

In theoretical explanation forces are referred based on the actual machining operation

But merchant circle is been dra based on machining zone diag (which is been ~~transformed~~ by 9 in anticlockwise direction)

$$\sin \beta = \frac{F}{R}$$

$$R = \frac{F}{\sin \beta} = \frac{N}{\cos \beta} = \frac{F_c}{\cos(\beta - \alpha)} = \frac{F_T}{\sin(\beta - \alpha)} = \frac{f_s}{\cos(\phi + \beta - \alpha)} = \frac{F_{SN}}{\sin(\phi + \beta - \alpha)}$$

α - came from the tool designation

ϕ - we could calculate from the eqn for shear angle.

β - ?

$$\tan(\beta - \alpha) = \frac{F_T}{F_C}$$

$$\beta = \alpha + \tan^{-1}\left(\frac{F_T}{F_C}\right)$$

also the coefficient of friction at chip tool interface $\mu = \tan \beta$

for detailed eqn for finding coefficient of friction.

$$\tan(\beta - \alpha) = \frac{F_T}{F_C}$$

$$\frac{\tan \beta - \tan \alpha}{1 + \tan \beta \tan \alpha} = \frac{F_T}{F_C}$$

$$F_C \tan \beta - F_C \tan \alpha = F_T + F_T \tan \beta \tan \alpha$$

bring $\tan \beta$ to one side and $\tan \alpha$ to other side

$$F_C \tan \beta - F_T \tan \beta \tan \alpha = F_T + F_C \tan \alpha$$

$$\tan \beta = \frac{F_T + F_C \tan \alpha}{F_C - F_T \tan \alpha} = \mu$$

In general cases cutting force > thrust force is $F_c > F_T$

In special cases $F_T > F_c$ - Facing, brooding, broaching

$$\frac{F_T}{F_c} \approx 2.5 \quad \text{for grinding.}$$

$\beta = \alpha + \tan^{-1}\left(\frac{F_T}{F_c}\right)$ since $\frac{F_T}{F_c} > 1$ $\tan^{-1}\left(\frac{F_T}{F_c}\right) > 45^\circ$ so whatever be the α value $\beta > 45^\circ$ [friction angle $\beta > 45^\circ$]

$\mu = \tan \beta$ \rightarrow Thus coeff of friction μ become > 1 . But in general μ should be less than 1. Hence for the cases where the coefficient of friction become > 1 , classical friction theorem will be used to determine μ .

According to Classical friction theorem :-

$$\mu = \frac{\ln\left(\frac{1}{\gamma}\right)}{\frac{\pi}{2} - \alpha}$$

or
$$\mu = \frac{\ln(K)}{\frac{\pi}{2} - \alpha}$$

where $K = \frac{1}{\gamma} \Rightarrow$ coefficient of elongation

$$K = \frac{1}{\gamma} = \frac{t_2}{t_1} = \frac{L_1}{L_2} = \frac{V_c}{V_f}$$

$\alpha =$ rake angle in radians

* It's applicable only if μ is found > 1 when calculated otherwise.

Shear stress induced

$$\tau = \frac{F_s}{A_s}$$

$$\begin{aligned} \tau &= \frac{F_s}{b \times L_s} \\ &= \frac{F_s}{b \times \frac{t_1}{\sin \phi}} \\ &= \frac{F_s \times \sin \phi}{b \times t_1} \end{aligned}$$

$$\tau = \frac{F_s \sin \phi}{A_0}$$

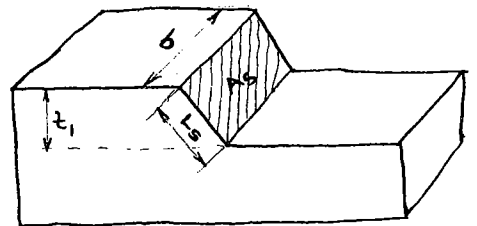

A_0 - Area of uncut thickness

For possible machining operation τ must be \geq ultimate shear stress of the work material.

Shear strain

ABCD - Initial chip

FECD - Final chip

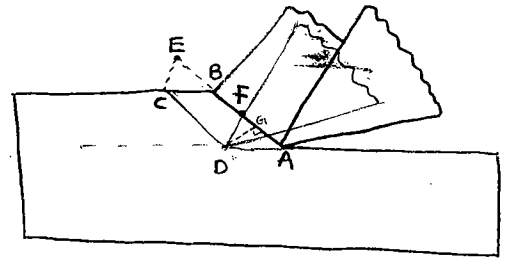

$$\text{Shear strain} = \frac{\text{Deformation in chip at the line of fracture}}{\text{Shortest distance b/w two shear planes}}$$

$$= \frac{AF}{DG}$$

$$= \frac{AG}{DG} + \frac{GF}{DG}$$

$$\boxed{SS = \cot \phi + \tan(\phi - \alpha)}$$

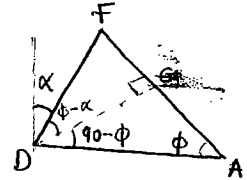

For a given tool; the α is fixed; \therefore the shear strain mainly depends on the shear angle ϕ

For minimum shear strain is to be induced in the chip;

$$\frac{d(SS)}{d\phi} = 0$$

$$2\phi - \alpha = 90$$

$$\boxed{\phi = \frac{90 + \alpha}{2}}$$

optimum shear angle relationship for minimum shear strain in chip.

WORK DONE OR ENERGY OR POWER REQUIRED FOR MACHINING OPERATION

$$WD = E = P = F_{oc} \times \text{Velocity} + F_T \times \text{feed velocity}$$

$$= F_c \times V_c + F_T \times \text{feed velocity}$$

$$P = F_c \times V_c$$

$$\text{Feed velocity} = f \times N$$

$$= 0.1 \times 500 \text{ rpm}$$

$$= 50 \text{ mm/min}$$

$$= \frac{50 \times 10^{-3}}{60} \text{ m/s}$$

$$= 0.000833 \text{ m/s}$$

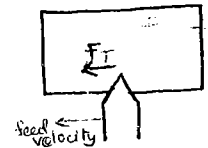

In actual practice - the shear stresses induced in the machining is $>$ the ultimate shear stresses; so that work done will be high; but if it is required to perform the machining operation; the minimum shear stresses to be induced is just equal to the ultimate shear stresses. The corresponding

$$W \text{ or } P = F_c \times V_c$$

$$= \frac{F_s}{\cos(\phi + \beta - \alpha)} \times \cos(\beta - \alpha) \cdot V_c$$

$$= \frac{A_0 \tau}{\sin \phi} \frac{\cos(\beta - \alpha)}{\cos(\phi + \beta - \alpha)} \cdot V_c$$

$$\tau = \frac{F_s}{A_0} \times \sin \phi$$

$$F_s = \frac{A_0 \tau}{\sin \phi}$$

For minimum work done.

$$\frac{d(W \cdot P)}{d\phi} = 0$$

$$2\phi + \beta - \alpha = 90$$

$$\phi = \frac{90 + \alpha - \beta}{2}$$

Optimum shear angle relation for minimum work done in machining operation.

OR

MINIMUM ENERGY CRITERIA OF MACHINING

OR

MERCHANTS CRITERIA

To validate this equation practically, Lee & Shaffer has tried to conduct experiments. ^(Merchant's shear angle relation) But they failed to prove the merchant's shear angle relation.

They proved another optimum shear angle relation at which the minimum energy of machining will be taking place.

$$\phi + \beta - \alpha = 45^\circ$$

Lee & Shaffer shear angle relation

This equation is ~~not~~ obtained by experimentation.

It has not been proved theoretically.

Simultaneously Stabler also conducted experiments for proving the merchant's shear angle relation. But he also failed. He obtained another shear angle relation.

$$\phi + \beta - \frac{\alpha}{2} = 45^\circ$$

Stabler shear angle relation.

*In exam; if simply mentioned - use merchant's relation.
if mentioned use other equations. Once ~~the~~ Lee and Shaffer was asked.

Machining constant or Merchant's constant (C_m)

$$C_m = 2\phi + \beta - \alpha \approx 90^\circ$$

Merchant's constant is used for indicating the amount of shear stresses induced in the material and also the efficiency of energy utilization during machining operation.

$$\text{If } C_m = 2\phi + \beta - \alpha = 90^\circ$$

$$- \tau = \tau_u$$

- work done is minimum

$$- \eta_{\text{energy utilization}} = 100\%$$

$$\text{If } C_m = 2\phi + \beta - \alpha > 90^\circ$$

- $\tau < \tau_u$ [impossible case of machining operation]

$$\text{If } C_m = 2\phi + \beta - \alpha < 90^\circ$$

$$- \tau > \tau_u$$

$$- \eta_{\text{EU}} < 100\%$$

* For every 1° reduction in the machining constant from 90° , nearly 1% reduction in the efficiency of energy utilization $[\eta_{\text{EU}}]$ will take place

$$\text{Q. Thus for } C_m = 65^\circ \quad \eta = ?$$

$$\text{Reduction} = 90 - 65 = 25^\circ$$

$$\eta_{\text{EU}} = 100 - 25 = \underline{\underline{75\%}}$$

Specific Cutting Energy

The amount of energy required to remove unit volume of material from the work piece.

$$\text{Sp. Cutting Energy} = \frac{\text{Work Done}}{\text{Material Removal Rate}} \quad \frac{\text{J}}{\text{m}^3}$$

$$= \frac{WD}{MRR}$$

$$= \frac{F_c \times V_c}{t_1 \times b \times V_c} \quad A_0 = z_1 \times b$$

$$\text{Sp. Cutting Energy} = \frac{F_c}{t_1 \times b} = \frac{F_c}{A_0} \quad \frac{\text{N}}{\text{mm}^2}$$

$$\boxed{\text{Sp. C.E} = \frac{F_c}{A_0}}$$

But, the units of specific cutting energy can also be taken as pressure units, the specific cutting energy can also be called as a specific cutting pressure or specific cutting force.

The specific cutting energy will be used for indicating the machinability of the work piece material.

Higher the specific cutting energy for a given material indicate that lower is the machinability of work piece material and viceversa.

Factors affecting the forces in machining

(1) Process Parameters

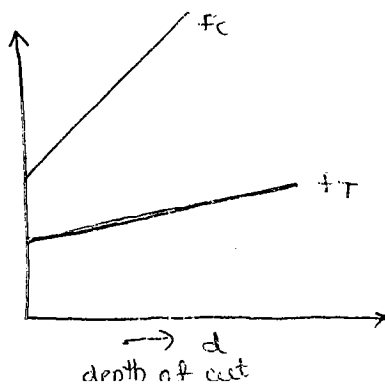
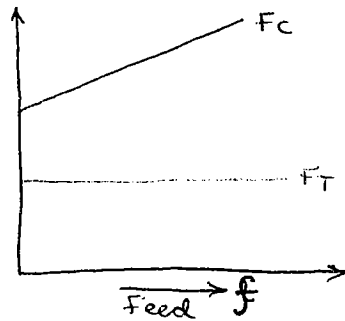
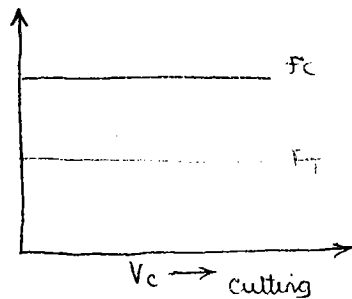

slope of F_c is more.

② Back rake angle (α_b)

For every 1° increase in the rake angle nearly 10% reduction in the f_s in machining will take place from the previous value.

$$\alpha_b \uparrow \quad F_T, F_c \downarrow$$

③ Use of cutting fluids or coolants

Reduces forces in machining by about 25-40%

④ In case of orthogonal machining

In case of orthogonal machining only 2 forces are only acting. F_c and F_T . F_c will be 33% and F_T is 66%.

$$\text{Thus ratio of } F_c : F_T = 2 : 1$$

⑤ In case of oblique machining

$$\left. \begin{array}{l} F_c \rightarrow 67\% \\ F_T \rightarrow \begin{cases} 27\% (F_a) \\ 6\% (F_s) \end{cases} \end{array} \right\} F_c : F_a : F_s = 11 : 4.5 : 1$$

Heat Generation in Machining

According to 1st law of thermodynamics; whatever be the energy supplied to machining operation would be simply converted into heat energy only.

$$H_{Gr} = W \cdot D = F_c V_c$$

Whatever the energy supplied for machining would be converted to heat energy by 3 zone wise.

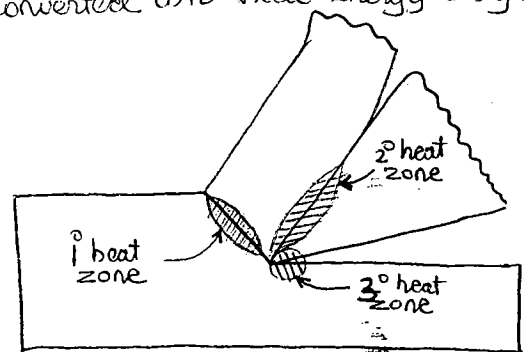

① 1° heat zone

In primary heat zone; the energy is supplied for breaking the atomic bond b/w the atoms of the material; so that the atoms release equivalent amount of energy in the form of heat energy. \therefore the heat is generated in the 1° heat zone.

60-65% of energy supplied is utilized in 1° zone.

The maximum amount of heat is carried away by the chip and some small amount of heat is carried away by the w.p.

② Secondary heat zone

Bcz of presence of friction at the chip tool interface, the energy supplied is converted into heat energy.

30-35% of energy supplied is converted to heat in this zone.

Maximum amount of heat generated in 2^o zone is been carried away by the chip and a small amount carried away by the tool.

③ Tertiary heat zone

The energy supplied is converted into heat energy bcz of presence of friction at the tool work interface.

5-10% of energy supplied is converted to heat in this zone.

Out of the heat generated in this zone; maximum is carried away by the workpiece and small amount is carried away by the tool.

By neglecting heat energy lost to the surroundings or environment by convection and radiation, whatever be the heat generated in the machining operation is simply carried away by the chip, workpiece and the tool in decreasing order.

$$H \cdot G = W \cdot D = W = \text{heat carried away by } \left(\underbrace{\text{chip}}_{75-90\%} + \underbrace{w \cdot P}_{15-20\%} + \underbrace{\text{Tool}}_{5-8\%} \right)$$

Bcz the heat carried away by tool is very small and if neglected;

$$\text{Heat Generated} = \text{heat carried away by (chip + w.P)}$$

Bcz the chip is carrying away the maximum amount of the heat; the rise in temperature of the chip is maximum and if this temperature is very near to the melting point temp of work piece, the chip may get adhered back either on the workpiece or on the tool.

To avoid this, 1st determine the rise in temperature of the chip. If it goes near to the M.P; adjust the process parameters such that the temperature induced during machining is well below the M.P temp of work material.

$$\text{Heat carried by Chip} = W - \text{heat carried away by w.P}$$

$$= W - aW$$

$$= W(1-a)$$

a - fraction of heat generated which is carried away by w.P (0.15 - 0.2)

$$mC_p \Delta T = W(1-a)$$

$$\Delta T = \frac{w(1-a)}{m C_p} = \frac{w(1-a)}{Vol \times \rho \times C_p}$$

$$= \frac{f_c \times V_c (1-a)}{Vol \times \rho \times C_p} = \frac{f_c \times V_c (1-a)}{(A_0 V_c) \rho \times C_p}$$

$$\Delta T = \frac{f_c (1-a)}{(t_1 \times b) \rho C_p}$$

Temp of chip

$$T_{chip} = \Delta T + T_\delta$$

T_δ - room temp

In machining operation; all the 3 heat zones meet at one junction, i.e. at the tip of the tool so that the temperature at the tip of the tool becomes very high. If this temperature goes beyond the hot hardness temp of tool material, tool tip loses its hardness considerably and it deforms plastically so that it cannot perform the machining operation satisfactorily after. To avoid this, practically measure the temp. of tip of the tool; if it goes beyond the hot hardness temperature; either change the tool material or change the process parameters such that the temperature induced is $<$ the hot hardness temp. of tool material.

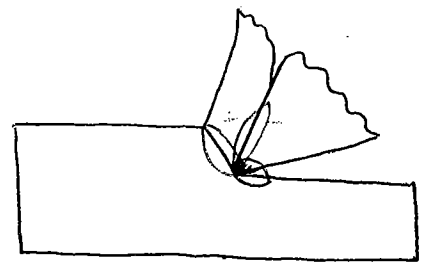

methods of measurement of tool tip temperature

① Tool-work thermocouple

A small hole will be drilled at the tool tip such that it will not affect the strength of the tool material.

Bcz of existence of temp difference b/w the 2 junctions of thermocouple an emf will flow through the circuit due to Seebeck effect, Peltier effect and Thomson effect.

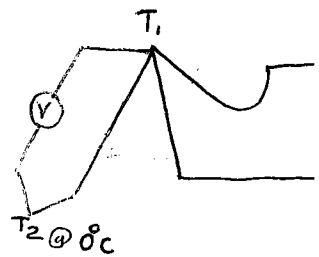

This emf is directly proportional to temp. difference.

$$emf \propto \text{temp. diff.}$$

$$\propto (T_1 - 0)$$

$$emf \propto T_1$$

Limitations:-

① They are generally used for measurement of temperatures accurately up to 500°C. beyond which the accuracy is poor.

* Temp induced at the tip of the tool during machining of Titanium alloy is about $15,000 \pm 18,000^\circ\text{C}$.

② Bob-walk thermocouple could be used only for measurement of temperature of stationary tools. (can't be used for moving or rotating tools) (drilling bit, shaping tool etc.)

② Optical Pyrometer

Non contact type of temp measurement equipment. (lim ① is overcome)

③ Calorimetric setup

Limitation ② is overcome.

Tool failure

Whenever the tool is not performing the machining operation satisfactorily, it is assumed that the tool has been failed.

parameters indicating satisfactoriness of machining - which is to be measured online.

① Surface finish

At the beginning of machining operation the surface finish looks like a mirror. After some time of machining when the lines are observed on the machined surface - it indicates the tool failure.

② Forces in machining

During machining - the forces induced will be measured online using dynamometers.

Whenever the increase in forces during machining is greater than 15% indicate that machining is not satisfactory and tool is assumed to be failed.

③ Power consumption

Whenever the forces are increasing - power consumption also increases.

This is being measured by mounting the ammeter at the inlet of electrical motor and current drawn by the motor is monitored.

Whenever the increase in current drawn by the motor is more than 15% it's assumed that the tool has been failed.

④ Colour of the chip:-

During normal machining conditions ; the colour of the chip is found to be metallic or light blue colour.

whenever the colour of the chip is changed black or burnt type of colour - it's assumed that the tool has been failed.

⑤ Machining of high carbon steel WP

During machining of high carbon work piece with failed tool. Bcz of higher temperature ; the carbon present on the surface of the workpiece get easily combined with the oxygen present in the atmosphere and produces carbon monoxide which is observed as a white coloured gas. it whenever machining of high carbon working pieces - if white white coloured gases are observed observed - it's assumed that tool is failed.

Modes of tool failure

① Failure through plastic deformation - abnormal failure.

During machining operation ; if the temp at the tip of the tool is $>$ the hot hardness temp of tool material, tool tip is using its hardness considerably, ~~and~~ it deforms plastically and cannot perform the machining satisfactorily called as plastic deformation failure of the tool.

This is mainly bcz of wrong selection of the tool materials or the wrong selection of the process parameters - Non repeatable failure

② Failure through mechanical breakage - abnormal failure

Initially the tool performing or machining satisfactorily ; gets its tip chipped away and cannot perform machining satisfactorily.

This happens due to the presence of blow holes in the workpiece or hard inclusions in the workpiece so that during machining of blowholes and hard inclusions - the forces will be increased suddenly and the tip of tool chips away.

On similar conditions of machining - the failure duration of the tool is not repeatable. \therefore it's also considered as abnormal failure and is not ~~is~~ considered for tool life calculation.

③ Failure through Gradual wear :- normal failure

During machining operation - the tip of tool wears out slowly so that whenever the wear on the tool becomes considerable & it cannot perform the machining satisfactorily and assumed that the tool is failed.

The gradual wear failure mainly take place due to 2 types of wear mechanisms.

- (a) Crater wear
- (b) Flank wear

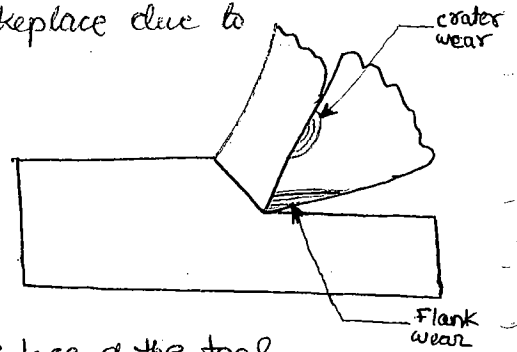

(a) Crater wear

Wear taking place on the rake face of the tool like a crater is called crater wear.

Crater - shallow spherical depressions on the surface

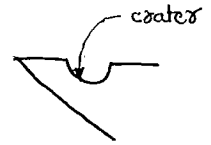

This is caused due to

- the presence of friction in the chip-tool interface
- abrasive action of microchips present on chip-tool interface
- abrasive action of fragments of built-up edge present on the chip-tool interface.
- diffusion wear - Sometimes during machining bcz of atomic attractions b/w the tool and the work piece - the atoms of the tool material are diffusing from the tool and depositing over the work piece.

eg:- during machining of Ferrous workpieces using diamond cutting tool. Since in diamond pure carbon is present. Thus atoms of C will be attracted by iron.

Q During machining operation, the crater wear will start at some distance away from the tip of the tool. Why?

When the upward force is applied by using tip of the tool; the chip produced is lifting directly upward. But bcz of self wt of the chip; it is falling back on the rake face of the tool. In the process of lifting upward and falling back on the rake face, no contact is existing b/w the tip of the tool and chip. ∴ no friction ⇒ no abrasive action ⇒ no diffusion.

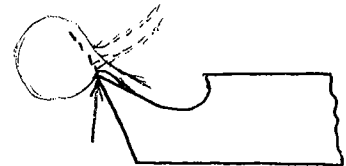

When the chip is falling back on the rake face of the tool, it is trying to penetrate into the tool at some distance away from the tip of the tool; at that point; the friction is high, heat generation is high; temperature is high. Due to high temp - the mechanical properties of tool material at that point deteriorates. which will increase the wear of the tool and produces crater.

(b) Flank wear

The wear taking place on the flank face of the tool

This is caused due to :-

⑥ Shear angle

Under similar conditions of machining if the shear angle produced is \uparrow machinability is \uparrow

⑦ Type of chip produced.

Discontinuous chip \Rightarrow better machinable

The above methods could only be used to compare 2 or more w.p. Thus they are only applicable if more than 1 w.p. is given; then only we could conduct machining on those w.p.s and measure any one of these parameters and based on that; the decision of higher machinability w.p. are taken.

When only one w.p. is given, the machinability can be determined by comparing with standard w.p. and calculate the machinability index. Using this machinability index; the easiness of machining of a workpiece can be determined.

Machinability Index

$$MI = \frac{V_T}{V_S}$$

V_T - cutting velocity for 60 min tool on a test w.p.

V_S - cutting velocity for 60 min tool on a standard workpiece.

Free cutting Steel or Free Machin is used as standard w.p.

addition of Sulphur or Phosphorus above 0.05% also increases the machinability but the increase in brittleness is very high. \therefore the material cannot be used in engineering application.

Any steel upto 0.05% - phosphorus
(low or mid or high) upto 0.05% - sulphur upto 2-4% - lead is called FCS or FMS

Why free cutting ^{Steel} Material as standard?

While formulating MI; the FCS was known to have highest possible machinability.

But later on many materials were found to be having greater machinability than FCS. Hence value of MI - could be 'any value' (> 0 or < 1)

Addition of lead more than 4% also increases the machinability further but it reduces the MP of steel drastically. So - only 4%.

Another machinability is also been defined - Universal Machining Index (UMI)

or also called Absolute Index - bcz it even does not require even standard w.p.

$$UMI = \frac{\cos(\beta - \alpha)}{\cos(\phi + \beta - \alpha)} = \frac{F_c}{F_s}$$

Economics of Machining

The method of determining the optimal process parameters for a given economic criteria machining is called economics of machining.

Out of the process parameters; the cutting velocity is having the highest influence on the machining.
 ∴ the optimum cutting velocity is only determined.

- ① Minimum Cost Criteria
- ② Maximum Production Criteria
- ③ Maximum Profit Criteria

① Minimum Cost Criteria :-

Total Cost

$$TC = C_0 + C_{LSS} + C_m + C_t + C_{VBI}$$

out of the above costs - the cost of machining and cost of tooling would be influenced by cutting velocity.

- C_0 - cost of raw material
- C_{LSS} - cost of loading and setting
- C_m - cost of machining
- C_t - cost of tooling
- C_{VBI} - cost of conveying & inspection.

$$TC = K_1 + C_m + C_t$$

$$E_m = T_m \times L_m$$

$$T_m = \frac{L}{f \times N} \quad (\text{next chapter})$$

$$C_m = \frac{\pi D L \times L_m}{1000 f V}$$

$$E_m \propto \frac{1}{V}$$

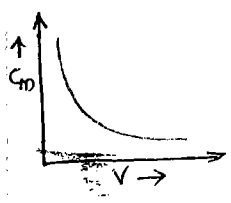

$$C_t = \frac{T_m}{T} \times C_g$$

$$= \frac{L/fN}{T} \cdot C_g$$

$$\left(\frac{C}{V} \right)^{1/n}$$

$$VT^n = C$$

$$C_k = \frac{\pi D L V^{\frac{1}{n}-1}}{1000 f C_g^{1/n}} \cdot C_g$$

$$C_k \propto V^{\frac{1}{n}-1}$$

- T_m - machining time for 1 component (minutes)
- L_m - machining labour charges in Rs/min.
- $N = \frac{1000 V}{\pi D}$

- T_m - machining time
- T - tool life
- C_g - cost of resharpening tool / time (if resharpenable) or cost of 1 cutting edge (if it is a throwaway type of tip of tool)

* If cost of a tool is given - one tool has 4 cutting edge (flutes) so divide by 4 to get cost of 1 cutting edge

- presence of friction in the tool-work interface
- abrasive action of microchips present at the tool-work interface
- diffusion wearing

Tool life

Actual machining time between 2 successive regrinds of cutting tool
Generally it's expressed in minutes.

It's also defined as number of pieces produced b/w the successive regrinds of a cutting tool.

This methodology is best used in mass production.

It's also defined as the vol. of material removed b/w two successive regrinds of a cutting tool.

This methodology is used for rough machining.

Factors influencing tool life

① Properties of work material

As the hardness of work piece increases; the forces in machine \uparrow , tool wear \uparrow , tool life \downarrow

With an increase of ductility of workpiece material, the forces \downarrow , tool wear \downarrow , tool life \uparrow

② Tool Geometry

back rake angle $\alpha_b \uparrow \Rightarrow$ tool life \downarrow . Qualitatively we could tell this but no quantitative relation.

③ Use of cutting fluid

When cutting fluids are used; forces in machining reduces by about 25-40% so that the wear of the tool is reducing and tool life increases by about 25-40%.

④ Process parameters (v, f, d):-

As the process parameters are unique and independent; the researchers try to correlate process parameters with tool life quantitatively.

Out of the 3 parameters 'Taylor' first assumed that the cutting velocity is the one which has the highest influence on the tool life. Hence the Taylor has invented quantitative relationship b/w the tool life and cutting velocity and named as Taylor's tool life equation.

$$VT^n = C$$

n - Taylor's exponent (depends on cutting material)
 V - cutting velocity - m/min
 T - tool life - (min) or (hr)

Taylor's constant - cutting velocity for 1 minute tool life.

n - 0.05 - 0.1	-	HCS
0.1 - 0.2	-	HSS
0.2 - 0.4	-	Carbide
0.4 - 0.6	-	Ceramics
0.7 - 0.9	-	Diamond/CBN

Later on Taylor has invented the relationship b/w the tool life and other process parameters also; called as modified Taylor's tool life eqn:

$$v T^n f^p d^q = C$$

f - feed in mm/rev

d - depth of cut in mm

p, q - exponents

value < 1

In general $p > q$

out of the 3 process parameters, the cutting velocity have highest influence on the tool life, depth of cut is having lower influence and feed is in between.

$$v > f > d$$

Machinability

The ease with which machining of a given work piece can be done is called machinability.

parameters determining machinability (check or measure)

① Surface finish

Under similar conditions of machining, the w.p on which better surface finish is produced is called as better machinable.

② Tool life

Under similar conditions of machining, the w.p on which higher tool life is obtained is better machinable.

③ Forces in machining

Under similar conditions of machining, the w.p on which the forces induced are lower is called better machinability w.p.

④ Specific cutting energy:-

Under similar conditions of machining, lower the specific cutting energy, higher the machinability.

⑤ Material Removal Rate

Under similar conditions of machining, higher MRR can be obtained is better machinable.

$$TC = K_1 + \frac{\pi DL}{1000 fV} L_m + \frac{\pi DL V^{1-n}}{1000 f c^{1/n}} \cdot C_g$$

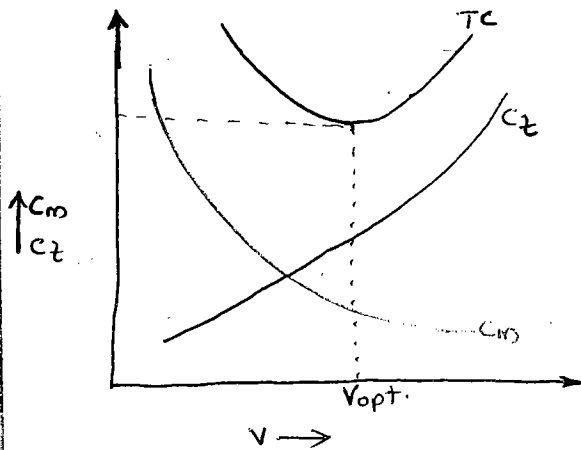

For minimum TC

$$\frac{d(TC)}{dV} = 0$$

$$V_{opt} = c \left[\frac{n}{1-n} \cdot \frac{L_m}{C_g} \right]^n$$

substituting value of V_{opt}
optimum tool life

$$T_{opt} = \left(\frac{C}{V_{opt}} \right)^{1/n}$$

$$T_{opt} = \left[\frac{1-n}{n} \cdot \frac{C_g}{L_m} \right]$$

C - Taylor's constant

n - Taylor's exponent

L_m - machining labor charge in Rs

V_{opt} - Optimum cutting velocity

T_{opt} - Optimum tool life

② Maximum Production Criteria

This refers to minimum total time

Total Time

$$TT = T_{LBS} + T_m + T_{tc} + T_{undI}$$

T_{tc} - tool changing time

out of above times only machining time and tool changing time (T_{tc}) are influenced by the cutting velocity

$$TT = K_2 + T_m + T_{tc}$$

$$T_m = \frac{L}{F_N} = \frac{\pi DL}{1000 fV}$$

$$T_m \propto \frac{1}{V}$$

$$T_{tc} = \frac{T_m}{T} \times T_c$$

$$= \frac{\pi DL V^{1-n}}{1000 f c^{1/n}} \cdot T_c$$

T_c - time needed to change the tool one time

$$T_{tc} \propto V^{\frac{1}{n}-1}$$

$$TT = K_2 + \frac{\pi DL}{1000fV} + \frac{\pi DL V^{\frac{1}{n}-1}}{1000f c^{1/n}} \cdot T_c$$

For minimum total time.

$$\frac{d(TT)}{dV} = 0$$

$$V = V_{opt} = c \left[\frac{n}{1-n} \cdot \frac{1}{T_c} \right]^n$$

$$T_{opt} = \left[\frac{1-n}{n} \cdot T_c \right]$$

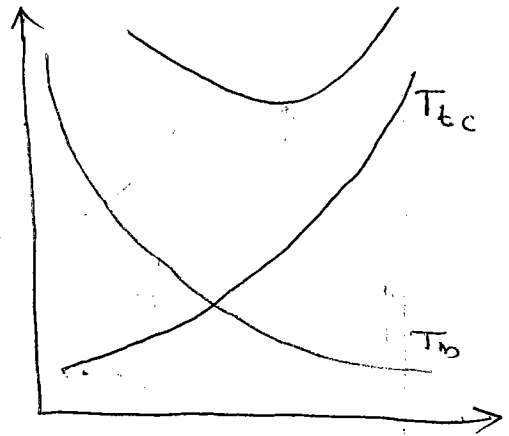

③ Maximum Profit Criteria

$$\uparrow \text{Profit} = S \cdot P - T \cdot C \downarrow$$

As the selling price is not influenced by the cutting velocity, the profit can be maximized by minimising the total cost.

∴ maximum profit criteria is nothing but the minimum cost criteria.

$$\text{so } V_{opt} = c \left[\frac{n}{1-n} \cdot \frac{L_m}{c_g} \right]^n$$

$$T_{opt} = \left[\frac{1-n}{n} \cdot \frac{c_g}{L_m} \right]$$

$$(V_{opt})_{\text{min. cost}} = (V_{opt})_{\text{max profit}}$$

But if we consider the surface finish — (there is no quantitative relationship between velocity, cutting velocity and surface finish)

when $V \uparrow \Rightarrow$ surface finish $\uparrow \Rightarrow$ Quality $\uparrow \Rightarrow$ Sp could be increased

$$\text{Thus, } (V_{opt})_{\text{max profit}} > (V_{opt})_{\text{min cost}}$$

Thus the cutting velocities for maximum profit would be slightly higher than that for minimum cost.

- ① Vopt for min cost
- ② Vopt for max. Product
- ③ Vopt for max profit

$$② > ③ > ①$$

Effective Rake and Relief angle

During turning operation - it is required to set the tool such that the tip of the tool can coincide with the axis of the workpiece.

This setting of the tool will be done with reference to the dead centre of tailstock, just by seeing through human eye.

During setting, by mistake, the tool tip may set slightly above or below the workpiece; this will affect the machining operation.

When tool is set above central line

- ① Effective rake angle \uparrow
 Forces \downarrow
 Power consumption \downarrow
 Tool life \uparrow
- ② Effective relief angle \downarrow
 Rubbing action b/w tool & work piece \uparrow

In case of parting off operation, if tool is set above the centre line of work piece, as the tool is proceeding towards the centre of revolution in radius; even though offset remains same - the offset angle will increase \uparrow & effective relief angle \downarrow . At some point; the effective relief angle may become equal to '0'. So that the tool is simply working rubbing on the workpiece without doing any machining.

If R' is the radius at which $\theta_{ee} = 0$

$$\sin \theta_f = \frac{OF}{R'}$$

$$R' = \frac{OF}{\sin \theta_f} = \frac{OF}{\sin \theta_e}$$

when $\theta_{ee} = 0$ $\theta_f \rightarrow \theta_e$

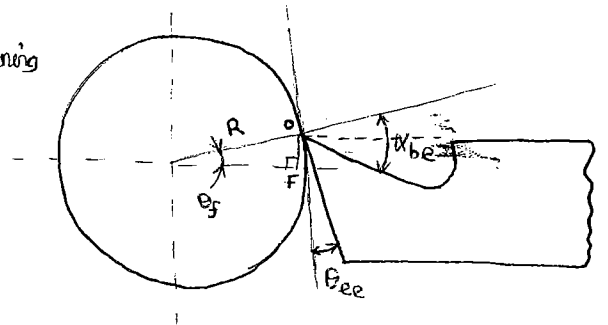
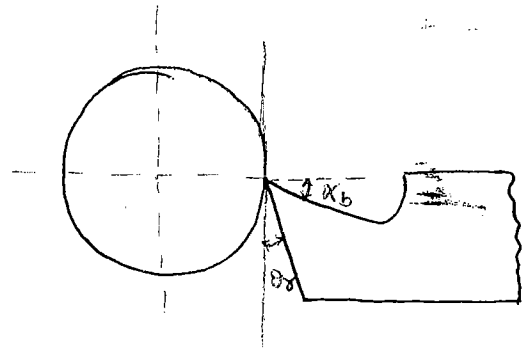

$$\sin \theta_f = \frac{OF}{R}$$

$$OF = \sin^{-1} \left(\frac{OF}{R} \right)$$

$$\alpha_{be} = \alpha_b + \theta_f$$

$$\theta_{ee} = \theta_e - \theta_f$$

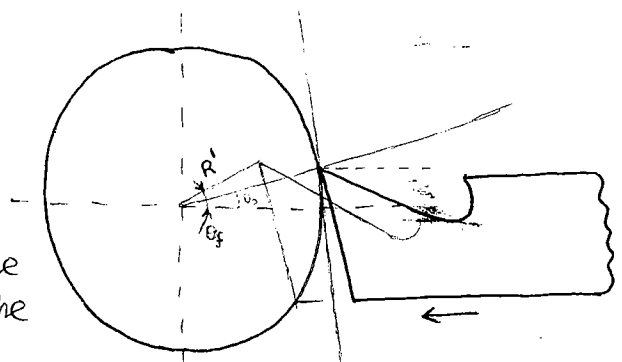

eg:- $D=50\text{mm}$, $Of=1.5\text{mm}$, $\alpha_b=10^\circ$, $\theta_c=6^\circ$ find dia at which the tool just subs.

$$\theta_f = \sin^{-1}\left(\frac{1.5}{25}\right)$$

$$\alpha_{bc} = 10 + \theta_f$$

$$\theta_{ee} = 6 - \theta_f$$

$$R' = \frac{1.5}{\sin 6^\circ}$$

$$D' = 2 \times R' = \underline{\underline{28.7\text{mm}}}$$

Setting below centre line

$$\theta_f = \sin^{-1}\left(\frac{Of}{R}\right)$$

$$\alpha_{be} = \alpha_b - \theta_f$$

$$\theta_{ee} = \theta_e + \theta_f$$

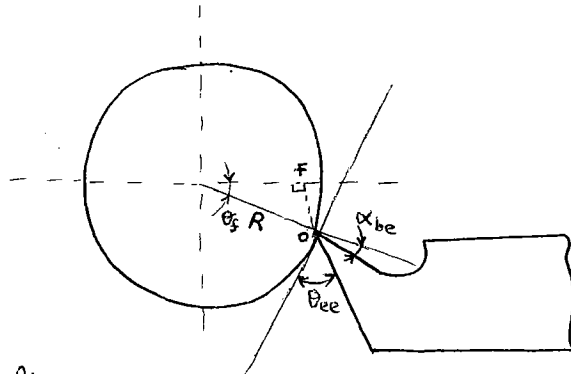

When the tool is set below centre line

- ① Effective rake angle will be reduced. Due to this - forces \uparrow , power consumption \uparrow
tool wear \uparrow , tool life \downarrow
tool become blunt very fast.

- ② The effective relief angle \uparrow
Rubbing action b/w tool and chip will be completely avoided.

Effect of setting tool above the centreline in case of Internal Turning Operation

Boring operation remains same as that of setting tool below centre line in external turning operation and vice versa.

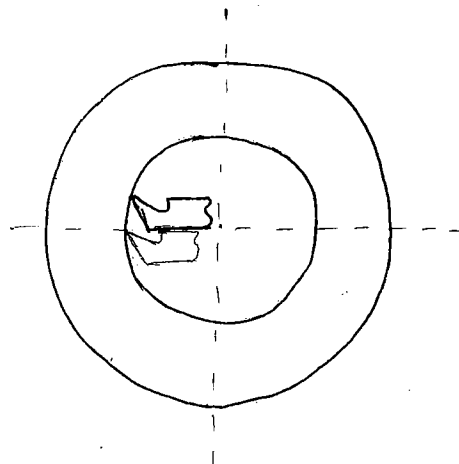

Basic parameters required for analysing the given machining operation as Orthogonal

- 1) α = Rake angle
- 2) t_1 = uncut chip
- 3) b = width of cut
- 4) F_c = cutting force
- 5) F_T = Thrust force

If f and d are given assume $t_1 = f$
 $b = d$

If d and w are given assume $t_1 = d$
 $b = w$

If f and w are given assume $t_1 = f$
 $b = w$

only 2 parameters out of 3 would be given at a time in any question.

Oblique Machining Operation

Since there is no direct methods available for analysis of direct oblique machining, the oblique machining problem can be converted into orthogonal machining problem and analyse it as orthogonal machining problem.

When converting oblique into orthogonal; the above 5 parameters are to be determined.

1) Shaping and planing

It's a single point cutting tool oblique machining operation.

Conversion to single point cutting tool orthogonal \Rightarrow $\alpha = \alpha_b$ (ASA)
 $= \alpha$ (ORS)

$$t_1 = f \cos \lambda = f \sin C_s$$

$$b = \frac{d}{\cos \lambda} = \frac{d}{\sin C_s}$$

F_c = largest force

$$\left. \begin{aligned} F_a = \text{next largest} &= F_T \cos \lambda \Rightarrow F_T = \frac{F_a}{\cos \lambda} \\ F_s = \text{least force} &= F_T \sin \lambda \Rightarrow F_T = \frac{F_s}{\sin \lambda} \end{aligned} \right\} F_T \text{ is obtained by any of the above equation.}$$

$$\begin{aligned} \text{MRR} &= t_1 b v_c \\ &= f d v_c \end{aligned}$$

② Turning and boring

Also single point cutting tool - oblique machining operation and is to be converted to single point cutting tool orthogonal system

$$\alpha = \alpha_b \text{ (ASA)}$$

$$= \alpha \text{ (ORS)}$$

$$t_1 = f \cos C_s = f \sin \lambda$$

$$b = \frac{d}{\cos C_s} = \frac{d}{\sin \lambda}$$

$$F_c = \text{largest}$$

$$F_a = \text{Next largest} = F_T \cos C_s \Rightarrow F_T = \frac{F_a}{\cos C_s}$$

$$F_r = \text{Smallest} = F_T \sin C_s \Rightarrow F_T = \frac{F_r}{\sin C_s}$$

$$\text{MRR} = t_1 b V_c = f d V_c$$

③ Drilling

Multipoint cutting tool - oblique machining operation and is to be converted into single point cutting tool - orthogonal machining operation -

The slot present in drill bit is called - flute

Always in a drill bit

$$\boxed{\text{No. of flutes} = \text{No. of webs}}$$

and it is equal to an even number for balancing of forces acting on the drill bit.

The angle made by flute or web with the horizontal is called helix angle (α_h)

The flutes are provided on drill bit to obtain rake angle of tool tip and facilitate disposal of chip.

For easy on drill bit smaller helix angle will be taken at the centre for making the tool tip strong, and towards the periphery helix angle can be increased and maximum angle at periphery for easy disposal of the chip - variation of helix angle -

This variation is done only at the central portion of the

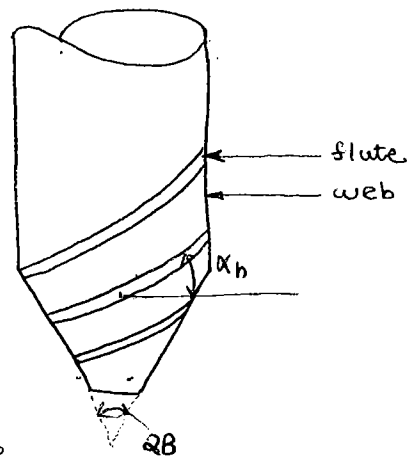

$$\alpha = \alpha_h = \tan^{-1} \left(\frac{1}{2} \frac{\tan \alpha_h}{\sin B} \right)$$

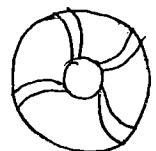

Bez of helix angle variation - the rake angle also varies from minimum at the centre to the maximum at the periphery.

2B - point angle - It's taken as 118° (Standard)

$2B > 118^\circ$ - distressing hard work-piece.

where 2B is less - the conical height \uparrow and there is chance of buckling failure \uparrow when hard w.p is used more force is induced and again the chance increases. Thus $> 118^\circ$

$2B < 118^\circ$ - soft w.p.
= $45-50^\circ$ - Very soft w.p.

During machining of very soft w.p. the type of chips produced is continuous, to dispose them easily; the helix angle must be as maximum as possible. for this the conical length of drill bit must be large. so to get this smaller point angles must be used.

Anyway during machining of soft w.p. forces \downarrow so chances of buckling failure is very less. So less angles could be used.

$$z_1 = \frac{f}{2} \sin B$$

$$b = \frac{D}{2 \sin B}$$

$$\text{Total thrust force} = 5 F_T \sin B$$

$$F_T = \frac{\text{Total thrust force}}{5 \sin B}$$

$$\text{Torque} = 0.6 F_c D$$

$$F_c = \frac{\text{Torque}}{0.6 \times D}$$

$$\text{MRR} = z_1 b v_c$$

$$= \frac{f d v_c}{u}$$

manufacturing by twisting operation
So called twist drill bit.

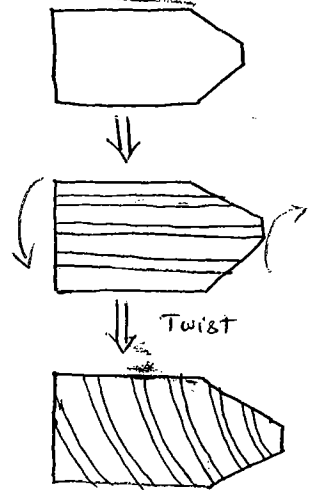

* The twisted portion is join to straight or shank pos by using friction welding operation.

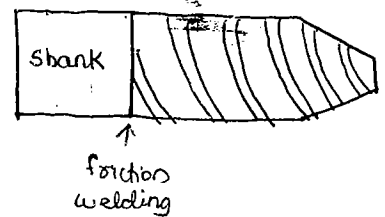

Though drilling is an oblique machining operation it's not possible to measure the 3 component of forces. But the measurable quantities are; The total thrust force acting on drill bit and Torque req to rotate the drill bit.

-9-11

-9 am

Milling:-

It is a multipoint cutting tool - oblique machining

It is to be converted to single point cutting - orthogonal machining

α - rake angle.

If many number of single point cutting tools are mounted along the circumference of a circular disc, the milling cutter will be formed.

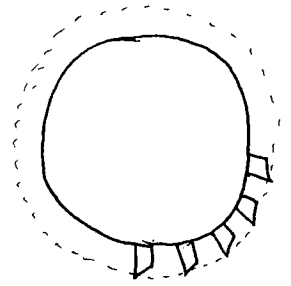

The uncut chip thickness will be varying from a minimum to maximum.

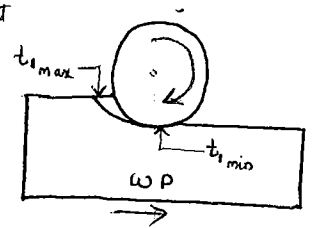

$$t_{1, \min} = 0$$

$$t_{1, \max} = \frac{2 \cdot f_m}{N_t} \sqrt{\frac{d}{D}}$$

$$t_{1, \max} = 2 \cdot f_z \sqrt{\frac{d}{D}}$$

d - depth of cut

f_m - table feed mm/min

$$= FN = f_z \cdot z \cdot N$$

f = table feed mm/rev

f_z = table feed mm/tooth

z = No of teeth

N = rpm

D - dia of milling cutter

b - width of cut

$$z_1 = \frac{z_{1, \min} + z_{1, \max}}{2}$$

$$b = \min(\text{width of cutter, width of WP})$$

In milling 3 components of forces are measurable out of which largest force is taken as f_c , f_a the next largest and f_s the smallest

f_c - largest force

$$f_a - \text{Next largest} = F_T \cos \lambda \Rightarrow F_T = \frac{f_a}{\cos \lambda}$$

$$f_s - \text{Smallest} = F_T \sin \lambda \Rightarrow F_T = \frac{f_s}{\sin \lambda}$$

use any one eqn and find F_T

$$MRR = z_1 \cdot b \cdot f_m$$

always use the table feed in mm/min

Don't use V_c - since one tool is performing cutting action only upto a certain angle.

Cutting Tool Material :-

Properties

- ① Hardness of cutting tool material must be atleast 30-50% higher than the work piece material.
- ② Hot hardness temp. of tool material should be as high as possible
- ③ It should have higher toughness to withstand impact load.
- ④ Thermal conductivity should be as high as possible to distribute the heat without producing high heat concentration.
- ⑤ Coefficient of thermal expansion should be as low as possible to avoid variation of dimensions of components.
- ⑥ Coefficient of friction on the surfaces should be as low as possible.
- ⑦ Easier in fabrication and cheaper.

High Carbon Steel

Hardness = Rc 65.

Carbon content = 0.6 - 2.11

Hot hardness temp = 250°C

Manufacturing method = Forging - To obtain directional stability.
Also forged tools are regrindable.
So total body of the tool is made by using same material, so that whenever the tool is failing it can be resharpened by grinding.

Toughness = Very high
(highest - No cutting tool material is having greater toughness than HCS)

Maximum cutting velocity, $V_c = 5 \text{ m/min}$

speed \uparrow Power \uparrow heat generated \uparrow tool life \downarrow

Applications:-

- 1 Used for machining of very soft W.P materials like Al, Cu, Ag, brass etc
- 2 After HCS, many ^{cutting tool} higher materials have been introduced & developed but still today HCS is been used for manufacturing of chisels bcz of high toughness.

② High speed steel or High alloy steel

Composition = 18 - 4 - 1

W/mo C₁ V → increase wear resistance & maintain sharpness.
 → increase the strength or resistance to deformation
 → Tungsten or Mo is added to increase the hot hardness temp of tool material.

Total alloying elements

< 5%	low alloy steel
5 - 10%	medium alloy steel
> 10%	high alloy steel

If 18% W is used in HSS - it is called - Tungsten based HSS

If 18% Mo is used - it is called - Molybdenum based HSS.

Even Mo is cheaper than W - Tungsten based HSS is been used commonly bcz it's having high wear resistance as compared to Mo.

Hot hardness temp = 600°C

Toughness < HCS

Manufacturing method = Forging - So entire body of tool made of same material in order to enable regrinding.

V_{c max} = 40-50 m/min - nearly 10% greater than HCS
 ∴ name 'high speed steel' and it became popular than High alloy steel.

Applications:-

- It's a general purpose cutting tool material used for making single point cutting tool in - lathe, shaping
 multipoint cutting tools in - milling, drilling etc.

Limitation

Bcz of presence of 76% Fe in HSS. During machining of high carbon workpieces - the carbon atoms will be diffusing from the workpiece and depositing on the tool forming as a built up edge.
 Hence HSS should not be used for machining of High carbon workpieces.

3 Stellite or Non-ferrous cast Alloy

Cobalt - 40-50%

Chromium - 27-32%

Tungsten - 15-25%

Carbon - 2-4%

Manufacturing method = Casting

(So name cast alloy)
 Casting components are ~~not~~ also regroundable
 so total body is made of same material.

hot hardness temp = 800°C

All other properties remain same as the HSS

Stellite is developed as a substitute cutting tool material for machining high carbon wp. in place of HSS.

4 Carbides or Tungsten Carbides or Cemented Carbide or Sintered Carbide.

W is the major constituent

Manufacturing method - powder metallurgy

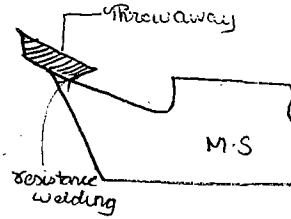

- So it contains very hi hardness and it's not regroundable.

Thus throwaway type of tip of tool is made.

Tip of tool and body is made of diff material.

Hot hardness temp - 1000°C

Toughness < HSS

V_c max = 300-350 m/min

3 type of carbides are there.

P-type carbides - used for machining of steels and ferrous materials

K-type carbides - machining of Cast Iron, non-ferrous metals, non-metal

M-type carbides - General purpose.

also each one is sub divided into P₁₀ P₂₀ P₃₀ P₄₀ P₅₀

K₁₀ K₂₀ K₃₀ K₄₀ K₅₀

M₁₀ M₂₀ M₃₀ M₄₀ M₅₀

lower the number indicates higher the hardness and brittleness of the tool material and higher number indicates - higher ductility and toughness.

lower number tools - finish machining operations

larger number tools - Rough machining operations

5 Ceramics

Major constituent is Aluminum Oxide (Al_2O_3)

Manufacturing Method - Powder metallurgy
throw away type of tool.

Hot hardness temp - $1200^\circ C$

V_c max - 400-500 m/min

It gives excellent surface finish on the rake face of the tool.

Coeff. of friction b/w
chip-tool interface - low

Toughness - Very low
[highly brittle material] - It's been only used for
continuous machining applications
like turning, drilling etc.

6 Ceramics + Metals = Ceramets

Ceramics 90% Metals 10%

Bcz Ceramics is the major constituent element; the properties of ceramets is almost same as ceramics and bcz of addition of 10% metals; the toughness of ceramets is higher than ceramics. Hence ceramets can be used for intermittent machining also.

same as ceramic

hot hardness - $1200^\circ C$
manufacture - Powder Metallurgy

$V_{cmax} = 400-500 \text{ m/min}$

7 Diamond

major constituent is Carbon.

Manufacturing method - Powder metallurgy/graphitization - throw away type tip of tool

Thermal conductivity - high Coeff. of thermal expansion - low

Toughness - high } bcz of orderly arranged C atoms both are
Hardness - high } high.

hot hardness temp - $2000^\circ C$

V_c max - 1500 to 2000 m/min

Limitations.

① Very costly material

② It is used for machining ferrous and non-ferrous materials.

8 Cubic Boron Nitride (Borazone)

major constituent is boron

manufacturing method - powder metallurgy.

Hot hardness - 2000°C

Vc max - 1500 - 2000 m/min

cost - same as diamond.

only reason:-

CBN could be used as a substitute cutting tool material for machining of ferrous w.p. in place of diamond.

9 UCON

major constituent -

Columbium - 50%

Titanium - 30%

Tungsten - 20%

UCON is rolled into sheets and cut in the form of throwaway type of HP of tool using wirecut EDM.

Qualities of UCON is better than Diamond & CBN

Cost is also higher than Diamond & CBN

So it's not a commercially used cutting tool material.

10 Sialon

Si + Al + O + N

Manufacturing method - powder metallurgy

Qualities and cost both are higher than UCON.

∴ Not used commercially.

* Except toughness almost all other qualities, "hardness, hot hardness, cutting velocity, cost etc are in the increasing order from ① to ⑩

Decreasing order of toughness of cutting tool materials 1-2-3-7-8-9-10-4-6-5

5 ceramic is having least toughness.

6 Cermets

4 Carbide

MS and stainless steel are cheaper

1st consider - V_{cmax} - then go for cheaper - then ferrous or nonferrous -

points to be remembered while solving metal cutting problems

1 check whether orthogonal machining operation is indicated or not.

If indicated - analyse the problem as orthogonal.

If non mentioned - check whether the problem belongs to parting off operation, broaching operation, sawing operation etc.

If so :- the problem can be analysed as orthogonal even not mentioned as orthogonal

- check whether the problem belongs to tool life problem, economics of machining problem, effective rake and relief angles problem.

If so :- Need not worry about oblique ^{or orthogonal} - analyse the problem directly as orthogonal. (parameters are not used)

2 If the problem doesn't belong to the above cases - consider it as an oblique - convert it to orthogonal and analyse

Easying Questions

1. $A_3 = A_8 = 200$ $b = 175$ $V = 10^6 \text{ mm}^3$
 $A_C = A_{\min}$

$$P \cdot T = \frac{\text{Vol}}{A_C \times V_{\max}} = \frac{10^6}{200 \times \sqrt{2 \times 1000 \times 175}} = \underline{\underline{2.67}}$$

2. $P_N = \frac{501 \times 8}{PT} = \frac{501 \times 8}{10 \times 0.5} = 100.2$

3. Flow rate = $A_C \times V_{\max}$

$$V_{\max} = \sqrt{2gh} = \frac{\text{flow rate}}{A_C} = \frac{0.5 \times 10^{-3} \times 10^9}{400}$$

G:R = 1:4:4
 = 1:2:2

$b = 200$
 $b = 250$

4. $\frac{V_{sp}}{V_{tube}} = \left(\frac{M_{sp}}{M_{tube}}\right)^2 = \left(\frac{(V/A_s)_{sp}}{(V/A_s)_c}\right)^2 = \left(\frac{A_{sc}}{A_{sp}}\right)^2$

or $\left(\frac{D}{6}\right)^2 = \left(\frac{D}{a}\right)^2 = \left(\frac{2R}{a}\right)^2 \left[\frac{4 \pi R^3}{3} = a^3\right]$

$= \underline{\underline{1.54}}$

5. Ans A] = 0.767

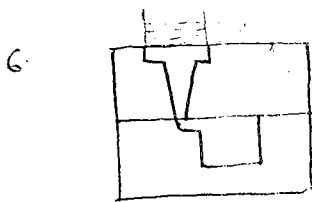

$b = 200 + 50 = 250$

$V_{\max} = \sqrt{2gh}$

$A_C = \min(A_s, A_{notch}) = A_s$

$A_g = 400 \text{ mm}^2 - 2 \text{ part}$
 $A_s = 1 \text{ part} = \frac{400}{2} = 200$

$P \cdot T = \frac{\text{Vol}}{A_C \times V_{\max}} = \frac{\pi/4 \times 150^2 \times 200}{200 \times \sqrt{2gh}} = 8$

dm (c)

7. Ans 'c'

8. C_1 C_2
 Circular disc $d = 20 \text{ cm}$, $t = 10 \text{ cm}$
 Square disc $d = 20 \text{ cm}$

$F \cdot R = X = \frac{(A_s/V)_c}{(A_s/V)_s} = 1.4$ $X_2 = 8$

$Y = \frac{V_s}{V_c} = 0.8$

$Y_2 = ?$

$X \left(\frac{A_s}{V}\right)_s = \frac{(A_s/V)_c}{1.4} =$

Same size on both cases $X_2 = \frac{(A_s/V)_c}{(A_s/V)_s} =$

$V_s = 0.3 V_{c1}$

Same fit in case 2 both cases $Y_2 = \frac{V_s}{V_{c2}} = 0$

Ans. A

9. $V_c = 15 \times 15 \times 15$

$V_s = \frac{65}{1000} V_c =$

$V_s \geq 3 V_{sc}$

$V_s = 3 V_{sc} = \frac{\pi}{4} D^2 H$

Top size

$D = 2H = 11.5$

$H = \frac{D}{2} = 5.75$

$D = 11.5$

check

$\gamma_s \geq \gamma_c$

$m_s \geq m_c$

$\frac{D}{8} \geq \frac{D}{6}$

$\frac{11.8}{6} \geq \frac{15}{6}$ X

So $\gamma_s = \gamma_c$ $m_s = m_c$ $\frac{D}{6} = \frac{D}{6}$

$D = a = 15 \text{ cm}$

10. 6.19 mm 'B'

11. cube = $35 \times 35 \times 35$
 $PT = 45 \text{ sec} = \frac{\text{Vol}}{A_C \times V_{\max}} = \frac{35^3}{\left(\frac{\pi}{4} d^2\right) \times V}$

$V = \frac{35 \times 4}{\pi d^2 \times 45} \rightarrow \text{B}$

$Re \leq 2000$

$Re = 2000 \approx \frac{8 V \rho}{\mu} = \frac{V \rho}{\nu}$ $\theta = C$

$V = \frac{2000 \nu}{d}$ $d = 1.21$

Ans 'c'

12.

$$F = ma = m r \omega^2$$

$$a = \frac{D}{2} (2\pi N)^2$$

$$75g = \frac{D}{2} (2\pi N)^2$$

$$N^2 D = \frac{75g \times 2}{4\pi^2} = \frac{75 \times 9810 \times 2}{4\pi^2}$$

$$= \underline{\underline{37273}} \quad (A)$$

13.

$$D = \frac{D_o + D_i}{2} = \frac{0.52 + 0.5}{2} = 0.51 = \underline{\underline{510 \text{ mm}}}$$

$$N = \sqrt{\frac{37273}{D}} = \sqrt{\frac{37273}{510}} = \underline{\underline{8.5}} \quad (A)$$

14. 0.97 (A)

15. (A)

16. D

17.

18. B

19. D

$$20. \left(\frac{T_c}{T_{sp}} \right) = \left(\frac{m_c}{m_{sp}} \right)^2$$

$$= \left(\frac{A_{ssp}}{A_{sc}} \right)^2 = \left(\frac{4\pi r^2}{6l^2} \right)^2 \left(\frac{m}{l} \right)^2$$

$$= \left(\frac{4\pi}{6} \right)^2 \left(\frac{m}{l} \right)^4$$

21.

$$A_3 V_3 = Q$$

$$V_2 = \frac{Q}{A_2} = \frac{65 \times 10^5}{650}$$

$$V_2 = \sqrt{2gh_2}$$

$$h_2 = -$$

$$h_2 = 200 + h_2 =$$

$$V_3 = \sqrt{2gh_2} =$$

$$A_3 = \frac{Q}{V_3} =$$

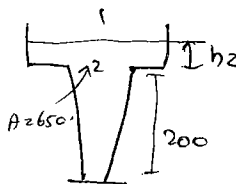

22.

$$\text{Net B.f} = Vg(8-d)$$

$$= \frac{\pi}{4} \times 120^2 \times (80 \times 10^{-3} \times 9.81) \times (11300 - 600)$$

$$= 193.7$$

Ans (C)

23.

$$\left(\frac{D}{L} \right)^2 \quad \text{Ans (D)}$$

24.

$$T_c = K_1 M^2$$

$$= 0.97 \times 10^6 \times \left(\frac{D}{6} \right)^2$$

$$= 0.97 \times 10^6 \times \left(\frac{0.2}{6} \right)^2$$

$$= 1078 \quad \text{Ans (B)}$$

25.

$$L = 137 = 13 \times 10 = 130$$

Ans (B)

26.

D

27.

(A)

28.

(A) - false

(R) - True

29.

4 cm

Ans (B)

H.W

Machine Tool Construction

Lathe

① Bed

② Headstock

③ Tail stock

④ Guide ways

⑤ Functions

⑥ Material

⑦ Mfg. method

⑧ Shape

coated components have higher damping qualities than components.

3-9-11
6-9am

Machining Time:-

In the conventional lathe tool - the best preferable mechanical transmission system is the belt drive bcz any sudden increase in the forces may cause to slip on the belt and nothing will fail.

The number of speed steps taken can be 4-12

So design we decide

D_{min} and D_{max} - D-range

V_{min} and V_{max} - V-range

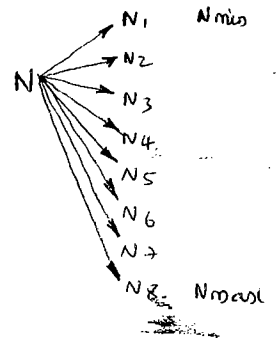

$$N_{min} = \frac{1000 V_{min}}{\pi D_{max}}$$

$$N_{max} = \frac{1000 V_{max}}{\pi D_{min}}$$

N_{min} to N_{max} = Speed range.

$$\text{Speed range ratio} = \frac{V_{max} D_{max}}{V_{min} D_{min}}$$

The speeds (intermediate speeds b/w the N_{min} & N_{max}) is better selected in geometric progression only.

The required rpm or spindle speed may not be available. ^{in machine tool} Thus in this case we would select the nearer spindle speed. Thus a productivity loss may occur.

This productivity loss is minimum if the spindle speeds are designed in G.P.

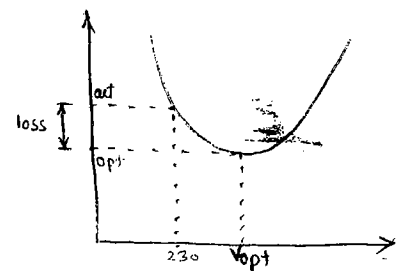

available spindle speed $N = 230$ $N = 2$

optimum is required $N_{opt} = 252$

in this case we select 230 rpm in machine

Q $N_1 = N_{\min} = 34 \text{ rpm}$ $N_6 = N_{\max} = 353 \text{ rpm}$ Calculate the speeds.

$$a_n = a \cdot \delta^{n-1}$$

$$353 = 34 \cdot \delta^{n-1}$$

$$\delta = \sqrt[n]{\frac{N_6}{N_1}}$$

$$= \sqrt[6]{1.596}$$

$$= \underline{\underline{1.6}}$$

$$\frac{353}{74 \times}$$

$$N_1 = 34 \quad N_2 = 8 N_1 \quad N_3 = 54.4$$

* During machining always select the maximum diameter to which the tool is exposed while machining is to be for the calculation of speed or rpm of the machine Tool.

eg:-

Turning

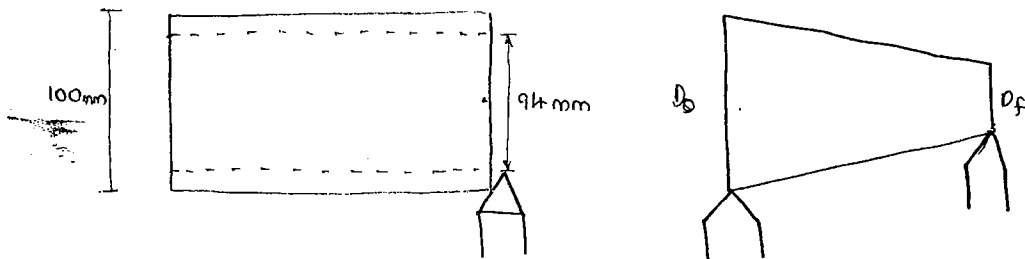

100 mm is taken for calculation

$$N = \frac{1000 V}{\pi (D)}$$

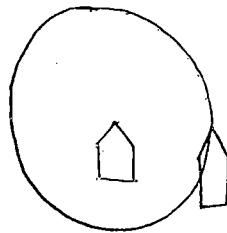

Feed :-

The linear distance travelled by the tool for 1 revolution of the w.p is called feed.

$$f = \text{feed mm/rev}$$

Feed velocity :-

The linear velocity at which the tool is linearly travelling along the w.p

$$fN = \text{feed velocity mm/min}$$

Depth of cut :-

The depth by which the tip of the tool is penetrated into the w.p.

$$d = \text{depth of cut mm}$$

1. Plane turning

The turning operation is used for reducing the dia. of the wp is called plane turning operation.

$$\text{Time per cut} = \frac{L}{\text{Feed Velocity}}$$

$$T = \frac{L}{fN}$$

$$\text{No: of cuts} = \frac{D_0 - D_s}{2d_{\max}}$$

$$\text{Total Time} = T_1 + T_2 + T_3 + T_4 + \dots$$

$$= \frac{L}{fN_1} + \frac{L}{fN_2} + \frac{L}{fN_3} + \frac{L}{fN_4} + \dots$$

$$= L \left[\frac{1}{fN_1} + \frac{1}{fN_2} + \frac{1}{fN_3} + \dots \right]$$

$$= \frac{L}{f} \left[\frac{1}{N_1} + \frac{1}{N_2} + \frac{1}{N_3} + \dots \right]$$

$$= \frac{\pi L}{1000 f V} [D_0 + D_1 + D_2 + D_3 + \dots]$$

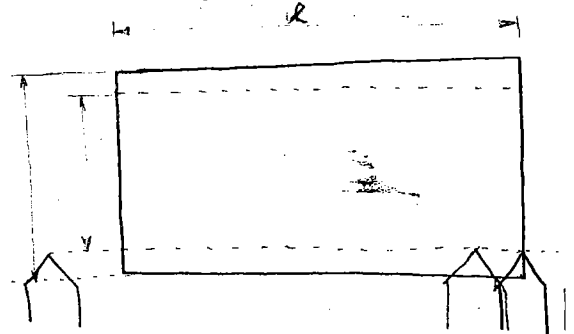

$$L = l + \text{approach} + \text{overrun mm}$$

(only use it if given is estm)

$$f = \text{feed mm/rev}$$

$$N = \frac{1000 V_{\text{opt}}}{\pi D} \quad \text{take } D = D_0$$

$$N_1 = \frac{1000 V}{\pi D_0}$$

$$N_2 = \frac{1000 V}{\pi D_1}$$

⋮

The above method of calculating the total time will be used when the no: of cuts required is ≤ 5 . If the no: of cuts is more than 5 it's very difficult and time consuming. So use the

$$\text{Total Time} = \text{No of cuts} \times T_{\text{avg/cut}}$$

$$T_{\text{avg/cut}} = \frac{L}{f N_{\text{avg}}}$$

2. Face turning

The turning operation used for reducing the length of the component is called face turning operation.

$$t_{\text{time/cut}} = \frac{L}{fN}$$

let $L = 100 \text{ mm}$ $L_s = 92 \text{ mm}$ $d_{\text{max}} = 3 \text{ mm}$

$$\begin{aligned} \text{Number of cuts} &= \frac{L - L_s}{d_{\text{max}}} \\ &= \frac{100 - 92}{3} = \frac{8}{3} \\ &= 2.6 \approx \underline{3} \end{aligned}$$

$$\begin{aligned} \text{Total Time} &= t_{\text{time/cut}} \times \text{No. of cuts} \\ &= \frac{L}{fN} \times \left(\frac{L_0 - L_s}{d_{\text{max}}} \right) \end{aligned}$$

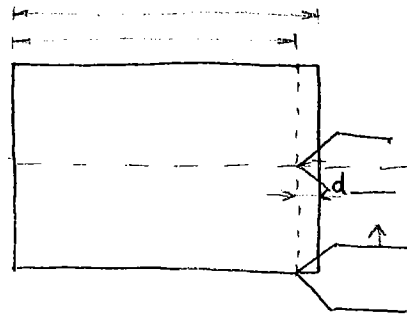

$$L = \frac{D_o}{2} + \text{approach} + \text{overrun} - \text{Solid}$$

$$L = \frac{D_o - D_i}{2} + \text{ap} + \text{OR} - \text{Hollow}$$

$$f = \text{feed mm/rev}$$

$$d = \text{depth of cut mm}$$

$$N = \frac{1000 V}{\pi \times D_o}$$

The turning operation used for producing tapered components in a lathe machine is called taper turning.

$$t_{\text{time per cut}} = \frac{L}{fN}$$

$$\begin{aligned} \text{Total time} &= T_1 + T_2 + T_3 + \dots \\ &= \frac{1}{fN} [l_1 + l_2 + l_3 + \dots] \\ &= d_{\text{max}} \end{aligned}$$

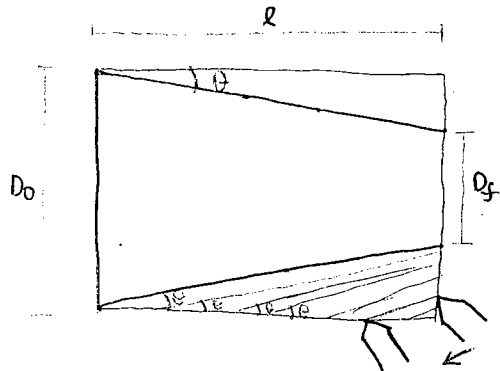

$$L = l_2 + \text{AP} + \text{OR} \quad \theta = \tan^{-1} \left(\frac{D_o - D_f}{2L} \right)$$

$$l_1 = d_{\text{max}} \csc \theta \quad \leftarrow \sin \theta = \frac{d_{\text{max}}}{l_1}$$

$$l_2 = 2 d_{\text{max}} \csc \theta$$

$$l_3 = 3 d_{\text{max}} \csc \theta$$

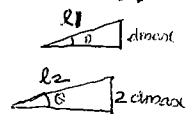

$$N = \frac{1000 V}{\pi D_o} = N_1 = N_2 = N_3$$

Methods of taper turning.

- 1 Compound rest method
- 2 Railstock offset method
- 3 Paper turning attachment
- 4

1 Compound rest method (Compound rest swivelling method)

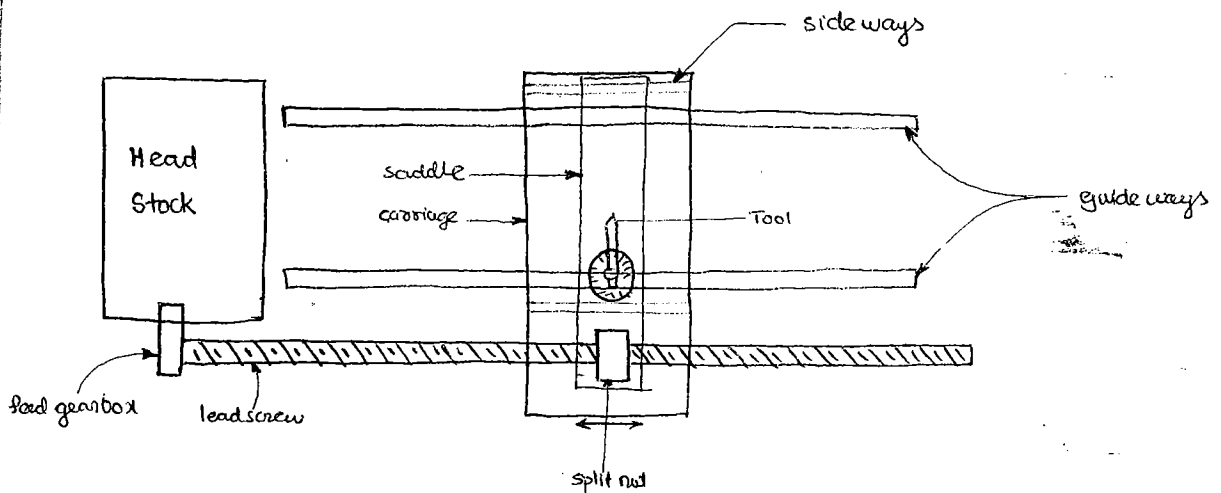

In case of plane turning operation ; '0' of compound rest is coinciding with the fixed mark .

In case of face turning operation ; '90' of compound rest is coinciding with the fixed mark .

In case of taper turning operation ; the compound rest is swivelled by an angle equal to taper angle of the component .

Advantages

1. Used for producing any taper angle from $0-45^\circ$
2. Used for both internal and external taper turning
3. Accuracy of taper angle produced is only upto 0.5° only .

2-Offset method :-

In the normal turning operations the w.p is mounted within the centres with axis of w.p coinciding with axis of machine.

with

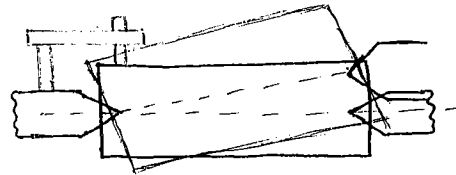

When the w.p axis is tilted, even though the tool is moving like a plane turning operation - taper turning will take place on the work piece.

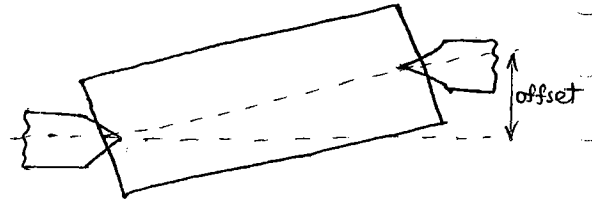

upto 0.1° accuracy tapers could be produce

used only for external taper turning operation.

The maximum offset possible on a standard lathe machine is 10mm

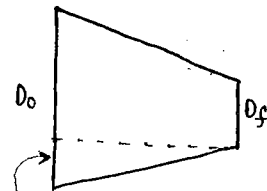

$$\text{Total taper} = \text{offset} = \frac{D_0 - D_f}{2}$$

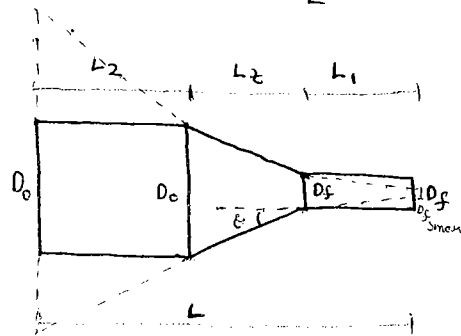

$$\text{Taper/mm} = \left(\frac{D_0 - D_f}{2 L_t} \right)$$

$$\begin{aligned} \text{offset} &= \text{Total taper} = \text{Taper/mm} \times L \\ &= \left(\frac{D_0 - D_f}{2 L_t} \right) \times L \end{aligned}$$

$$\theta = \tan^{-1} \left(\frac{D_0 - D_f}{2 L_t} \right)$$

$$\text{offset} = \text{Total taper} = L \tan \theta$$

$$\text{offset} = \frac{D_{0, \text{big}} - D_{f, \text{small}}}{2}$$

3 Taperturning attachment methodology.

In the normal turning operations; the slide ways would be kept parallel to the guide ways.

In case of taper-turning attachment method; the slideways are tilted by an angle equal to taper angle of the component.

When the slideways are tilted, the saddle, compound rest, tool post and tool will be automatically tilted and perform taper turning operation.

Advantages

Both internal and external taperturning operation.

Accuracy of the taper angle produced is upto 0.1°

Limitations

Upto 8° taper angle or 16° included angle is only possible.

The maximum length of component which can be taper turned in one setting is 235mm only and for longer length of the components; the taper turning will be done in more than 1 setting.

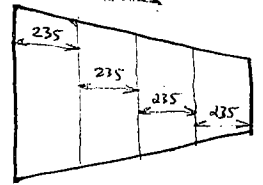

4 Form tool method :-

If the shape of the tool used remains same as the shape of the component to be produced. It is called as formed tool method of taper turning.

It is for producing the tapered component - If the tapered tool is used. It's called form tool method of taper turning.

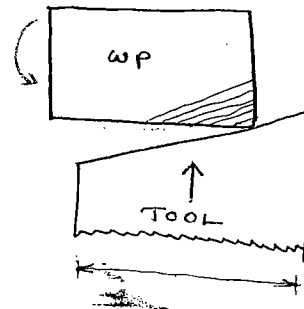

Advantages

Accuracy of the taper produced on the component depends on the accuracy of the taper present on the tool.

No setting is required and it's thus easy to do.

Limitations

Tool cost would be high since for every taper, separate tool is required

Only external taper turning could be performed

For taper turning; the width of the tool must be $>$ length of W.P. to be taper turned. But maximum width of the tool possible is 20mm. Hence maximum length of W.P. which can be taper turned is 20 mm only.

A 200 mm length of the component in which the central 70 mm length of the component is to be tapered to an included angle of 4° . Which of the following methods can be used for doing the job.

(A) Compound Rest method

(B) Tailstock offset method

(C) Paper attachment method

(D) Form tool method

(A) ✓

(B) ✗ ✓

(C) ✓

(D) ✗

$$\text{offset} = 200 \tan 2^\circ$$

$$= 7 \text{ mm} < 10 \text{ mm}$$

$$> 20 \text{ mm}$$

A - B - C

4 Thread Cutting Operation :-

The method of producing threads on is known as thread cutting operation.

using turning operation

$$\text{Time/cut} = \frac{L}{FN}$$

$$L = l + AP + OR$$

S = pitch of the thread - single start

= lead of the thread - multi start

So care of plane, face and taper turning; large amount of feed will be given for rough machining and small amount of feed to finish machine whereas in thread cutting operation, pitch is always fixed.

$$\text{lead} = p \times \text{No of starts}$$

p - pitch.

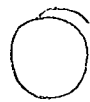

single start



double start



multi start

Multi start threads are used

→ do produce leak proof joint.

→ do get higher mechanical advantage ($MA = \frac{\text{load}}{\text{force}}$)

$$N = 5 - 10 \text{ rpm}$$

A very low rpm is set to enable easy engagement and disengagement

The very low RPM can be obtained by using back gear arrangement. It's also called as reverted gear train.

$$\text{Total time} = \frac{\text{Time/cut}}{\text{No. of cut}}$$

Though the depth of thread is less than max. depth of cut possible in a lathe machine, it is always preferable to perform the thread cutting operation in more than one cut - bcz if thread cutting is done with large depth of cut \rightarrow the thrust force acting will be higher and it may weaken the threads.

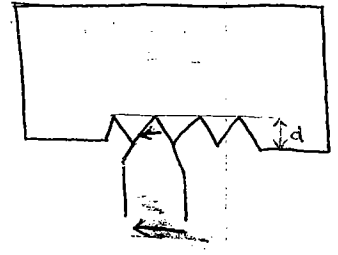

$$\begin{aligned} \text{No of cuts} &= \frac{25}{\text{TPC}} \quad \text{- external} \\ &= \frac{30}{\text{TPC}} \quad \text{- internal} \end{aligned}$$

TPC - Threads per Cm

The earlier turning operations like plane, face and taper turning operations, the feed used is either manual or automatic, depending on the operator. But in case of thread cutting operation, the feed used must be only automatic feed.

Automatic feed required is obtained by using leadscrew and splitnut mechanism.

To get the required amount of pitch or feed it is required to select the proper gears and gear train in the feed gearbox.

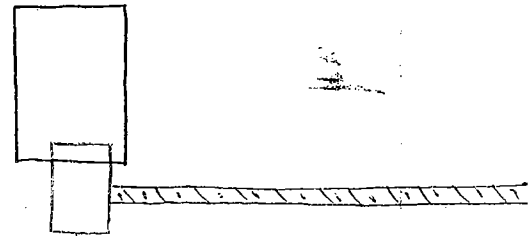

$$\text{Gear ratio} = \text{Train value}$$

$$= \frac{N_s}{N_d} = \frac{N_{L.S.}}{N_{job}}$$

$$= \frac{T_d}{T_f} = \frac{P_{job}}{P_{L.S.}} = \frac{\text{lead of job thread}}{\text{lead of lead screw}}$$

Feed gearbox

Gears of 20-120 teeth
in steps of 5 teeth
and 127 teeth.

"20, 25, 30, ..., 120"
"127"

Indian standard

127 toothed gear is used for producing English threads on a metric lathe or metric threads on English lathe.

If pitch of thread indicated in terms of inches - called as English threads

If pitch of thread indicated in terms of mm or cm - called as Metric threads

If the pitch of leadscrew threads of lathe indicated in terms of inches - English lathe

If the pitch of leadscrew threads of lathe indicated in terms of mm or cm - Metric lathe

Refer the lists on the next pages:



Right hand thread



Left hand thread

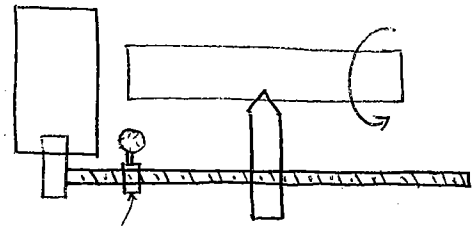

Thread chasing die

for cutting process to take place the w.p should always rotate in ccw when seen through tail stock side.

- all common applications
- lead screw

When bolt is kept stationary and nut is rotated if it goes inside toward right (clockwise) - if it moves inside

only for limited applications

- Jewellery
- O₂ cylinder in gas welding
- turn buckle

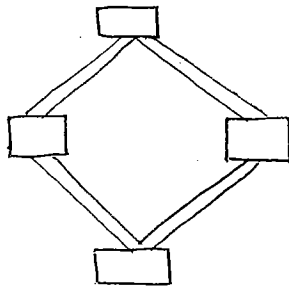
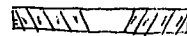

It's simple mechanism used instead of screw jack. It's used for lifting cars. It's lighter than lead screw jack.

- For producing RH threads with the assumption of direction of rotation of job as a counter clockwise direction; the direction of movement of the tool required is right to left direction - for this the direction of rotation of the lead screw required is counter clockwise direction.
- for producing RH threads; the direction of rotation of job and lead screw is same.

to produce the same direction of rotation.

a) If the designed gear train is a simple gear train use 1, 3, 5, ... odd number of idlers.

b) If the designed gear train is a compound gear train use 0, 2, 4, ... even numbers of idlers.

LH - end reverse - ①, ②, ③, ④, ⑤

Q Calculate the gear train to cut 3mm thread on an engine screw machine
 the lathe constant of constant 8, the gear propagation is 4 and
 the gears available 24, 28, 32, ..., 100 and 127.

* Lathe constant = TPI in case of English lathe
 = TPC in case of metric lathe

So 8TPI

$$GR = \frac{Nf}{Nd} = \frac{3 \times \frac{127}{8}}{\frac{1 \times 127}{5}} = \frac{120}{127}$$

$$= \frac{40}{127} \times 3$$

$$= \frac{40}{127} \times \frac{3 \times 24}{24} = \frac{40}{127} \times \frac{72}{24}$$

During thread cutting operation - the path followed by the tool during 2nd and subsequent must remain same as that of the 1st cut itself.

To satisfy the above condition; a thread chasing dial will be used.

It's always engaged with the leadscrew and is having very low rpm.

During thread cutting operation, 1st bring the tool away from the workpiece; set the depth of cut for the 1st cut and engage the lever for the split nut mechanism when selected position of TCD is coinciding with wired mark and continue the thread cutting.

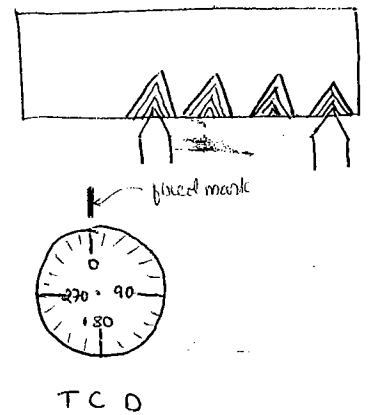

At the end of the 1st cut; disengage the lever of split nut mechanism; take the tool back and bring the tool away from the w.p in front side. Again set the tool for 2nd depth of cut and engage the lever when selected position of TCD is coinciding with fixed mark.

At the end of the length of the threads to be produced, for easy disengagement of the lever; a groove has to be produced - called as grooving or necking or undercutting.

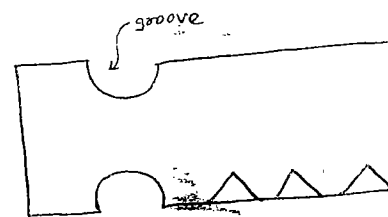

During thread cutting whenever the tool comes to groove zone operator will be feeding certain time for easy disengagement of the lever.

- Q Calculate the suitable geartrains for cutting 10mm ^{pitch} threads with 3 start threads _{on a lathe} with a leadscrew having 6.25mm pitch.

$$G.R = T.V = \frac{N_s}{N_d} = \frac{10 \times 3}{6.25 \times 1} = \frac{30}{6.25}$$

$$= \frac{30 \times 4}{6.25 \times 4}$$

$$= \frac{120}{25}$$

$$\text{If compound geartrains} = \frac{10 \times 4}{6.25 \times 4} \times \frac{3 \times 20}{1 \times 20} = \frac{40}{25} \times \frac{60}{20}$$

For every problem it is possible to design the compound gear train. But simple gear trains could be designed only for few cases.

Make sure that all the gears

- Q Find the change wheels for cutting 1.75mm pitch threads on a lathe of 6TPI leadscrew.

$$G.R = T.V = \frac{N_s}{N_d} = \frac{1.75 \text{ mm}}{\frac{1}{6} \text{ inch}}$$

$$= \frac{1.75}{\frac{1}{6} \times 25.4}$$

$$= \frac{1.75}{\frac{1}{6} \times \frac{127}{5}} = \frac{1.75 \times 30}{127}$$

$$= \frac{52.5}{127}$$

$$= \frac{105}{254}$$

$$= \frac{105}{127} \times \frac{1}{2}$$

$$= \frac{105}{127} \times \frac{1 \times 20}{2 \times 20}$$

$$= \frac{105}{127} \times \frac{20}{40}$$

here simple gear trains are not obtained
here we can produce metric threads on English lathe.

a

1. Bore cutting 2. Repeating 3. Undercutting 4. Plain turning. write these operation in sequence.

In general Bore cutting would be the last operation. and after thread cutting only chamfering is allowed to do it on the component.

Ans: 4-2-3-1

Shaping and Planing

Shaping is the operation used for removing a layer of materials from the w.p using reciprocating single point cutting tool.

1 rev of crank = 1 Forward stroke + 1 return stroke
= 1 double stroke.
= 1 Cutting stroke + 1 ideal stroke

During forward movement of the tool only; the tool is removing material from the work-piece - ∴ called the cutting stroke

During return movement of the tool, it is simply moving without removing any material ∴ called as ideal stroke.

The tool has to travel at optimum cutting velocity during forward or cutting stroke to minimize the production time; the tool has to travel at maximum possible velocity during returning stroke or ideal stroke.

Even though crank is rotating at uniform velocity, to get the variable velocity of the ram; there is a Witworth Quick return mechanism is used b/w the crank and the ram.

Witworth Quick return mechanism is one of the inverses of the simple slider crank mechanism.

through out the movement of the ram; at the middle of the return stroke, the highest velocity will be obtained;

The next highest velocity is obtained at the end of the return stroke

The lowest velocity is obtained at the beginning of the forward stroke

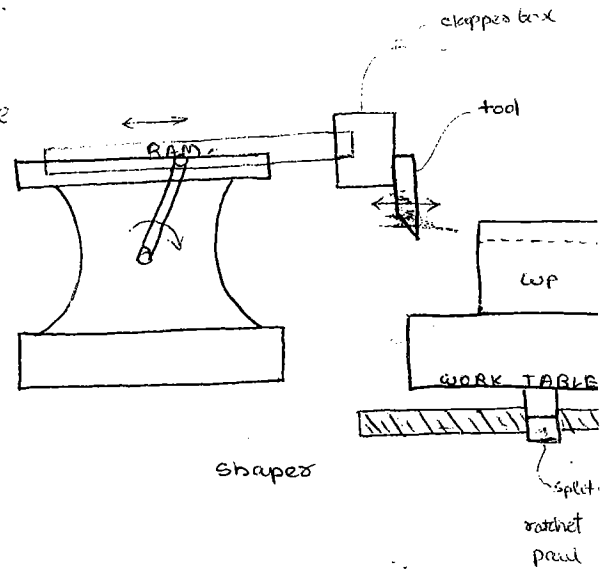

During shaping operation when the tool is moving in the cutting stroke, the tool should be in position for removing the material from the w.p. At the beginning of the return stroke the tool should be lifted upwards to avoid the contact b/w the tool end and the w.p. and again at the beginning of the forward stroke, the tool should take the position for removing the material from the w.p. This will be done by using the clapperbox with rocker arm fitted in front of the ram.

Only automatic intermittent feed will be given bcz the machining also takes place intermittently. Whatever the intermittent feed required for the shaping operation is obtained given to the work table only. bcz the tool is always moving on a fixed guideways.

The intermittent feed required for the work table will be given only during return stroke which is given obtained by using Ratchet and Paul mechanism.

During 1st half revolution of the crank, the lever is moving from right to left direction, the arm is rotating in the clockwise direction with respect to the pivot. During this time the pawl is lifting upwards bcz of presence of inclination at one side of the pawl without disturbing the ratchet and when over it is finally the gap b/w two teeth it is falling down, upwards due to spring force.

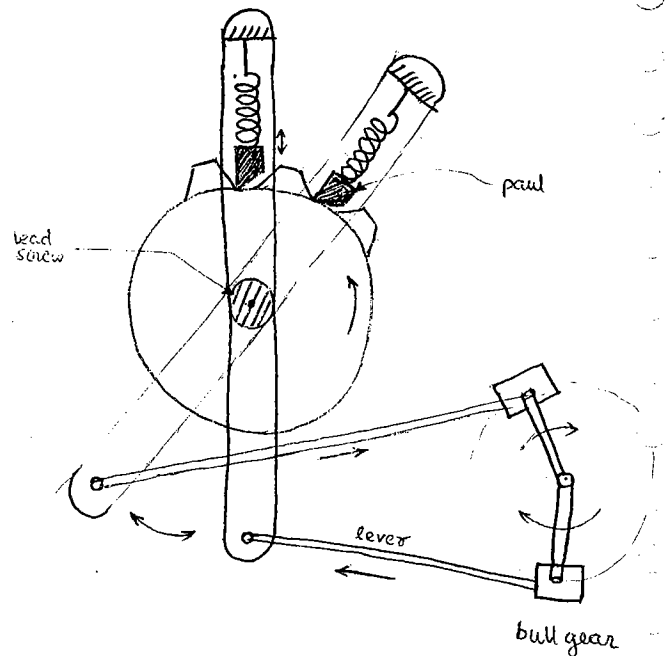

During 2nd half revolution of the crank, the lever is moving from left to right direction, the arm is rotating in counter clockwise direction.

Bcz there is no inclination present on the pawl on the other side, the pawl is rotating the ratchet.

When the ratchet is rotating - the leadscrew is rotating, which moves the split nut - work table, and work piece linearly.

Now by matching the 1st half revolution of the crank with cutting stroke and 2nd half revolution of the crank with return stroke, the feed of the worktable can be obtained only during return stroke.

Ratchet - 20 teeth, Pitch of LS = 5mm. Paul is indexing method by 1 teeth during every Return / double stroke. f (mm/OS) = ?

1 row of ratchet

Let L = stroke length of Rans

V = optimum cutting velocity or velocity of ram during forward or cutting stroke

M = Quick return ratio (< 1) $M = \frac{1}{2} + 0 \frac{2}{3}$

$$= \frac{\text{cutting velocity}}{\text{return stroke velocity}} = \frac{V}{V_r}$$

$$= \frac{\text{time taken for return stroke}}{\text{cutting stroke}} = \frac{T_r}{T_c}$$

B = width of the workpiece

f = feed of the work piece or work table in mm/double stroke.

$$\text{Time taken for cutting stroke} = \frac{L}{V} \quad T_c = \frac{L}{V}$$

$$\text{Time taken for return stroke} = T_c \times M \quad T_r = T_c \times M$$

$$\begin{aligned} \text{Time/OS} &= T_c + T_r \\ &= \frac{L}{V} (1 + M) \end{aligned}$$

$$\frac{1}{\text{Time/OS}} = \frac{V}{L(1+M)}$$

$$\text{OS/time} = \text{RPM of crank} = \frac{V}{L(1+M)}$$

$$\text{Time/cut} = \text{Time/DS} \times \text{No of DS}$$

$$\text{No of DS/cut} = \frac{B}{f}$$

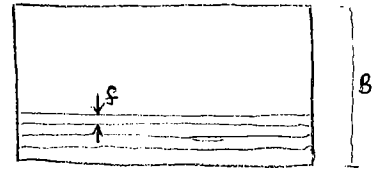

$$\text{Time/cut} = \frac{B}{f} \cdot \frac{L}{V} (1+M) \times \frac{B}{f}$$

$$= \frac{B}{f} \cdot \frac{L}{V} (1+M)$$

$$= \frac{B}{f} \times \frac{1}{\text{RPM of work}}$$

$$B = 2\text{m}, f = 0.1\text{mm}, \text{No of D} = \frac{2000}{0.1} = 20,000$$

$$\text{Time/cut} = \frac{20,000}{10} = 2000 \text{ min}$$

For machining a large WP using shaping machine - the time taken will be very high. To reduce the machining time it is recommended to use more than one cutting tool simultaneously.

To use more than one cutting tool in shaping - more than one ram has to be used. It is nothing but more than one shapers are kept in parallel and it is not economical. Hence when more than one cutting tool is used in machining operation, the tools are fixed on the beam and WP is allowed to reciprocate with optimum cutting velocity in the cutting stroke and maximum velocity in the return stroke. This is called as Planing Machine.

If the shaping machine is rotated by 90° so that the WP is kept vertical and the tool is reciprocating in the vertical axis called as slotting machine.

Drills

6/9/11

6-9

Drilling Operation

Drilling operation is used for producing holes in the w.p.

In general, it is not preferable to produce the required size of the hole by using corresponding size of the drill bit. bcs the forces acting during making the large sized holes directly are very high. These forces causes vibrations in the drill bit end results in poor positional accuracy of the hole produced.

Hence it is always recommended to produce the smallest size of the hole first. i.e the 5mm dia hole and then enlarge the hole by using different sizes of the drill bits like 8, 10, 12, 15, 20.....

Using the above method the maximum size of the tool preferable to produce is 50mm only, beyond which the time taken for producing the hole is large, hence the cost of manufacturing would be high.

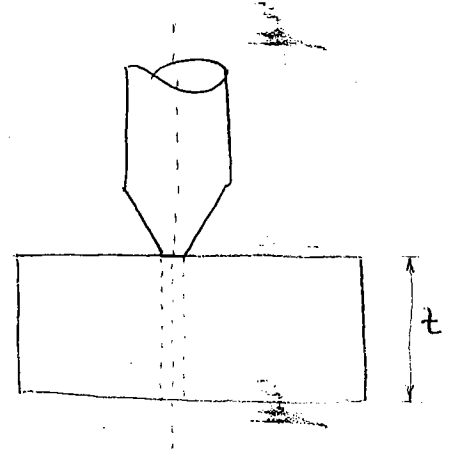

Trepanning Operation

Operation of producing the large sized holes without drilling.

disadvantage

Can be used only for producing 'through holes' but not for blind holes.

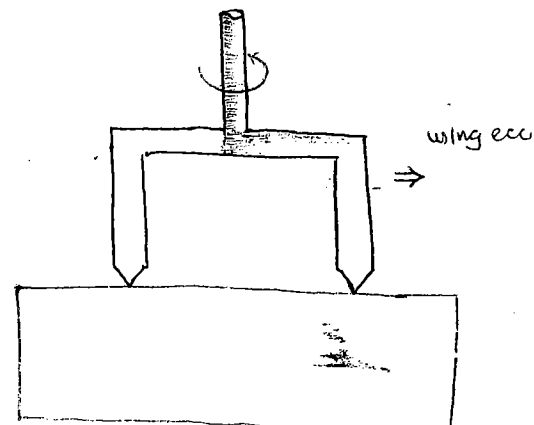
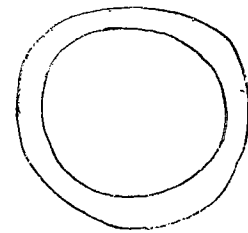
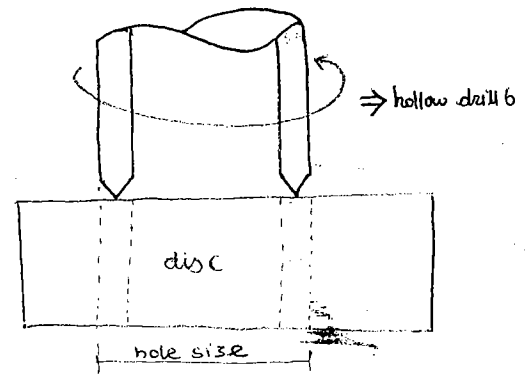

Reaming operation :-

operation used for sizing and finishing of hole.

In this very small sized toothed drill bit can be used so that it removes very small quantities of materials from the w.p.

Boring operation :-

The method of enlarging the existing hole by using internal turning operation.

Counter boring :-

The method of enlarging the end of the hole by using internal turning operation (counter).

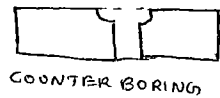

Counter sinking :-

Making the conical enlargement at the end of the hole.

It's been done by using large sized drill bits.



Spot-facing :-

During drilling operation, some of the chips may be left over at the edge of the hole. This will make the improper seating of the bolt head or nut and causes to produce the eccentric loading on the bolt.

To avoid this, the spot facing will be done to make the hole surface perfectly flat and square.

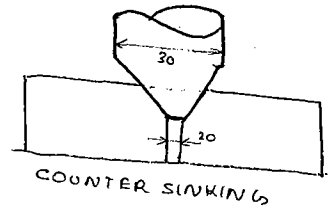

It's been done ^{using} with end mill cutter with drilling machine.

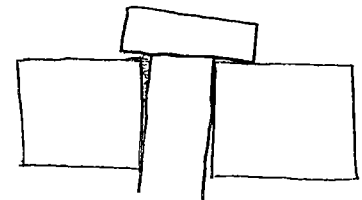

Honing :-

Operation of producing excellent surface finish on holes.

The honing tool, having abrasive coating, rotates and reciprocates inside the already existing hole.

This produces excellent surface finish.

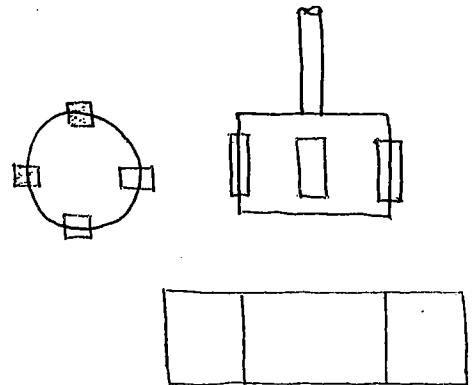

Machining time for drilling

$$\text{Time/hole} = \frac{L}{fN}$$

For the theoretical calculation of machining time in drilling, even though the hole is produced in stages; it is always assumed that the required size of the hole can be produced by using corresponding size of the drill bit directly.

L → length of tool travel

$$L = Z + AP_1 + AP + OR$$

AP_1 - compulsory approach

- distance to be travelled by the tool for complete diameter of the hole has started to produce.

- depth of cut in drilling

0.5 D - through holes

0.3 D - blind holes

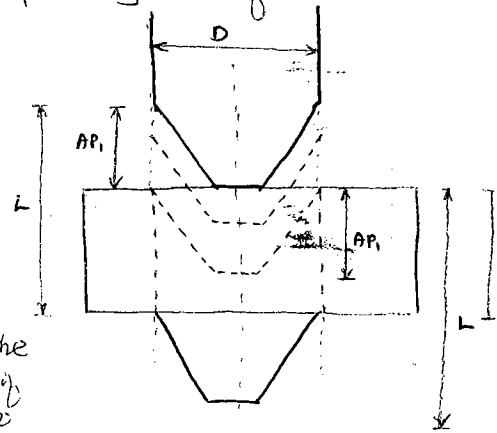

f ⇒ feed mm/rev

$$N = \frac{1000v}{\pi D}$$

D - diameter of drill bit.

MILLING OPERATION

A multipoint cutting tool machining operation used for producing the slots in the component and also used for removing a layer of material from the flat surfaces.

① End mill cutter

② Peripheral milling cutter

If the cutting teeth or tips are provided at the end or face of the circular disc - it is called as end mill cutter.

The end mill cutter can be used either with vertical milling machine or drilling machine also

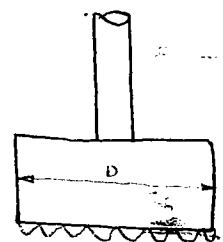

end milling cutter

If the cutting teeth are provided at the periphery of the circular disc - it is called as peripheral milling cutter.

Used only with horizontal milling machine.

Usually they are mounted on a shaft called as arbor - it is having keyways in it and it is expandable shaft.

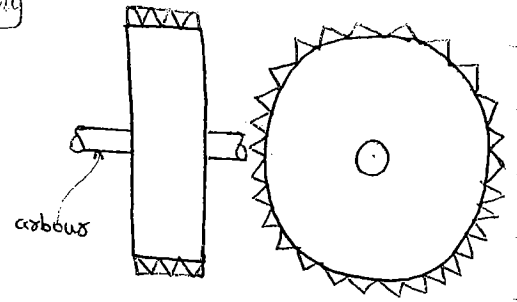

peripheral milling cutter

If a gang of different sizes of peripheral milling cutters are kept together to remove the material simultaneously from one work piece itself - it is called as ganged milling cutter.

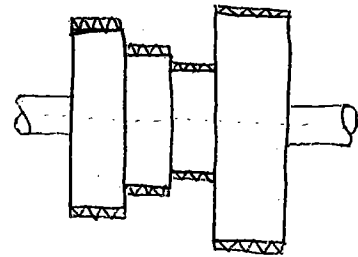

ganged milling cutter -

In addition to the face of a circular disc if the teeth are provided on the periphery also, then it is called as side milling cutter.

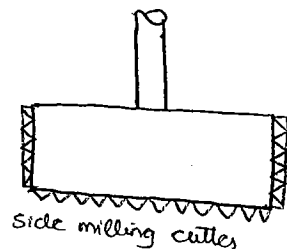

side milling cutter

In addition to the periphery - if the teeth are also provided on the face - it is called as straddle milling cutter.

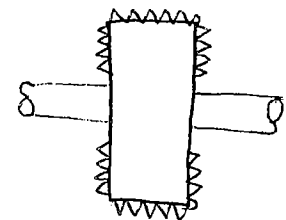

straddle milling cutter.

If the peripheral milling cutter is made like a gear teeth profile to be produced - called as the gear milling cutter or form milling cutter.

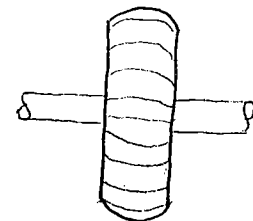

Gear milling cutter

Types of milling

- 1 Face milling
- 2 Slab/slot milling

If the milling operation is used for removing a layer of material from the flat surfaces of w.p. Face milling.

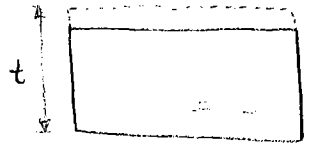

If the milling operation is used for producing the slots in the components - called as slab or slot milling



In general; both the types of milling cutters can be used for performing both the types of milling operations - like facemilling done by using end mill cutter or peripheral milling cutter.

But preferably the face milling operation can be done by using end mill cutter.

and slab milling operation is done by using the peripheral milling cutter.

Machining time for milling

$$t_{\text{Time/cut}} = \frac{L}{S_m} = \frac{L}{fN} = \frac{L}{f}$$

S_m - table feed in mm/min

f - table feed in mm/rev

S_z - table feed in mm/teeth

$$S_m = f \times N = S_z \times z \times N$$

z - no. of teeth

N - RPM of cutter

$$L = l + AP_1$$

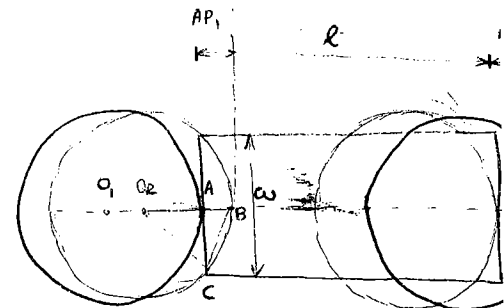

AP_1 - compulsory approach

- distance to be travelled by the tool for complete width of the w.p. in started machining

AP_1

○ face milling with end mill cutter

$$\begin{aligned}AP_1 &= AB \\ &= O_2B - O_2A \\ &= \frac{D}{2} - \sqrt{O_2C^2 - AC^2} \\ &= \frac{D}{2} - \sqrt{\left(\frac{D}{2}\right)^2 - \left(\frac{w}{2}\right)^2}\end{aligned}$$

$$AP_1 = \frac{1}{2} \left(D - \sqrt{D^2 - w^2} \right)$$

D - diameter of milling cutter
 w - width of wp.

During face milling with end milling cutter,
if the axis of the milling cutter is coinciding
with the axis of the wp - symmetrical milling operation.

if the axis are not coinciding called as -
asymmetrical or non-axisymmetric milling.

for asymmetrical

$$\begin{aligned}AP_1 &= AB = O_2B - O_2A \\ &= O_2B - \sqrt{O_2C^2 - AC^2} \\ &= \frac{D}{2} - \sqrt{\left(\frac{D}{2}\right)^2 - \left(\frac{w_i}{2} + OF\right)^2} \\ &= \frac{1}{2} \left(D - \sqrt{D^2 - w_i^2} \right)\end{aligned}$$

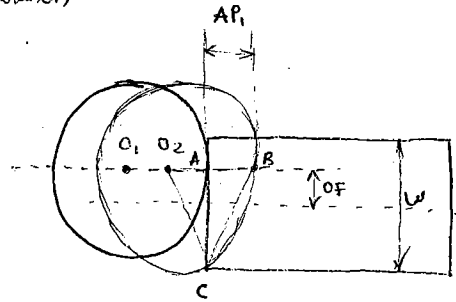

$$w_i = w + 2OF$$

* Approaches AP_1 would be always Δ than the is greater for the
asymmetric milling than symmetric milling. and thus the
time for machining would be greater for asymmetric than symmetric.

* Based on stability symmetrical milling is better than the asymmetric mil-

* most commonly used is the symmetrical milling and asymmetrical
milling is used only when symmetrical milling is not possible.

2. Face milling with peripheral milling cutters.

$$AP_1 = 0.02$$

$$= \sqrt{O_1A^2 - O_2A^2}$$

$$= \sqrt{\left(\frac{D}{2}\right)^2 - (O_2B - AB)^2}$$

$$= \sqrt{\left(\frac{D}{2}\right)^2 - \left(\frac{D}{2} - d\right)^2}$$

$$= \sqrt{Dd - d^2}$$

$$= \sqrt{d(D-d)}$$

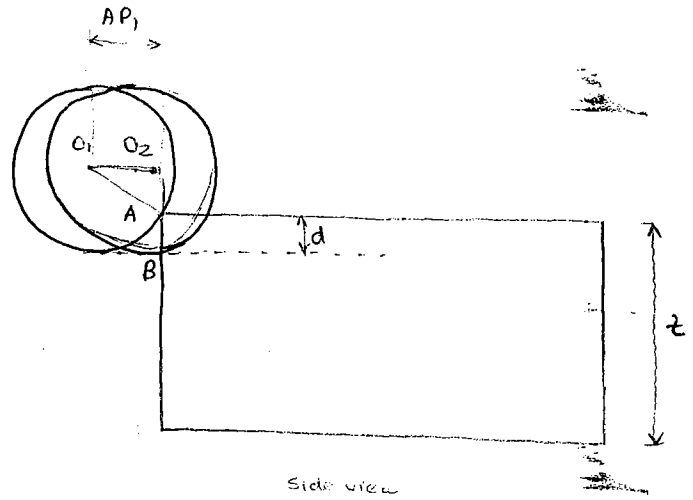

$$AP_1 \approx \sqrt{Dd}$$

3. Slab milling with end milling cutters.

$$AP_1 = \frac{D}{2} \quad [\text{when}]$$

$$= \frac{1}{2} \left[D - \sqrt{D^2 - w^2} \right]$$

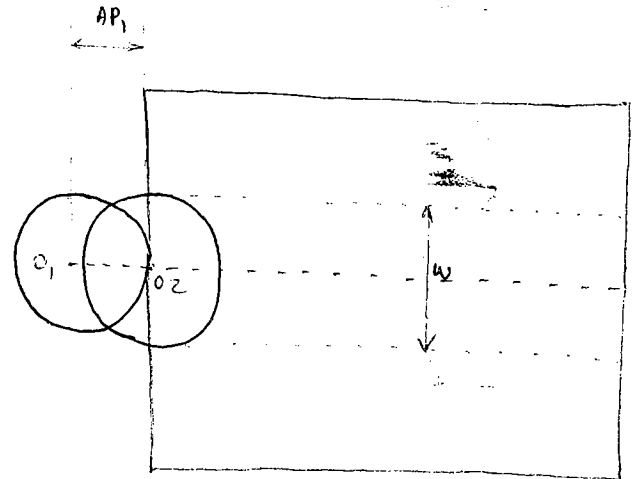

4

$$AP_1 = \sqrt{d(D-d)}$$

same as 2

side view

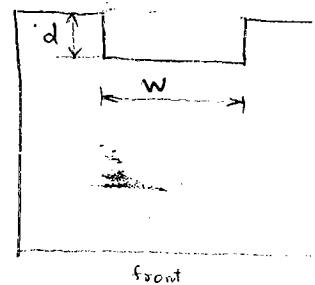

End milling cutter

$$AP_1 = \frac{1}{2} \left[D - \sqrt{D^2 - w^2} \right]$$

Peripheral milling cutter

$$AP_1 = \sqrt{d(D-d)}$$

$$= \sqrt{Dd}$$

When milling is done by using peripheral milling cutters, the milling process can be divided into 2 methods:

① Up or Conventional milling operation.

② Down or climb milling operation.

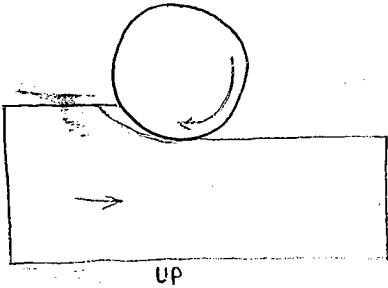

UP

If the direction of movement of the w.p. and direction of rotation of the milling cutter are opposite, called as upmilling operation.

Bez of opposite direction of movement, the forces acting in milling are higher, power consumption is high and tool life is low.

The uncut chip thickness is varying from minimum to maximum to maximum to minimum.

Thus the surface finish would not be so less as compared to downmilling.

advantage

with upmilling bez of direction of movement are opposite, even though backlash is present in the machine gears, there is no fluctuations are produce in w.p. hence as the machine is getting old, it is preferable to use the up milling only.

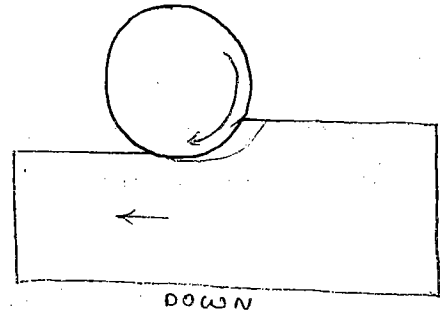

DOWN

If both are moving in the same direction, called as down milling operation.

In case of down milling, bez of same direction of movement, the forces acting are low, power consumption is low, tool wear is low and tool life is high.

The uncut chip thickness is varying from maximum to minimum and

Thus the surface finish produced is better in down milling.

They are commonly used due to less power consumption, less forces, more tool life and greater surface finish.

disadvantage

As the machine is become old, the transmission part experience wear & tear and produces backlash or clearance in the machine gears. This produces fluctuations in the w.p. and causes the mechanical breakage failure of the tool tips or poor surface finish may be taking place.

Indexing of milling

The operation of rotating the job through required angle in b/w the two successive cuts of a machining is called indexing in milling.

$$\begin{aligned}\text{Depth} &= \text{addendum} + \text{dedendum} \\ &= 1\text{m} + 1.25\text{m} \\ &= 2.25\text{m}\end{aligned}$$

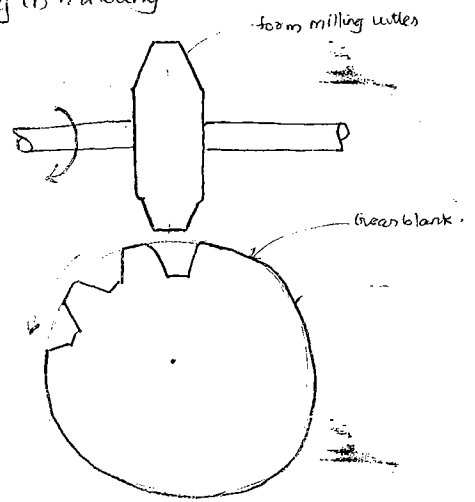

For the indexing to be done mainly 2 devices are required

1. Device - to rotate the job to required angle - crank
2. Device - to ensure that the given rotations are correct - indexing plate
It's a circular disc having holes at various diameters. The angle b/w each consecutive holes at any wheel are same.

2 types of indexing plates are used

(a) Brown and sharp.

3 plates are used

plate 1 - 15, 16, 17, 18, 19, 20 - 6 circles

plate 2 - 21, 23, 27, 29, 31, 33 - 6 circles

plate 3 - 35, 37, 39, 41, 43, 47, 49 - 7 circles

(b) Parkinon

plate 1 - 24, 25, 28, 30, 34, 37, 39, 41, 42, 43

plate 2 - 46, 47, 49, 51, 53, 54, 57, 58, 59, 62, 66.

only Brown and sharp indexing plates are used in Indian standard.

methods of indexing :-

- 1 Direct indexing
- 2 Simple indexing or plain indexing
- 3 Angular indexing
- 4 Compound indexing
- 5 Differential indexing.

①

Work piece and crank is directly connected without any speed reduction.

It has a special indexing plate which has only one side with 24 holes.

The special indexing plate is always fixed.

∴ one revolution of crank give one revolution of the job.

- Be what ever the number by which 24 can be divided without any residue - the corresponding no. of divisions by which the circumference of a job can be divided.

eg:- 2, 3, 4, 6, 8, 12, 24, ...

If No of teeth say $N=4$

crank rotation required after every cut = $\frac{24}{4} = 6$.

we should move 6 holes after every cut.

If $N=5 \Rightarrow CR = \frac{24}{5} = 4.8$ X not possible.

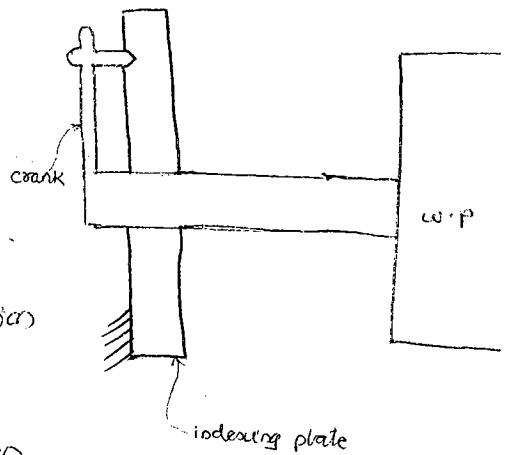

2 Simple or plain indexing:-

for the job and crank - a gearbox is introduced with a gear ratio of 40.

both pinions and brown end shaft is been designed with a gear ratio of 40.

If we can't use another gear set to be should design two gears.

indexing plate (2).

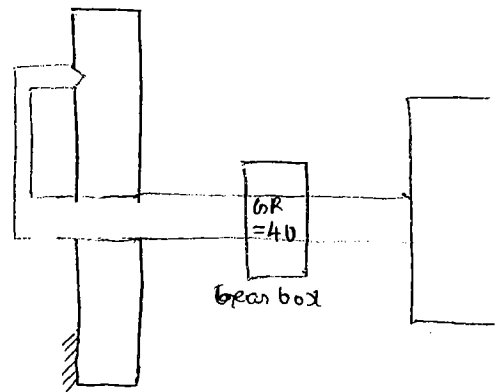

N = No. divisions by which the circumference of a job is to be divided.

$$\text{Crank rotation required} = \frac{40}{N}$$

If $N=24$

$$\text{Crank rotation req. CR} = \frac{40}{24} = 1 \frac{2}{3}$$

$$= 1 \frac{2 \times 5}{3 \times 5} \Rightarrow 1 \frac{10}{15}$$

so after 1 cut then rotate by 1 revolution and 10 holes in a 15 hole circle.

$$\text{If } N = 36$$

$$C.R = \frac{40}{36} = 1 \frac{4}{36} = \text{or } 1 \frac{1}{9}$$

$$= 1 \frac{1 \times 3}{9 \times 3} \rightarrow \text{2 also possible}$$

$$= 1 \frac{3}{27}$$

1 rev + 3 holes in 27 hole circle

$$N = 13$$

$$C.R = \frac{40}{13} = 3 \frac{1}{13} = 3 \frac{3}{39}$$

3 rev + 3 holes in 39 hole circle.

③

$$\text{If we give 1 rev of crank} = \frac{1}{40} \text{ rev of job}$$

$$= \frac{360}{40} = 9^\circ \text{ of job.}$$

θ = angle b/w two consecutive divisions.

$$\text{If } N = 24$$

$$\theta = \frac{360}{24} = 15$$

$$C.R = \frac{\theta}{9} = \frac{15}{9} = 1 \frac{6}{9}$$

$$= 1 \frac{2}{3}$$

$$= 1 \frac{10}{15}$$

Same as that of simple indexing
bc only the method is different

Limitation of simple indexing

Whatever the upto 40 divisions; any no. of divisions are possible; to divide the circumference of the job. But beyond 40 only some numbers are possible and others are not possible

$$\text{If } N = 46$$

$$C.R = \frac{40}{46} = \frac{20}{23}$$

$$\text{If } N = 53$$

$$C.R = \frac{40}{53}$$

53 not available in index plate
53 not divisions also

1/11
9am

Compound Indexing :-

In simple indexing - the indexing plate is always fixed and only crank is rotated to rotate the job. But in case of compound indexing, either plate or crank can be rotated to rotate the job with a gear ratio 40 i.e. only one is rotated at a time.

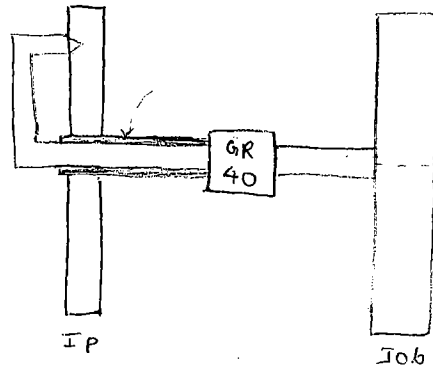

$$C.R = \frac{40}{N}$$

N - No of div by which the circumference is to be divided.

In this method, the required crank rotation is first divided into two fractions, one fraction of rotation can be obtained by fixing the plate and rotating the crank; the other fraction of rotation can be obtained by fixing the crank and rotating the plate.

With this compound indexing, it is possible to divide the circumference of a job into any no. of divisions.

of $N = 27$

$$\begin{aligned} C.R &= \frac{40}{27} = \frac{2}{3} + \frac{22}{27} \\ &= \frac{2 \times 5}{3 \times 5} + \frac{22}{27} \\ &= \frac{10}{15} + \frac{22}{27} \end{aligned}$$

After every cut, by fixing the plate the crank can be rotated through 10 holes in a 15 holes circle and by fixing the crank, the plate can be rotated through 22 holes in 27 holes circle.

One major difficulty of compound indexing is that it is very difficult to divide the required crank rotation into two fractions and even after division also it is necessary to ensure that the hole circles required for both the fractions must be available in one plate itself.

5) Differential indexing:

N - No of divisions

n - number slightly greater or smaller than N

$$CR = \frac{40}{n}$$

The difference from required is

$$\text{diff} = \frac{40}{N} - \frac{40}{n}$$

Bez the n is used for calculation of crank rotation; the difference in crank rotation can be given to the indexing plate simultaneously through externally mounted gear train to the indexing plate. So that whenever the crank is rotating, the indexing plate is also rotating simultaneously either in the same direction or in the opposite direction.

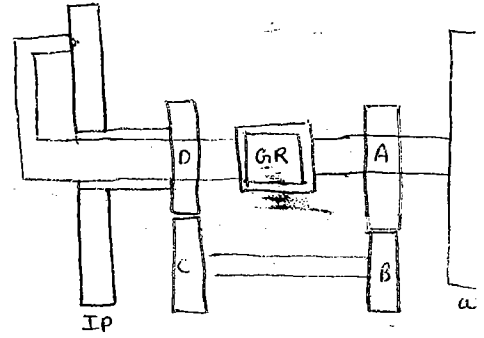

Gear ratio for the gear train is

$$G.R \text{ or } G.T = \frac{(n-N) 40}{n} \Rightarrow \begin{array}{l} +ve - \text{same direction} \\ -ve - \text{opposite direction} \end{array}$$

direction of rotation of crank & indexing plate opposite

let $N = 53$

$n = 55$

$$C.R = \frac{40}{55} = \frac{8}{11} = \frac{8 \times 3}{11 \times 3} = \frac{24}{33}$$

$$G.R = \frac{n-N}{1} \times \frac{40}{n} = \frac{55-53}{55} \times 40 = \frac{16}{11} = \frac{16 \times 2}{11 \times 2} = \frac{32}{22}$$

$$= \frac{8}{11} \times \frac{2}{11} = \left(\frac{8 \times 5}{11 \times 5}\right) \times \left(\frac{2 \times 20}{11 \times 20}\right) = \frac{40}{55} \times \frac{40}{20}$$

let $N = 53$

$n = 50$

$$C.R = \frac{40}{50} = \frac{4}{5} \times \frac{3}{3} = \frac{12}{15}$$

$$G.T = \frac{(50-53)40}{50} = -3 \times \frac{4}{5} = \frac{-12 \times 5}{5 \times 5} = \frac{-60}{25}$$

$$= \frac{-4}{5} \times \frac{5}{5} \times \frac{3 \times 20}{1 \times 20} = \frac{-20}{25} \times \frac{60}{20}$$

we could select any number as 'n' but it is would be easier to calculate if n is a multiple of 5.

It's a slightly costly method.

GRINDING OPERATION

It's a conventional finish machining operation
(tool is harder than w.p)

Gives better surface finish than other methods

Many abrasive particles are present in surface of the grinding wheel act as a single point cutting tool for removing the material from the w.p.

As the machining is taking place, the abrasive particles are slowly wearing out; Once the wear becomes considerable, the abrasive particle is start ~~to~~ rubbing on the work piece so that the rubbing forces produced will pull out the blunt abrasive particles, the fresh and new abrasive particles present behind the blunt abrasive particles are coming in contact with the w.p and start removing the material, called as self sharpening of the grinding wheel.

The approximate shape of the abrasive particles is cubical or square cross section with rectangle.

Therefore the chip produced will have a tetragonal cross section.

Out of all the conventional methods - Grinding is the one which requires highest specific cutting energy bcz:

- of the random orientation of the abrasive particles

Due to random orientation - only about $\frac{1}{3}$ of the abrasive particles are acting like a single point cutting tool and remaining are simply rubbing onto the w.p without doing any machining

∴ the fractional energy losses are higher and specific cutting energy requirements are higher

- Even though the abrasive particles have a capability to penetrate more into the w.p and remove large size of the chip, but the bonding material present b/w the abrasive particles is not allowing the abrasive particles to penetrate more to the w.p. Hence the chip size is reducing and sp cutting energy is increasing.
(due to reduction in rubbing action) or size effect of chip produced

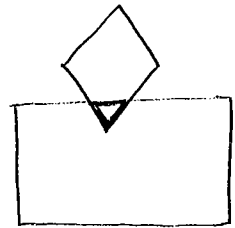
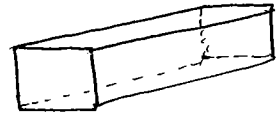
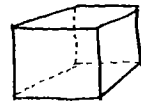
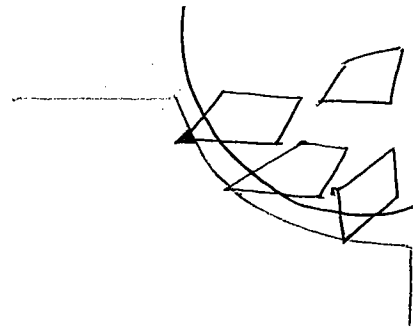

randomly oriented bcz the grinding wheel is manufactured using powder metallurgy

procedure

- ① powdering
- ② Blending
- ③ Compacting → Random orientation
- ④ Sintering

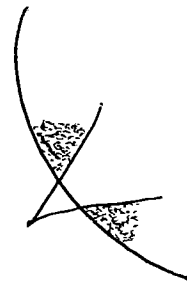

$$\text{Machining ratio} = \frac{\text{Vol. of material removed in W.P.}}{\text{Vol. of tool wear}}$$

In case of turning or milling if the value of machining ratio would be very very large (if 1m^3 removed tool wear by 1mm^3 then $MR = 10^3$). Thus it is having less significance and are not taken in those machining operation.

The machining ratio for the grinding operation is called as grinding ratio. It varies from 0.4 - 100.

$$\text{Grinding ratio} = \frac{\text{Vol. of material removed in W.P.}}{\text{Vol. of wheel wear}}$$

$$\text{Vol. of wheel wear} = \frac{\pi}{4} (D_e^2 - D_s^2) \times w$$

$$\text{Vol. of M.R. of W.P.} = L \times B \times d$$

$$t_{\text{Time/cut}} = \frac{L}{fN}$$

$$V_{c \text{ max}} = 18,000 - 30,000 \text{ m/min}$$

(for diamond cutting
tool we are using
only 1500 - 2000 r/min)

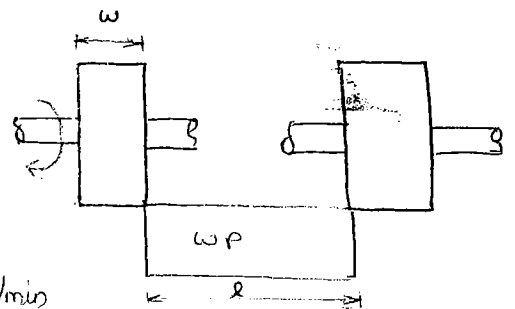

$$L = l + w + AP + OR$$

$$f = \text{feed in mm/rev}$$

$$N = \text{RPM of grinding wheel}$$

$$= \frac{1000V}{\pi D}$$

This much velocity is required to get the metal removal.

Specification of Grinding wheel:

specified by 5 standard codes

A-H - soft grade
I-P - medium grade
Q-Z - Hard grade

③ Grade of Grinding wheel

④ Types of abrasive

A - Al_2O_3 B - B_4C C - SiC D - diamond

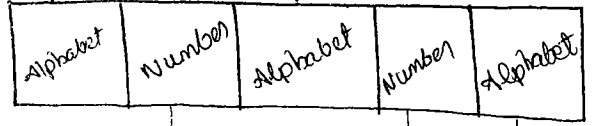

10-24 - coarse
30-60 - medium
70-180 - fine
220-600 - very fine

② Grain size

④ Structure

0-7 - close
8-16 - open

⑤ Bonding material

V - vitrified
B - Bakelite or
S - Silicate
E - Shellac
R - Rubber

① Type of abrasive

Indicates the material used for manufacturing of abrasive particles

Out of the four abrasive particles - diamond is very costly and B_4C is giving poor performance in the machining - hence Al_2O_3 and SiC are the most commonly used

Abrasive particle:

Al_2O_3 is softer and tougher than SiC whereas SiC is hard and brittle than Al_2O_3

The type of abrasive is selected based on the mechanical properties of work material.

Soft and ductile work can be machined by Al_2O_3

and hard & brittle work can be machined by SiC

② Grain size or grit size

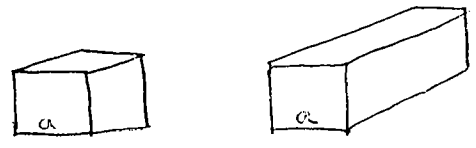

$$a = \left(\frac{1}{G\&S\&N} \right) \text{ inches}$$

reciprocal of grain size no. indicates the size of the side of the cubical abrasive particles in inches.

when GSN \uparrow grain size \downarrow

When the material grain size \uparrow - the material removal rate 1^{st} increases and then decreases.

Grain size is selected based on the surface finish requirements on the w.p.
For finish grinding operation - fine or very fine can be used.
For rough grinding operation - coarse or medium grain size is used.

③ Grade of a Grinding wheel

The grade indicates the hardness of grinding wheel. If for same abrasive particles, same size of the abrasive particles and same bonding material; it is possible to vary the grade of a grinding wheel.

By varying the compacting pressure applied in the compacting stage of a powder metallurgical process used during manufacturing of grinding wheels.

By varying the compacting pressure actually we are varying the green compact strength or green strength of the component.

The grade of a grinding wheel is selected based on the mechanical properties of w.p material.

Hard w.p \longrightarrow soft grinding wheels
Soft w.p \longrightarrow hard grinding wheels

If we use hard grinding wheels to grind hard w.p it results in glazing of grinding wheel.

Because of higher hardness - the forces acting on the abrasive particles is high, the abrasive particles become blunt very fast, i.e. within 1-2 mins. This blunt abrasive particle is start rubbing on to the w.p and produces rubbing forces. But this rubbing forces are not sufficient to pull out the blunt abrasive particles of the grinding wheel is hard. This is called glazed grinding wheel or blunt grinding wheel. This glazed grinding wheel is simply rubbing onto the w.p without doing any machining.

To remove the glazing of grinding wheel dressing is to be done. Dressing is the finishing operation used for removing a thin layer of material from the surface of grinding wheel with diamond wheel or other dressing tools. This operation is used to restore the cutting ability of the grinding wheel.

for hand w.p machining for every 1-2 minutes of grinding operation, nearly 15-20 minutes of dressing time has to be spent which is not preferable.

Hence, if soft wheels are used for grinding of hard work piece materials as and when the abrasive particle is becoming blunt; the rubbing forces produced is more than sufficient to pull out the blunt abrasive particles - hence self sharpening of grinding wheels will take place.

If soft wheels are used for soft w.p material grinding it is not economical as during machining of soft w.p forces induced are lower - hence the abrasive particles can be used for machine of longer durations.

But if soft wheels are used as and when small amount of wear is taking place in the abrasive particle; it is pulled out without effective utilization of the abrasive particle.

If hard wheels are used; the abrasive particles can be used effectively and at the end of effective utilization, the blunt abrasive particles can be removed by dressing. After grinding of 3-5 hours spending 15-20 minutes of dressing operation is very small & negligible.

④ Structure of the grinding wheel

$$\frac{SN}{1000} \text{ inch} = \text{Avg gap b/w the 2 consecutive abrasive particles}$$

The structure is selected based on the mechanical properties of work material and the surface finish requirements of the w.p

Soft w.p → open

hard w.p → closed

Rough grinding → open

finish grinding → closed

Soft wheels → soft w.p

↳ Not economical

↳ No effective utilization of abrasive particles.

hard wheels → soft w.p

↳ effective

↳ 3-5 hrs grinding could be done and only 5-20 mins dressing is req.

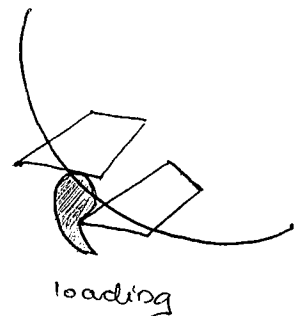

If dense structure is selected for grinding of soft w.p or rough grinding the loading of grinding wheel will be taking place. Loading refers to the clogging of chips in b/w the two abrasive particles.

During machining of soft w.p or rough grinding operation, the size of the chips produced is larger and if the gap b/w the abrasive particles is small, the chip may get clogged in b/w the two abrasive particles.

If open structure is used, b/c of large gap b/w the abrasive particle the chip falls down without clogging.

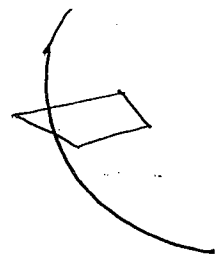

To withstand the large amount of forces acting during grinding of hard w.p.; the abrasive particles must be very close and also for finished grinding the abrasive particles must be very close. Hence dense structure is used. [If it's not close the force would be transmitted to the binding material and they fail]

Rough grinding of soft w.p. — 12 to 16

Rough grinding of hard w.p. — 7, 8, 9

Finish grinding of soft w.p. — 6, 7, 8

Finish grinding of hard w.p. — 3 to 5

5 Bond

The bonding material used for producing bond b/w the abrasive particles is called bond.

The most commonly used bonding material is vitrified bond. b/c it gives higher bonding strength, high temp. withstanding capability and high thermal conductivity.

Rubber or shellac can be used as a bonding material for producing flexible grinding wheels; also called as buffing wheels.

a Select a grinding wheel for finish grinding of HSS cutting tool.

A - 300 - K - 7 - V
 ↓ ↓
HSS not very hard transition region

a select a grinding wheel for rough grinding of brass w.p.

A - 27 - S - 12 - V

Broaching operation

It's a 2° machining operation used for enlarging the existing hole to circular or non circular hole by pulling or pushing the broaching tool through existing hole.

h - rise per teeth

P - pitch

$$\text{Time for broaching} = \frac{L}{V}$$

$$L = t + L_e + AP + OR$$

L_e - effective length of broach

- Cutting length of broach

V - 0.1 - 0.5 m/min

(very very low cutting velocity)

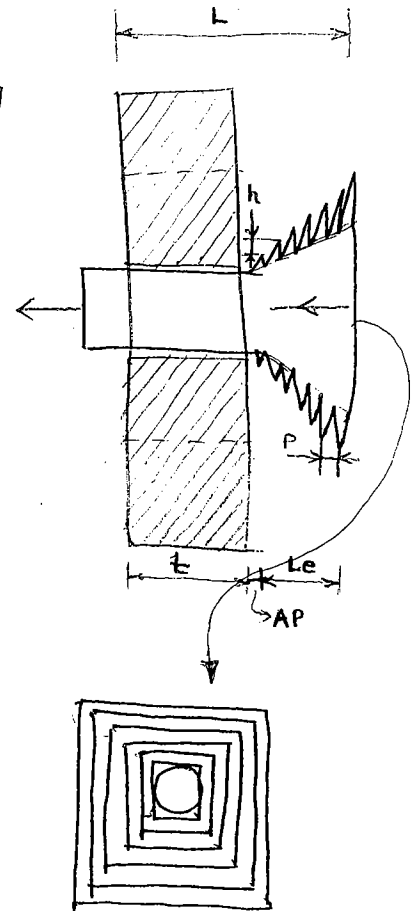

The cutting velocity in broaching is very low bcz when many no. of cutting teeth are in contact with the w.p, the forces acting are very high - hence if cutting velocity is also higher, the power requirement is very high.

Types of teeth :-

① Rough teeth :-

For removing the maximum amount of material from the w.p to change the shape of the component.

The number of rough teeth used is as many as required for machining (no restriction)

② Semi finished teeth :-

Removes a very small amount of material and make the size of the component as required size. The no. of semi-finished teeth used is 4-10.

③ Finish teeth :-

Remove negligible amount of material but making the surface finish good

The number of finish teeth used is 2-6

$$L_e = L_r + L_s + L_f$$

L_r - length of broach for rough teeth

$$= n_r \times \frac{d_r}{P}$$

\downarrow
pitch

n_r - number of rough teeth
 $= \frac{d_r}{h \times n_r}$ - depth of material removed by rough teeth
 h - rise per teeth

$$L_s - n_s \times P_s = \frac{d_s}{h_s} \times P_s$$

$$L_s = n_s \times P_s = \frac{d_s}{h_s} \times P_s$$

depth of material removed

$$d = d_s + d_s + d_s$$

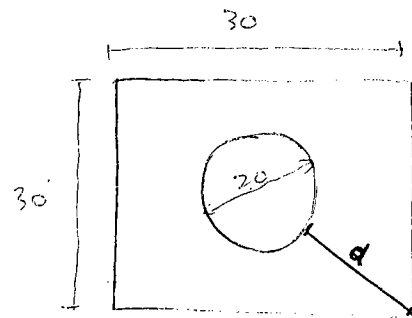

9/11

3-8:00

METAL FORMING PROCESS

Ref:- Metal forming by I. B. Paovali
Metal forming by Nag PAL

In metal forming process, the forces are applied on the material such that the stresses induced is greater than the yield and less than the ultimate so that the material is experiencing plastic or permanent deformation to change the shape to required.

Stresses induced should be greater than yield point but less than ultimate stress.

$$\sigma_y < \sigma < \sigma_u$$

Advantages

- ① No wastage of material
- ② The grain orientation is possible
- ③ Material could be converted from isotropic to anisotropic.
- ④ In certain metal forming process the strength & hardness of the material are increasing.
- ⑤ In some metal forming process, the surface finish produced is better and close dimensional accuracies are also possible.

casted product

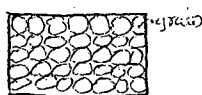

spherical shaped grains uniformly arranged so isotropic property

forged product

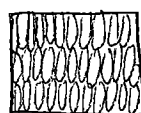

elliptical grains anisotropic

Disadvantages

- ① The force and energy required for the metal forming process is much higher than the other manufacturing process.
- ② Except forging operation all other metal forming process are used for producing uniform cross sectioned components only.
- ③ Components with cross holes cannot be metal formed.
- ④ In some of the metal forming process, the surface finish is poor and poor dimensional accuracies are produced.

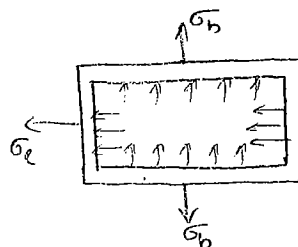

If an internal pressure is applied to a vessel.

2 stresses would be developed - hoop stress σ_b and longitudinal stress σ_e .

In engine cylinder through the applied internal pressure is uniform - $\sigma_b = 2\sigma_e$

Thus if we use isotropic material for manufacture of the IC engine cylinder - then extra material is to be used to withstand σ_b . Thus anisotropic material is preferred in most of engineering application.

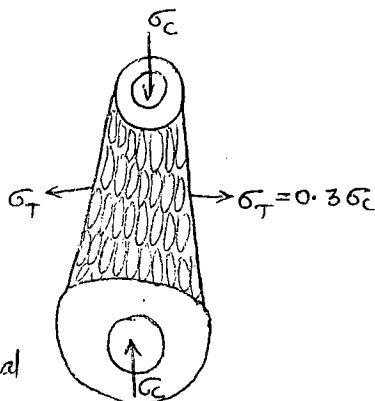

compressive stress in longitudinal direction is σ_c .

Due to poisson's ratio effect, there is a stress in the transverse direction such that

$$\sigma_T = 0.36 \sigma_c = 30\% \text{ of } \sigma_c$$

connecting rod

If made of anisotropic - it will be strong in long-direction & weak in transverse direction. Like that it is better to use anisotropic material.

Metal Forming

Cold working

$$T < RCT$$

Deforming the material; at a temp. less than Recrystallisation temperature is called cold working and deforming the material at a temperature

Hot working

$$T \geq RCT$$

Deforming the material; at a temp greater than or equal to recrystallisation temperature is called hot working.

Recrystallisation temperature is the minimum temperature at which the formation of new crystals has been completed. Whenever the behaviour of the old crystal is completely changed to new behaviour called as new crystal formation or recrystallization. i.e. changing the behaviour means the changing of physical, chemical, mechanical and thermal behaviour.

Whatever the energy required for changing the behaviour of the material is supplied by heating process. When the material is started heating; the grains start absorbing energy. When certain level of energy is absorbed by the grains, they start changing the behaviour called as starting point of recrystallisation. On further supplying the heat energy, at some point when the energy absorbed by the grain is crossing the threshold level of energy, the grains completely forget their old behaviour and shows only new behaviour called as recrystallisation. On further heating the material, the energy supplied will be used for increasing the size of the grains called as grain growth.

Generally

$$RCT = \frac{1}{3} \text{ to } \frac{1}{2} MP$$

RCT of lead and tin are less than the room temperature.

RCT of Zn and cadmium are nearly equal to room temp.

∴ deforming these four materials is done at room temp and are always considered as hotworking operation (since done at temp > RCT)

MP of tungsten is $3400^{\circ}C$ so its $RCT = \frac{1}{3} MP =$

∴ Deforming of tungsten at $1100^{\circ}C$ is still considered as cold working operation

In case of normal material and hotworked material, there is no residual stress are present in the material. ∴ whatever the threshold level of energy required for changing the behaviour of the grains is obtained only through heating process where as in case of cold worked component the internal residual stresses are present in the material. and this also aid in the behaviour

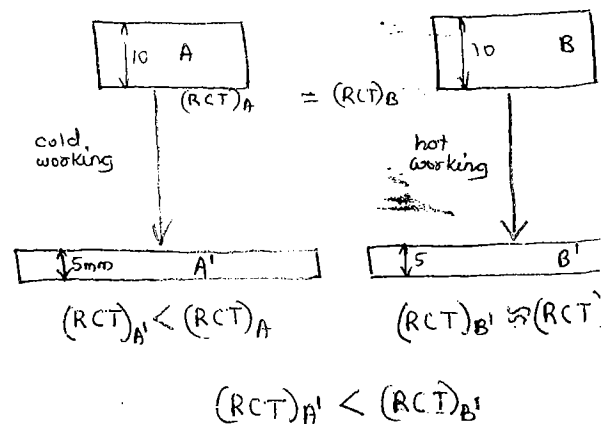

When the cold worked component is heated, whatever the energy available in the energy packets in the form of residual stress is distributed to the surrounding grains. ∴ the required threshold level of energy of grains is obtained through heating as well as distribution of energy available in the energy packets. Hence the grains are attaining required amount of threshold energy at lower temp itself. So $(RCT)_A < (RCT)_B$.

As the amount of cold work on component ↑ RCT of the component ↓

Cold working

For producing same amount of deformation in the material; the force and energy required for cold working is higher than the hot working.

When the material is ^{not} heated to the higher temp; ~~easy~~ [since at high temp is prone to form the oxides; by taking the oxygen from the atmosphere] Due to this ^{no} formation of oxides or scales.

- (a) The surface finish produced would be very poor. excellent.
- (b) ^{close} dimensional accuracies are produced.
- (c) Coefficient of friction produced is ^{high} ~~low~~ 0.5 to 0.6 low, 0.1 - 0.2

Since no heating is done - handling of workpiece is easier.

Always the cold worked component will have higher strength and hardness than the original material bec fine grains are produced.

Hot working

For producing same amount of deformation in the material; the force and energy required for hot working is less.

When the material is heated to higher temp; since at high temp is prone to form the oxides; by taking the oxygen from the atmosphere. Due to formation of oxides or scales.

- (a) The surface finish produced would be very poor.
- (b) Poor dimensional accuracies are produced.
- (c) Coefficient of friction produced is very high i.e. 0.5 to 0.6

Bec of heating of the material, handling of the components is difficult in hot working.

In case of hot working of components; the mechanical properties purely depends on the temp at which the hot working has been completed.

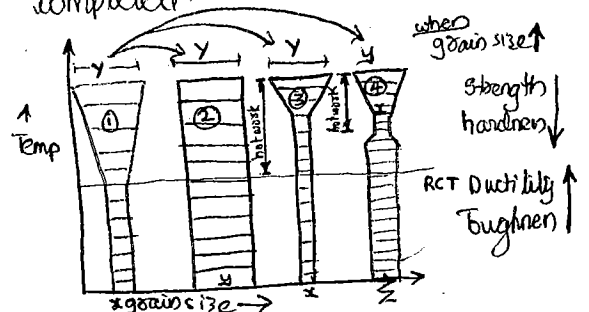

$$z > x$$

(3) whenever the hotworking has been complete very near to the RCT - the grain size obtained remains same as the original grain size and mechanical properties remains same as the original material

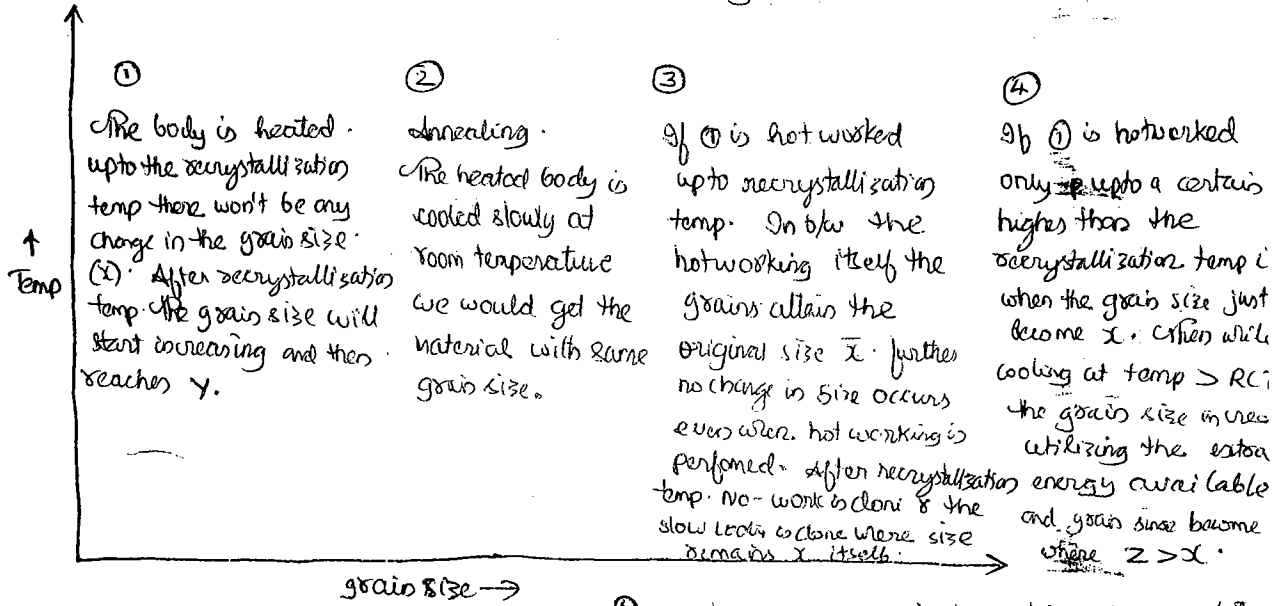

④ whenever the hotworking is completed well above the RCT, the grain size is increased. \therefore the mechanical properties like strength or hardness are higher than the original material. Ductility & Toughness are greater than the original material. Strength & hardness are lower than the original material.

plastic deformation zone

CRZ zone in which material has to be in to perform metal forming process is called plastic deformation zone.

For the given materials and their stress strain diagrams, whichever the material is having widest plastic deformation zone, the corresponding material is considered as a easy to metal forming material.

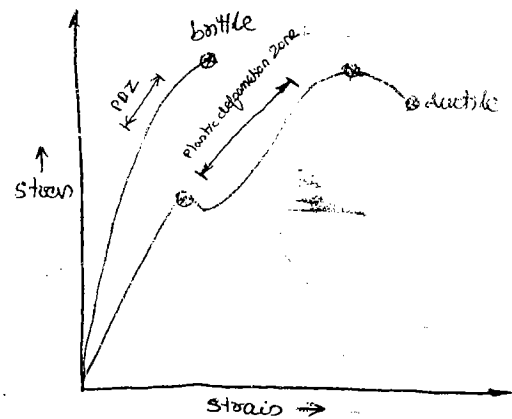

For making the given material as a 'easy to metal forming process' materials; the plastic deformation zone of a given material has to be widened. This is possible by

- (1) Increasing the ultimate strength of the material. This can be done by cold working. But with cold working not only the ultimate strength, the yield strength

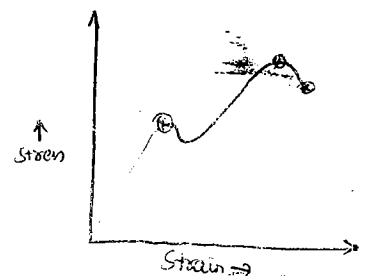

of the material also increases. The width of the plastic deformation zone almost remains constant. Hence it's not a preferable method.

(2) By reducing yield strength of the material

The yield strength of a material can be reduced by heating the material. With heating the small amount of reduction in the ultimate strength of material also reduces but is very small & negligible. Hence the plastic deformation zone is wider. This is a possible and preferable methodology.

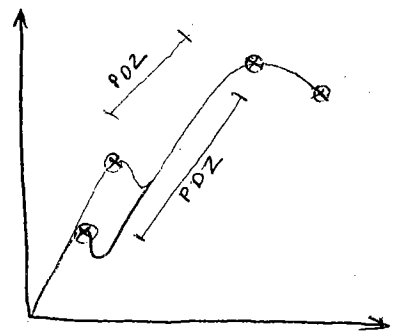

The yield strength of most of the materials will get reduced with increase in temp except steel:

steel

$T < 150^{\circ}\text{C}$; $T \uparrow$ $\sigma_y \downarrow$

$T = 150$ to 350°C $T \uparrow$ $\sigma_y \uparrow$

$T = 350$ - 750°C $T \uparrow$ $\sigma_y \downarrow$

$T = 750$ - 850°C $T \uparrow$ $\sigma_y \uparrow$

$T > 850^{\circ}\text{C}$ $T \uparrow$ $\sigma_y \downarrow$

From this data,

The steel should not be deformed in the temp ranges of 150 - 350°C and 750 - 850°C Bcz in this ranges the yield strength of the steel will be increasing with increase of temp.

1539° - solidification from
BCC

↓

1410° - δ -iron
FCC

↓

910° - α -iron [non-magnetic]
BCC

↓

723° - α -iron (magnetic)
BCC

This is bcz of the allotropic property of iron.

allotropic property is repeatable but polymorphism is not.

TENSILE LOADING

If a total distortion is given that lies within plastic deformation zone and the load is removed; it traces a path as shown - i.e. parallel to that of elastic deformation zone. When ever an elastic defor^s when it was in the plastic deformation zone some reverse elastic deformation occurs and the plastic deformation obtained is less than the total deformation. [Then why? we call it as plastic deformation zone].

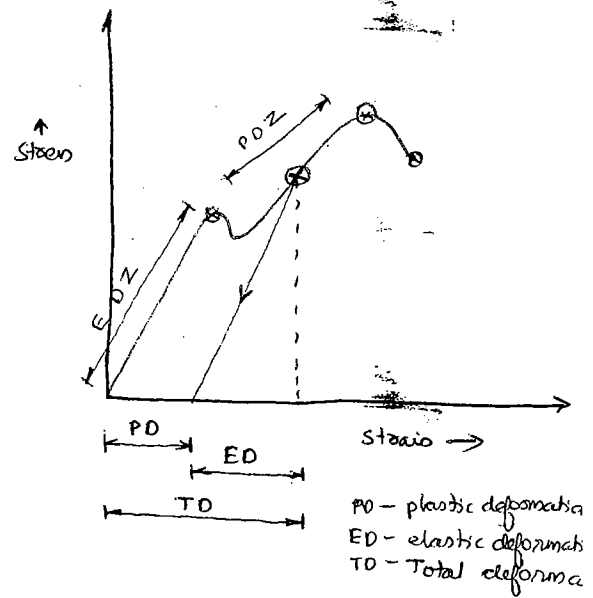

This is b/c instead of removing the load immediately; if we ~~we~~ maintain load for some more time, this ^{elastic} plastic deformation (ED) could be converted to plastic defor^m (PD) i.e. it retraces through the \perp direction. i.e. $PD = TD$.

From the above - whenever the tensile loads are applied in the metal forming process, it is necessary to maintain the load applied for some more time to convert ED present in the PDZ into PD.

Compressive loading

When ever the material is experiencing the σ compressive stress $>$ flow stress, the flow behaviour of the material is like a fluid. \therefore the same called as the flow stress of the material.

Once we are stressing the material to a stress above σ_f ; 100% permanent deformation is obtained. [Once the material is 'flowed' - then permanent deformation is obtained its like the fluid behaviour of it if we pour the liquid from a height - it won't come back with out using any external energy].

So whenever compressive loads are applied in the metal forming process, it is not necessary to maintain the load for some more time. Like in the case of tensile loading condition.

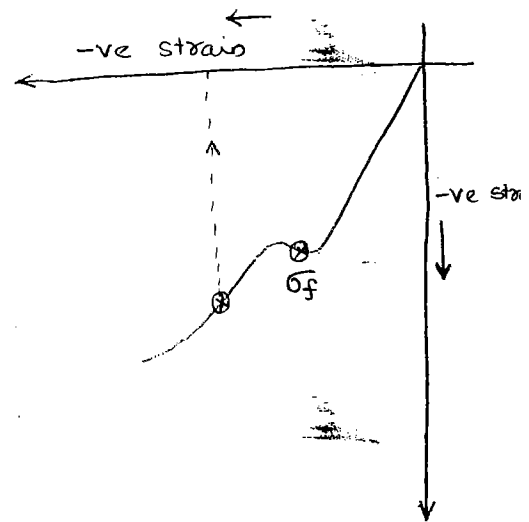

σ_f - flow stress of the material
 $\sigma_f \approx \sigma_y$

Metal forming Methods

① Rolling

② Drawing

③ Extrusion

④ Forging

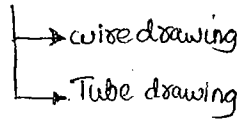

① Rolling

In rolling operation - the compressive forces are applied by using rotating rollers or material is compressed in b/w the two rotating rollers such that the thickness of the sheet can be reduced from H_0 to H_1 .

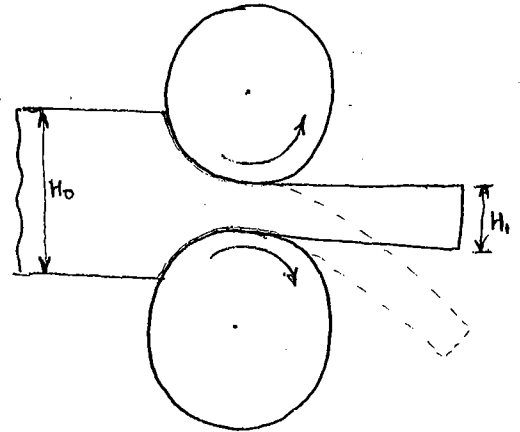

To avoid the bending of the strip, the surface velocity of both the rollers must be same.

$$V_{top\ roller} = V_{bottom\ roller}$$

$$(\pi DN)_{top} = (\pi DN)_{bottom}$$

$$(DN)_{top} = (DN)_{bottom}$$

To maintain the same contact area b/w the rollers and the strip, same diameters of the rollers must be taken.

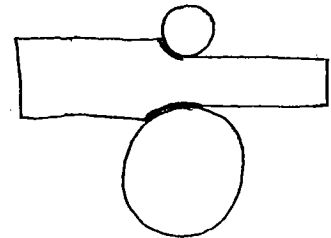

If diameters of rollers is same - the rpm of rollers would also be same - So same prime movers could be used for rotating both of the rollers without any gear box.

Let H_0 and H_1 be thickness of the strip before and after the rolling operation.

Then reduction in strip thickness

$$\Delta H = H_0 - H_1$$

D - diameter of rollers

$R = \frac{D}{2}$ - radius of rollers

V = surface velocity of rollers

V_0, V_1 = velocity of strip before and after rolling operation.

B, b = width of the strip before & after rolling

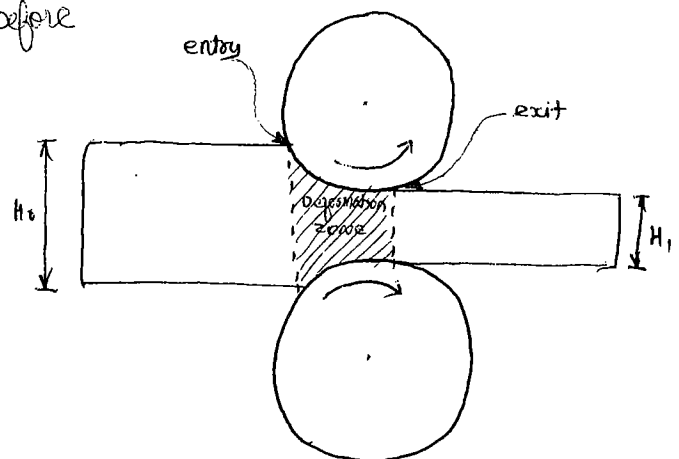

Where ever the strip starts contacting the roller is called entry point.

Where ever the strip starts separating from the roller - exit point

Zone present b/w entry and exit point is called - Deformation zone

Assumption in Rolling

① Every material which is undergoing the metal forming process is considered as incompressible. \Rightarrow i.e. the volumetric changes of the material is taken as '0'.

② The width of the strip during rolling operation remains same.

③ When the thickness of strip is reduced, the volume of the strip is reducing in the thickness direction. Whenever the reduction of volume in the thickness direction has to be increased either in the width direction or in the length direction. But bcz the rollers are rotating, the increase in volume is taking place only in the length direction so that the width of the strip remains constant.

Neutral point

At this point, the stresses induced in the material is just equal to the flow stress of the material. Beyond which the velocity of the strip is further increasing - \therefore at exit strip velocity is greater than the surface velocity of the roller. $V_0 < V < V_1$

In rolling operation, strips will be pulled to the roller bcz of presence of friction on the interface of the rollers and the strips.

Volume before = volume after
 $H_0 \times b_0 \times V_0 = H_1 \times b_1 \times V_1$

$$b_0 = b_1 = b$$

Thus

$$H_0 V_0 = H_1 V_1$$

$$\frac{H_0}{H_1} = \frac{V_1}{V_0}$$

$$V_1 > V_0$$

At the entry the rollers are pulling the strip. \therefore velocity of the rollers must be greater than the velocity of the strip.

\therefore at entry $V_0 < V_1$

Along the deformation zone - the surface velocity of roller is const. But velocity of strip is increasing \therefore at some point the velocity of the strip will be equal to surface velocity of the roller. The corresponding point is neutral point.

deformation angle - is the angle made by the deformation zone with the centre of the roller. It's also called as angle of bite or bite angle (α)

α - bite angle

$$\cos \alpha = \frac{OB}{OA} = \frac{OC - BC}{OA}$$

$$\cos \alpha = \frac{R - \frac{\Delta H}{2}}{R}$$

$$R \cos \alpha = R - \frac{\Delta H}{2}$$

$$\frac{\Delta H}{2} = R - R \cos \alpha$$

$$\Delta H = 2R(1 - \cos \alpha)$$

AC = Arc length of Deformation Zone (DZ)
 $= R\alpha$

AB = length of DZ = L

$$= \sqrt{OA^2 - OB^2}$$

$$= \sqrt{R^2 - (R - \frac{\Delta H}{2})^2}$$

$$= \sqrt{RAH - \frac{\Delta H^2}{4}}$$

$$RAH \gg \gg \gg \frac{\Delta H^2}{4}$$

$$AB = L = \sqrt{RAH}$$

ΔOAB

$$\tan \alpha = \frac{AB}{OB} = \sqrt{\frac{RAH}{R - \frac{\Delta H}{2}}}$$

$$R \gg \gg \gg \frac{\Delta H}{2}$$

$$\tan \alpha = \sqrt{\frac{RAH}{R}}$$

$$\cos \alpha = \sqrt{\frac{AH}{R}}$$

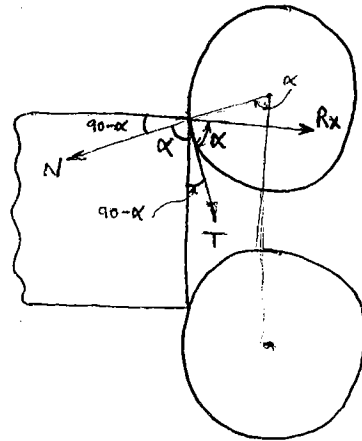
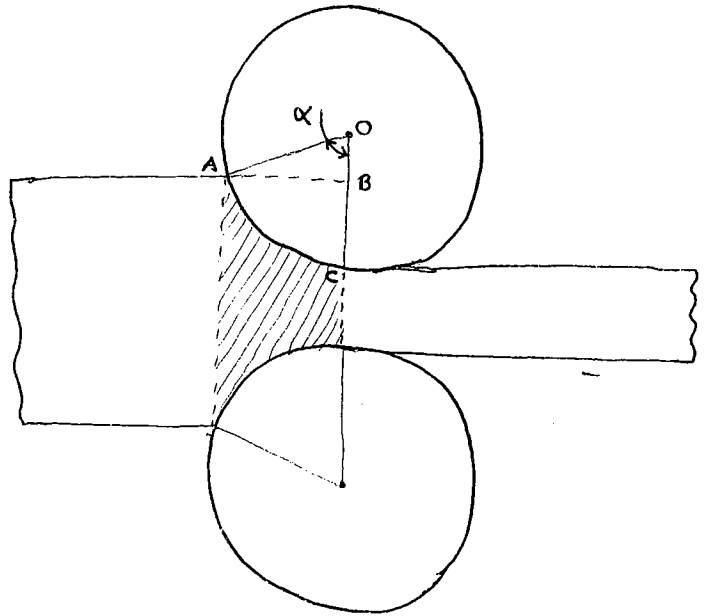

R_x - Resultant resolved horizontal component of frictional force

$$R_x = T \cos \alpha - N \cos(90 - \alpha)$$

$$= T \cos \alpha - N \sin \alpha$$

$$T = \mu N$$

(Tangential force component T is the frictional force)

$$R_x = \mu N (\cos \alpha) - N \sin \alpha$$

$$R_x = N (\mu \cos \alpha - \sin \alpha)$$

$$R_x \geq 0$$

$$N (\mu \cos \alpha - \sin \alpha) \geq 0$$

$$\mu \cos \alpha \geq \sin \alpha$$

$$\mu \geq \tan \alpha \quad \text{if } \beta \text{ is the friction angle}$$

$$\tan \beta \geq \tan \alpha$$

$$\boxed{\beta \geq \alpha}$$

In a given rolling operation, max. angle of the bite must be less than or equal to the friction angle.

$$\text{If } \alpha = \beta, \text{ [Coulomb friction condition]}$$

↳ Reduction occurring is maximum reduction

$$\Delta H = \Delta H_{\max}$$

$$\tan \alpha = \sqrt{\frac{\Delta H}{R}} = \mu (\tan \beta)$$

$$\boxed{\Delta H = \Delta H_{\max} = \mu^2 R}$$

Q $H_0 = 180 \text{ mm}$ $H_f = 95 \text{ mm}$, $D = 650 \text{ mm}$, $\mu = 0.21$ Number of passes = ?

$$\begin{aligned} \text{No. of passes} &= \frac{\Delta H_{\text{total}}}{\Delta H_{\max/\text{pass}}} \\ &= \frac{180 - 95}{\mu^2 R} \\ &= \frac{85}{0.2^2 \times 325} \\ &= 6.7 \approx \underline{\underline{7}} \end{aligned}$$

At the entry the relative velocity b/w the rollers and strips are maximum, as we are moving along the deformation zone, the surface velocity of the rollers remains constant and velocity of the strip will be increasing. ∴ the relative velocity is reducing.

At the neutral point the velocity is equal. ∴ the relative velocity is zero.

Beyond the neutral point, the relative velocity is again increasing and becomes maximum at the exit.

The neutral point divides the deformation zone into two zones i.e. lagging zone and leading zone.

↓
Strip lagged behind the roller

The relative velocity is 1st reducing and then increasing in deformation zone.

where as

The relative velocity is only decreasing in lagging zone and only increasing in leading zone.

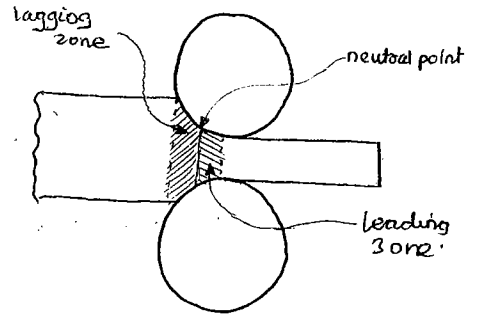

Slip \propto Relative velocity

\therefore Slippage b/w rollers and strip is decreasing 1st and then increasing along the DZ

In lagging zone the slippage is gradually reducing. \therefore max % slip taking place in lagging zone is called backward slip.

$$\text{Backward slip} = \frac{V - V_0}{V} = 1 - \frac{V_0}{V}$$

In leading zone the slippage is increasing continuously. \therefore max % slip taking place in leading zone is called forward slip.

$$\text{Forward slip} = \frac{V_1 - V}{V} = \frac{V_1}{V} - 1$$

Pressure at interface $\propto \frac{1}{\text{slip}}$

At the entry pressure is minimum. Then start increasing and becomes maximum at neutral point and starts reducing and becomes minimum at the exit.

Along the deformation zone - the pressure is increasing 1st and then reducing whereas in lagging zone, the pressure is only increasing and in leading zone the pressure is only reducing.

let $n = \frac{2ML}{\Delta H}$

pressure at any point along the lagging zone

$$(P_x)_{\text{lagging}} = \left(\frac{\sigma_y}{n}\right) \left[(n-1) \left(\frac{H_x}{H_0}\right)^n + 1 \right] - \left(\frac{H_x}{H_0}\right)^n \sigma_1$$

- σ_y - Yield stress or hoop stress
- H_x - thickness of the strip at any point along the lagging zone where the pressure is to be determined
- σ_1 - back tension. (not compulsory - it's an accessory to improve the efficiency of rolling operation)

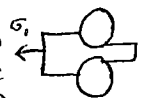

pressure at any point along the leading zone

$$(P_x)_{\text{leading}} = \left(\frac{\sigma_y}{n}\right) \left[(n+1) \left(\frac{H_1}{H_x}\right)^n - 1 \right] - \left(\frac{H_1}{H_x}\right)^n \sigma_2$$

σ_2 - front tension (also an accessory)

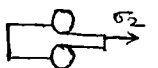

at neutral point

$$(P_n)_{\text{lagging}} = (P_n)_{\text{leading}}$$

(don't consider the eccentricity)

$$\left(\frac{\sigma_y}{2}\right) \left[(n-1) \left(\frac{H_0}{H_n}\right)^2 + 1 \right] = \left(\frac{\sigma_y}{2}\right) \left[(n+1) \left(\frac{H_1}{H_n}\right)^2 - 1 \right] \Rightarrow H_n = ?$$

from diagram \rightarrow Neutral point is near to H_1 but not by a large margin μ (not that much near)

$$H_n = H_1 + 20-30\% \Delta H$$

without working out; just by seeing the options - we could answer.

Q $H_0 = 20$ $\mu = -$ $H_n = ?$
 $H_1 = 14$ $R = -$

- (A) 18.5 (B) 17 (C) 15.4 (D) 14.2

$$\begin{aligned} H_n &= 14 + (0.2-0.3) \times 6 \\ &= 14 + (1.2 \text{ to } 1.8) \\ &= 15.2 \text{ to } 15.8 \end{aligned}$$

Power required for rotating the roller

$$\begin{aligned} P_{\text{total}} &= 2 \times P_{\text{roller}} \\ &= 2 \times T \omega \end{aligned}$$

$$P_{\text{total}} = 2 \times \frac{2\pi NT}{60}$$

$$T = F_{\text{avg}} \times a$$

$$= (P_{\text{avg}} \times \text{Projected area}) a$$

$$= \frac{2}{\sqrt{3}} \sigma_y \left(1 + \frac{\mu L}{4H}\right) \times (b \times L) \times a$$

$$T = \left[\frac{2}{\sqrt{3}} \sigma_y (bL) \left(1 + \frac{\mu L}{4H}\right) \right] \times a$$

$$H = \frac{H_0 + H_1}{2}$$

Avg thickness of strip.

T - torque required to rotate the roller
 ω - angular velocity of the roller

$$\omega = \frac{2\pi N}{60} \quad N - \text{rpm}$$

$$T = \text{Force} \times \text{Radius}$$

force is not uniform. so we should take F_{avg} .

so we can't take R but we take

$$= F_{\text{avg}} \times a$$

a - moment arm

$$a = \pi L$$

$$\pi = \text{asm factor} = 0.3 \text{ to } 0.4$$

L = length of defo zone

$$F_{\text{avg}} = P_{\text{avg}} \times \text{Projected area (AB)}$$

\rightarrow force acting by rollers on strip

During rolling operation equal & opposite reaction force produced by the strip is acting on the rollers for separating the rollers. $\therefore F_{\text{avg}}$ is also called as roll separating force

For reducing the power required for rotating the rollers, mainly the F_{avg} or roll separating force has to be reducing

Methods for reducing F_{avg}

① $\sigma_y \downarrow$

As the power required can be ~~high~~ reduced by heating the material. In general the rolling will be considered as a hotworking operation only

② $\mu \downarrow$

μ could be reduced until α becomes equal to β

③ $R \downarrow$

As the roller radius is reducing $L \downarrow$ and $F_{avg} \downarrow$ but the load bearing capacity of the roller \downarrow and chances of failure of the roller \uparrow

To avoid this backup or supporting rollers should be used.

④ Using σ_1 and σ_2 .

When back and front tensions are applied, it acts like a tensile loads along the length direction of the strip, which induces the compressive stresses in the thickness direction due to Poisson's ratio effect.

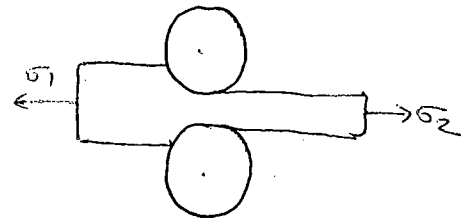

When compressive stresses are induced in thickness direction, the force to be applied by using the rollers for rolling operation to take place is reduced.

preference 1 - 3 - 4 - 2

When roll separating force is acting of the rollers; each and every roller can be considered as a simply supported beam with UDL.

\therefore the roller will be getting deflecting and the gap b/w the rollers is filled by using the material.

\therefore the thickness of the strip in the width direction will become non uniform

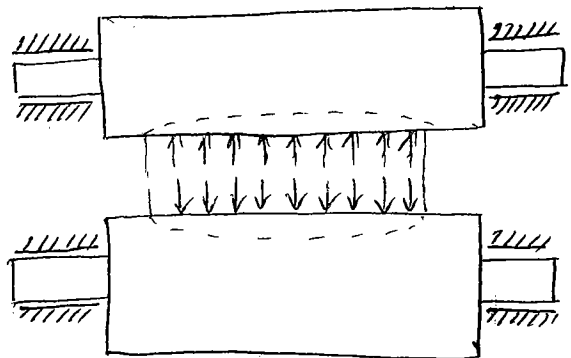

To get the uniform thickness of chip in the width direction; the rollers can be made like a convex roller or cambering of rollers.

Drawing

2/10/11
Sunday

Wire drawing:

The method of producing wires from the solid rods by pulling through a stationary die is called as a wire drawing operation.

Stationary dies are been used.

The wire would be divided to 4 zones

Zone I - deformation zone

Whatever the deformation required for converting the rod into the wire is obtained in this zone. Therefore the name gives as deformation zone.

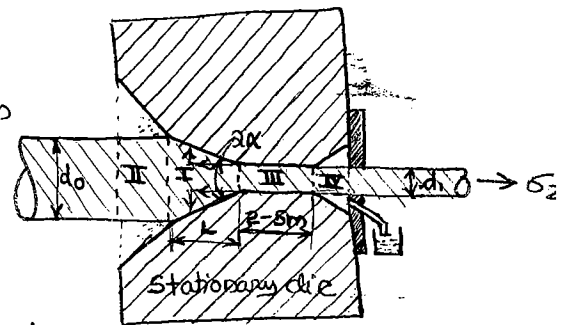

The angle made by the deformation zone (2α) is called die angle or deformation angle. Usually it varies from $12-48^\circ$. 12° is for wire drawing of hard materials and 48° is used for wire drawing of very soft materials.

L = length of deformation zone or die zone die land.

During wire drawing operation - due to the presence of friction at the interface; a backward frictional force will be acting, which is resolved into two components of forces.

(1) Horizontal component of frictional force

It increases the drawing force to be applied on the front side of the drawing process.

(2) Vertical component of frictional force.

It tries to break or fail the die.

To minimize the above effect, the friction at the interface has to be minimized.

This is done by using lubricants in the wire drawing operation.

Zone 2 - Lubricating or entry zone

Whatever the lubricants required for wire drawing operation is supplied from zone 2 only and \therefore called lubricating zone.

Different types of lubricant conditions

① No lubrication condition :-

If no-lubricant is used in the wire drawing operation, the frictional forces at the interface is high, heat generation is high and hence the surface of the wire can be observed as black or burned colour.

② Liquid lubricant :-

If liquid lubricants are used; the friction is reducing & heat generation is reducing \therefore wire surface can be observed as metallic or dull surface.

eg:- liquid lubricants used are mineral oils, vegetable oils, BAE oils, saltso soap solution, kerosene etc.

Kerosene is used for wire drawing of highly reactive metals (Al, Mg etc)

③ Solid powdery lubricants :-

When solid powdery lubricants are used; it is reducing the friction and heat generation and also produces microscopic scratches on the wire surface which makes the surface of the wire appearing to be bright shining or silvery surface.

eg:- Carbon powder, graphite powder, glass powder etc are for
[Non ferrous materials] [ferrous metals]

Zone 3 - Sizing zone

This zone is used for converting the elastic deformation present in the PDZ into plastic deformation.

The length of the sizing zone is normally about 2-5m.

Zone 4 - Exit or safety zone :-

When the lubricants are used in the wire drawing operation, it passes through the interface of the die & wire and experience higher pressure and temperature. When this high pressure and temperature comes out from zone 3, it may get fall to the front side bodies and damage them. To avoid this, a divergent zone called as exit zone is provided which is closed by using a cover; so that when the high pressure lubricants comes into the exit zone, its pressure is reducing and it can be drained out afterwards.

If lubricants are not used in the wire drawing operation, no exit zone is required.

$$A_0 = \frac{\pi}{4} d_0^2 \quad - \quad \text{cross sectional area of rod}$$

$$A_1 = \frac{\pi}{4} d_1^2 \quad - \quad \text{cross sectional area of wire}$$

$$\frac{A_0}{A_1} = k \quad - \quad \text{Draft}$$

- drawing ratio

$$\frac{A_0 - A_1}{A_0} = J \quad - \quad \text{\% reduction in area}$$

$$\mu \quad - \quad \text{Coeff. of friction at interface}$$

$$\text{let } B = \mu \text{ (let } x)$$

$$\sigma_2 = \text{Drawing stress} = \sigma_y \left(\frac{1+B}{B} \right) \left[1 - \left(\frac{A_1}{A_0} \right)^B \right]$$

σ_y - yield stress of material

$$\text{Drawing load or drawing force} = \sigma_2 \times A_1$$

$$\sigma_2 < \sigma_y$$

During calculation of the σ_2 , the horizontal component of frictional force acting in the backward direction is not considered. By considering this horizontal component of frictional force; the total stress to be applied at the front side for drawing operation is called as total drawing stress (σ_T)

bcz we are calculating the stress σ_2 at the exit.

if we calculate the stress in the deformation zone definitely $\sigma > \sigma_y$.

$$\sigma_z = \sigma_y + (\sigma_2 - \sigma_y) e^{\frac{-2\mu L}{R_1}}$$

Total drawing load

$$T.D.L = \sigma_z \times A_1$$

In wire drawing operation; if the drawing stress applied at the front side is equal to the yield stress of the material, the corresponding reduction in the wire drawing operation is considered as maximum possible reduction.

$$i. \sigma_z = \sigma_y$$

$$\frac{\sigma_z}{\sigma_y} = 1 = \left(\frac{1+B}{B}\right) \left[1 - \left(\frac{A_1}{A_0}\right)^B\right]$$

$$\frac{A_1}{A_0} =$$

$$K = \frac{A_0}{A_1}$$

$$J = \frac{A_0 - A_1}{A_0} = 1 - \frac{A_1}{A_0} =$$

$$K_{max} = 2 \text{ to } 6.$$

$$\begin{aligned} \epsilon &= \text{True strain} = \ln(1+e) \\ &= \ln\left(\frac{A_0}{A_1}\right) \end{aligned}$$

e - engineering strain

$\epsilon \times \sigma_y =$ Ideal stress req. in wire drawing operation.

$\epsilon \times \sigma_y \times A_1 =$ Ideal drawing load

Q

$$\text{If } \begin{cases} \alpha = 6^\circ \\ \mu = 0.1 \end{cases} \text{ What is the maximum draft = ?}$$

$$1 = \frac{(1+B)}{B} \left[1 - \left(\frac{A_1}{A_0}\right)^B\right]$$

$$\beta = \mu \cot \alpha$$

Tube drawing operation :-

The method of reducing wall thickness of already existing tubes by pulling through a stationary die with mandril is called as a tube drawing operation.

In the tube drawing operation, the internal dia of the tube may be maintained as constant as earlier or it may be changed.

here also stationary die is used.

Based on the shape of the mandril used - it is divided into 2 types

(1) Cylindrical mandril

Used for maintaining the internal dia of the tube constant.

(2) Conical mandril

For changing the internal dia of the tube

δ - half of cone angle of mandril.

cone angle = 2δ - cone angle.

μ_1 - coeff of friction b/w the outersurface of the tube & die

μ_2 - coeff of friction b/w the inside surface of the tube and mandril.

$$\beta = \frac{\mu_1 \pm \mu_2}{\tan \alpha - \tan \delta}$$

+ \Rightarrow stationary mandril

- \Rightarrow movable mandril (take direction of friction on the tube surface & not on mandril or die surface)

Based on the usage of the mandril - mandril can be divided into 2 types

(1) Stationary mandril

(2) Movable or floating mandril.

mandril reciprocates inside.

If mandril moves backward - direction of frictional force is tube side is in forward direction.

If mandril moves forward - then it depends on the relative values of the mandril & tube

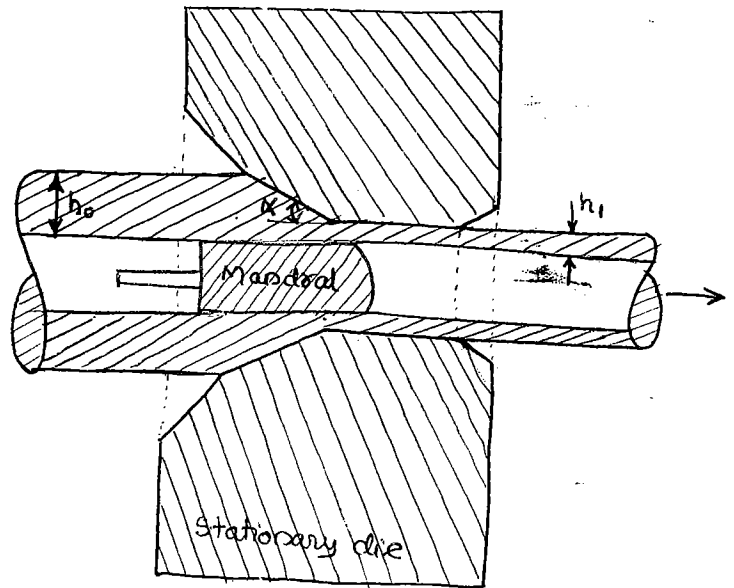

The out surface is backward & the inside surface is forward.
Hence the -ve sign can be taken with movable mandrel.

$$\sigma_2 = \sigma_y \left(\frac{1+\beta}{\beta} \right) \left(1 - \left(\frac{b_1}{b_0} \right)^\beta \right)$$

$$\sigma_2 \times A_1 = \text{Drawing load.}$$

If we assume $\mu_1 = \mu_2$ and we take floating mandrel.

$$\text{Then } \beta = 0.$$

$$\sigma_2 = \frac{0}{0}$$

applying L-hospital's rule; and simplify - we get

$$\sigma_2 = \sigma_y \log_{10} \left(\frac{1}{\left(\frac{b_0}{b_1} \right) - 1} \right)$$

Extrusion Process

Process in which the raw material is compressed in a rigid closed container such that the compressive stresses induced in the material is greater than the flow stress of the material; hence the material is flowing through a small opening available in the container, taking the shape and the size as the remains same as the die opening available in the container.

Advantages

When compared to drawing

(1) The lengthy sizing zone is completely absent in the extrusion process.

(2) Larger amount of extrusion ratios are possible. But the maximum reduction possible in extrusion is 8.

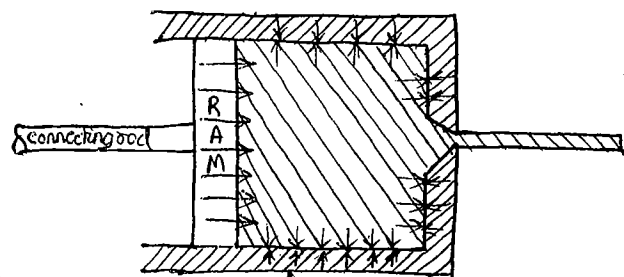

forward extrusion

(3) During wire drawing operation; if the drawing stress applied is greater than the yield stress of the material; the cracking tendency of the wire is very high but in case of extrusion process; there is no cracking tendency.

Types of extrusion

- ① Forward or direct extrusion
- ② Backward or indirect extrusion
- ③ Hydrostatic extrusion
- ④ Impact extrusion

① Forward or direct extrusion

The direction of movement of the ram and direction of movement of extruded component are same.

As the ram is moving; every point on the raw material have to travel against the container wall friction \therefore force required for forward extrusion is higher.

Volume before = volume after

$$A_0 V_0 = A_1 V_1$$

$$V_1 = \frac{A_0}{A_1} \times V_0$$

$$V_1 = (40-50\% \text{ to } 60\%) V_0$$

② Backward or indirect extrusion

The direction of movement of ram and extruded product are in opposite direction.

The raw material can directly deform and flow into the die \therefore No movement of the raw material is required. Hence the force required for the extrusion process is less.

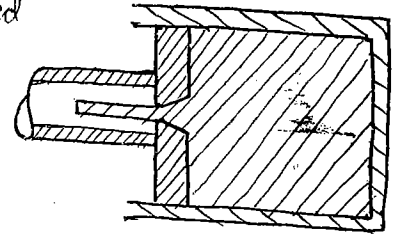

Backward extrusion

From the force vs ram travel diag \rightarrow only at initial process of forward extrusion; the force required is higher. But afterwards the force required for forward extrusion is marginally higher than the backward extrusion. Hence it is not a disadvantage of forward extrusion.

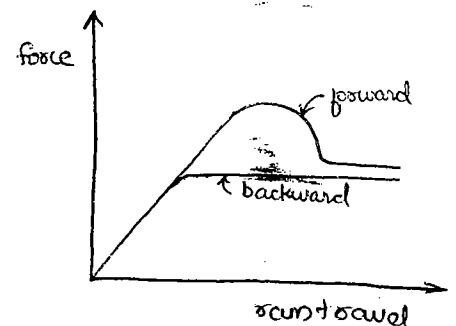

In forward extrusion bcz the extruded component is coming out into the open environment, the handling of the extruded component would be easier; but in case of backward extrusion; the extruded component is going into the connecting rod \therefore the handling is difficult.

The manufacturing of both ram and die are easier in case of forward extrusion bcz they are separate.

Thus forward extrusion is better than the backward extrusion; though the force req. is a bit high.

During extrusion of semi brittle and brittle materials using forward extrusion; bcs of the presence of container wall friction; the cracking tendency of the extruded component is very high. But with backward extrusion; bcs of complete absence of container wall friction; the cracking tendency of extruded component during extrusion of semi brittle and brittle materials will not exist: Hence the backward extrusion is preferable to use for extruding semi brittle and brittle materials.

③ Hydrostatic extrusion:-

- To extrude the semi brittle and brittle materials without container wall friction and with the advantages of forward extrusion - a new methodology called hydrostatic extrusion is developed.

It's similar to the forward extrusion.

Here the full volume of cylinder is not occupied by the raw materials.

& the size of the raw materials is less than the size of the container and the gap is filled by using hydrostatic liquid.

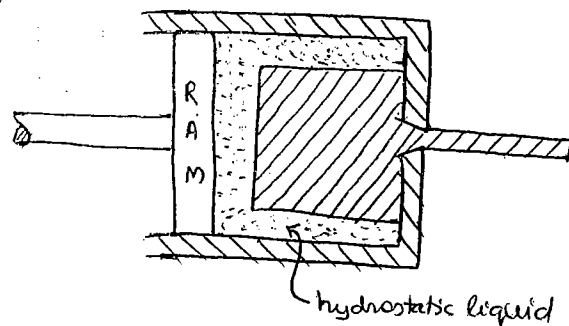

The force applied by using ram will be transferred to the raw materials through the hydrostatic liquid and bcs of presence of the hydrostatic liquid, the container wall friction is completely absent.

∴ the cracking tendency can be eliminated during extrusion of semi brittle, brittle & high strength ^{super} alloys.

Since arresting the burrs during the process of extrusion is very difficult; hence it is limited for only semi brittle, brittle and high strength super alloys only.

The hydrostatic liquids used in the case of hydrostatic extrusion are

(1) At room temp of extrusion → vegetable oils, glycerine, SAE oils, castor oil, isopentane etc. will be used.

(2) At elevated temp of extrusion → wax, polymers, glass, etc. can be used.

4) Impact extrusion :-

The method of producing very thin wall tubes from the solid rods made by very soft material with the application of impact loads is called as impact extrusion.

These are been mainly used for making collapsible tubes.

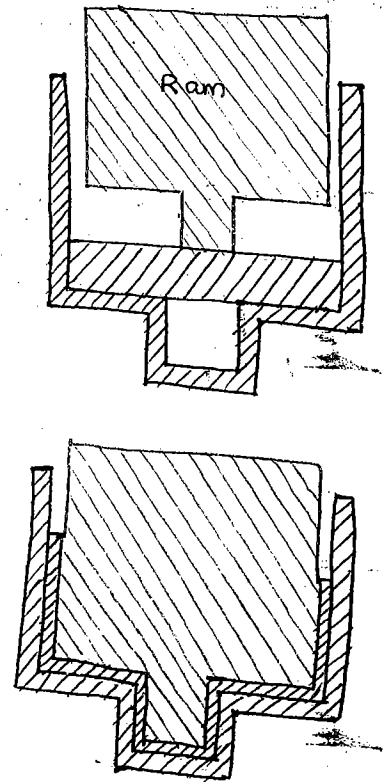
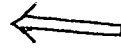
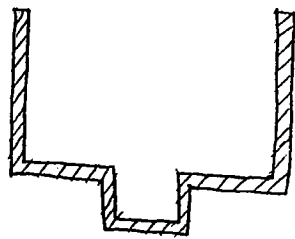

Extrusion force required

① σ_0 = extrusion stress applied by using Ram

$$\sigma_0 = \sigma_y \left(\frac{1+B}{B} \right) \left(1 - \left(\frac{A_1}{A_0} \right)^B \right)$$

$$B = \mu \cot \alpha$$

α - half the die angle
 μ - coeff. of friction

Forward extrusion

$$(EF)_{\text{forward}} = (\sigma_0 + P_f) A_0$$

P_f = pressure required to overcome the container wall force

backward extrusion

$$(EF)_{\text{backward}} = \sigma_0 \times P_0$$

② minimum extrusion force required

$$(EF)_{\text{min}} = \sigma_y \times A_0$$

Actual extrusion force

$$(E \cdot F)_{\text{actual}} = \frac{(E \cdot F)_{\text{min}}}{\eta_{\text{ext}}}$$

η_{ext} - efficiency of extrusion process

$$\begin{aligned} \eta_{\text{ext}} &= 0.4 - 0.5 && \text{- forward} \\ &= 0.5 - 0.6 && \text{- backward} \end{aligned}$$

③ $E \cdot F = K A_0 \ln \left(\frac{A_0}{A_1} \right)$

K - extrusion constant

It depends on the type of extruder, & material to be extruded.

Defects in extrusion :- [These are special defect for extrusion, apart from normal defect]

(1) Bamboo defect :-

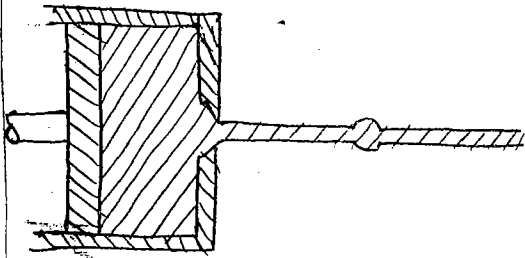

The outer cross section of the extruded component is similar to that of the bamboo stick called as a bamboo defect.

This is bcz of non uniform velocity of the ram during extrusion.

(2) Pipe defect or centre burst

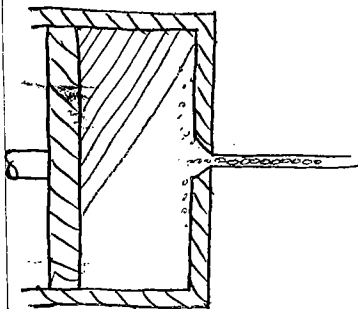

When the heated raw materials ^{are} placed inside the container without proper cleaning, (contains scales); during extrusion; the scales present on the surface of the raw materials may be forming as a central part of extruded component and produces pinholes at the centre of the extruded component which makes the extruded component like a centre burst or pipe shape.

∴ the name called as pipe defect or centre burst.

This can be eliminated by proper cleaning of the raw materials for the scales before placing into the container.

Forging :-

Forging is a process in which the material is compressed b/w the two dies either with the application of continuous load or by using intermittent impact load until the required shape and size of the component is obtained.

A top movable die and bottom stationary die.

Force applied by top die and the material is compressed.

beg of incompressible material

Vol before = Vol after

$$\frac{\pi}{4} d_o^2 h_o = \frac{\pi}{4} d_f^2 h_f$$

$$d_f = d_o \sqrt{\frac{h_o}{h_f}}$$

$$h_f = h_o \left(\frac{d_o}{d_f}\right)^2$$

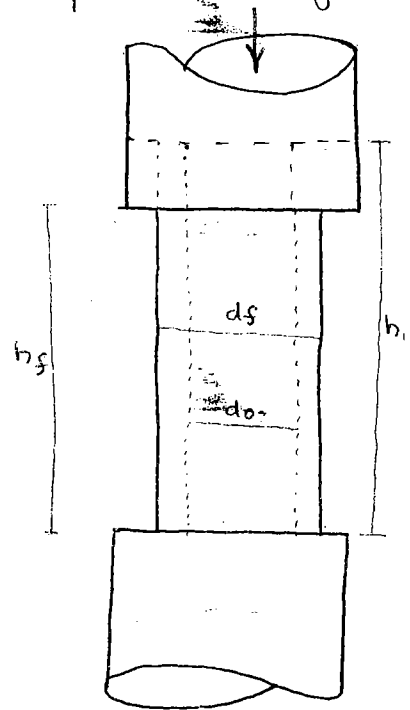

Classifications

(i) based on method of force application

(a) Hand forging operation

only drop hammer type of forging could be applied.

$$P.E = W \times h$$

Impact energy

$$I.E = 2 \times P.E$$

whatever the force applied by human hand is not sufficient to produce the deformation if continuous load application is done.

(b) Machine forging:

The force required for forging is obtained from machines like mechanical press or hydraulic press. It is possible to use either drop hammer type of forging operation or press forging operation.

(2) based on the method of shape obtained

(a) Open die forging :-

Required shape and size of the component can be obtained by changing the position of the component in b/w the blows.

Only drop hammer type of force application could be used.

(b) Closed die forging :-

Also called as impression die forging.

If the req. shape and size of the component is obtained is same as that of the 2 halves of the dies used in the forging operation; called as closed die or impression die forging.

Either continuous or impact type of loads could be used (drop or press forging could be applied).

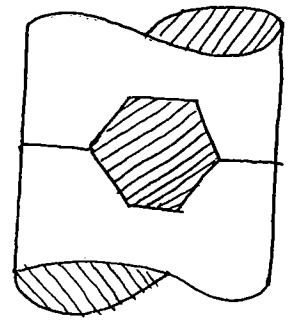
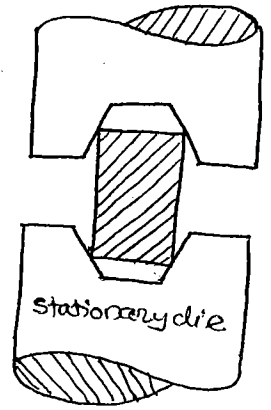

(c) Semiclosed type forging :-

In this the shape and size of the component obtained remains same as the half die used in the forging operation; but the required final size of the component can be obtained by changing the position of the component in b/w the blows.

Only drop hammer type of force application could be used.

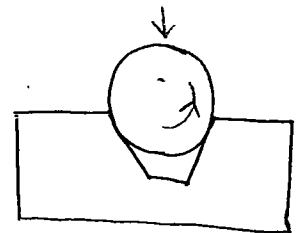

As the force is applied by using the top die and moving the top die, the outward expansion forces are acting throughout the length of the component. But bcz of the presence of the friction at the ends; there is an inward frictional force acting.

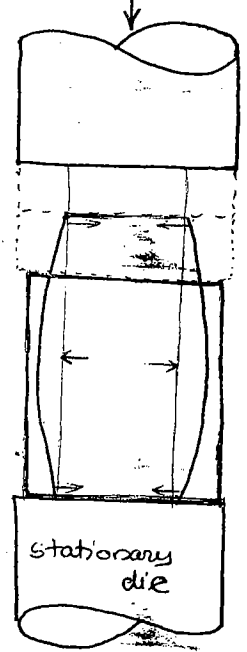

At the initial stages of forging operation; at the ends; the inward frictional forces are higher than the outward expansion forces. \therefore the material is almost sticking to the surface of the dies when we are moving towards the center height of the component; the effect of friction is reducing.

\therefore the material starts expanding and produce barrel shape of the component. Hence the initial part of forging operation is also some times called as barrelling operation.

During the initial stages of forging bcz the material is sticking to the surface of die; the initial part of forging could be analysed by using sticking friction model.

On further application of the force by using top die; the outward expansion forces are continuously increasing; but the inward frictional forces are almost constant. \therefore at some point the outward expansion forces becomes greater than the inward frictional forces.

hence the material starts sliding and the dies produce nearly cylindrical shape of the component. This part of forging operation can be analysed by using sliding friction model.

By observing the is along the length
of the component; but it is transmitted to the component and acting ~~is~~ along

\therefore it is similar to that of the thin cylinder experiencing the internal pressure. Hence the stresses and strains induced in the forged component similar to that of the thin cylinder experiencing the internal pressure.

$$\sigma_h = 2 \sigma_r$$

$$\epsilon_h = 2 \epsilon_r$$

$$e_h = 2 e_r$$

Let V - volume of the final finished component in forging operation.

In open type and semi closed type forging - volume we need the same V volume of raw materials. i.e. the same volume of final finished component is taken as raw materials.

In case of closed type forging

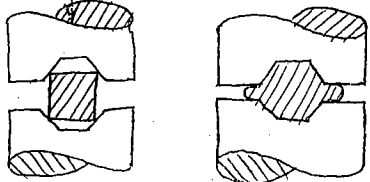

- 10-20% higher volume of than the final finished volume V required is to be taken.

To ensure that dies can be filled completely - even though some material is flowing outward, the excess volume of raw material has to be taken.

if $>20\%$ is used - it results in jamming of dies.

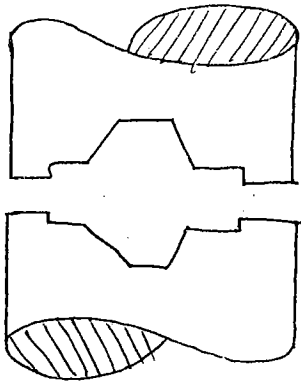

To accommodate the excess volume of material, some amount of open space must be provided in the dies, called as Gutters.

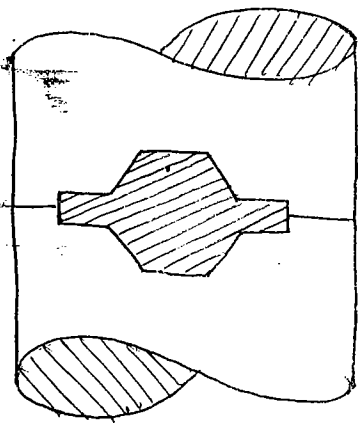

By provision of gutters in the dies, the excess volume of material is filled in the gutters and produce projection in the forged component called as flash.

This flash is a unwanted material and it has to be removed by trimming operation.

Flash is only produced in closed die forging.

Force required in forging operation:

Minimum ^{initial} force req. for forging

$$F_{i\min} = \sigma_y \times A_0$$

Minimum final force

$$F_{f\min} = \sigma_y \times A_f$$

minimum force

$$F_{\text{min}} = \frac{F_{i \text{ min}} + F_{f \text{ min}}}{2}$$

Actual force

$$\text{Fact} = \frac{F_{\text{min}}}{\eta_{\text{avg}}}$$

work done

$$\begin{aligned} W_D &= \text{Fact} \times (h_o - h_f) \\ &= 2 \times W \times H \end{aligned}$$

W -
H -

$$H = \frac{\text{Fact} \times (h_o - h_f)}{2W}$$

Also Actual force is given by

$$\text{Fact} = \sigma_y A_f \left[1 + \frac{2\mu \sigma_f}{3h_f} \right]$$

work done

$$\begin{aligned} W_D &= \text{Fact} \times (h_o - h_f) \\ &= 2 \times W \times H \end{aligned}$$

height of drop of hammer.

$$H = \frac{\text{Fact} \times (h_o - h_f)}{2W}$$

$$A_f = \frac{\pi}{4} d_f^2$$

σ_f - final radius

h_f - final height

μ - coefficient of friction

Types of forging or pre forming operation.

① Fullering:-

It is a method of distributing of the material from center to the outwards non uniformly.

It is fullering operation - the length of the component is increasing and the cross section is reducing non uniformly.

② Drawing operation:-

It's an operation of distributing the material from centre to outward uniformly.

It is this also length is increasing and diameter (cross section) reducing uniformly.

③ Offsetting:-

It's a forging method; to increase the CSA and reducing the length of the component.

④ Edging or Edging:-

Forging method used for collecting the material locally.

⑤ Flattening:-

Forging method used for producing flat surfaces.

⑥ Chamfering:-

Forging method used for converting sharp edged corners into rounded corners.

⑦ Bending:-

Bending the component in the required angle.

⑧ Blocking or swaging:-

Forging method used for producing approximate shape of the components.

⑨ Finishing:-

Forging method used for producing exact shape of the components.

10) Trimming:

It's actually a cutting operation used for removing the flash present in the forged operation.

1-6] - open die forging operation

7-8] - Semi closed

9] - closed

10] - cutting

Q

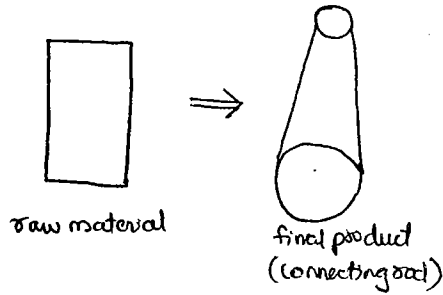

write the forging operations in the sequence.

- since non-uniform cross section and an increase in length — fullering. ①
 since large qty of materials are required at big end side — edging. ②
 — blocking. ③
 — finishing. ④
 — trimming ⑤
- since closed die operation is a trimmer been used so
 Not much sharp edges are there — so No chamfering

⊗ Except the chamfering operation — all the open die forging will be done first; then prefer semi closed type forging operation and then if required; go for closed die forging operation.
 If the closed die forging is done — use the trimming operation to remove the flash.
 after completing the process — if any sharp edges are present in the component — perform the chamfering operation.

Q

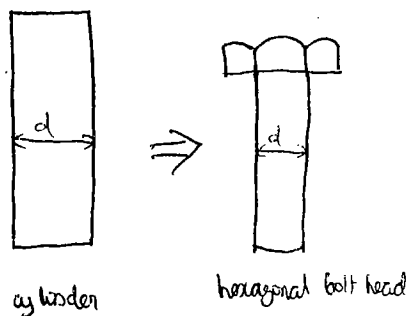

- ① upsetting
 - ② flattening
 - ③ Swaging
(No finishing operation is req)
 - ④ Chamfering
- No trimming is required.

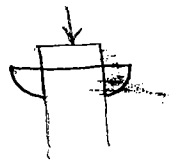

Special defect in forging

Lapping :-

Lap or cold shut :-

Discontinuity produced in a forged component due to bending of the material.

This is mainly produced in case of closed die forging operation.

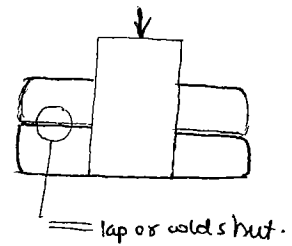

p. 29
Q.1

$$\text{Reduction} = \frac{d_0 - d_1}{d_0}$$

$$d_1 = d_0(1 - \text{reduction})$$

$$d_0 = 15 \text{ mm} \quad d_1 = 0.1 \text{ mm}$$

$$\textcircled{A} \quad d_1 = d_0(1 - 0.8) = 15 \times 0.2 = 3 \text{ mm}$$

$$\textcircled{B} \quad d_2 = d_1(1 - 0.8) = 3 \times 0.2 = 0.6$$

$$d_3 = d_2(1 - 0.8) = 0.6 \times 0.2 = 0.12$$

$$\text{error} = 0.02$$

$$\textcircled{B} \quad d_1 = d_0(1 - 0.8) = 3$$

$$d_2 = d_1(1 - 0.8) = 0.6$$

$$d_3 = d_2(1 - 0.8) = 0.12$$

$$d_4 = d_3(1 - 0.2) = 0.12 \times 0.8 = 0.096$$

$$0.004$$

$$\textcircled{C} \quad d_1 = d_0(1 - 0.8) = 3$$

$$d_2 = d_1(1 - 0.8) = 0.6$$

$$d_3 = d_2(1 - 0.4) = 0.6 \times 0.6 = 0.36$$

$$d_4 = d_3(1 - 0.4) = 0.216$$

$$d_5 = d_4(1 - 0.2) = 0.173$$

$$0.073$$

$$\text{Q.2.} \quad \begin{aligned} d_0 &= 6 \\ d_1 &= 5.2 \\ 2\alpha &= 18 \\ L &= 4 \\ \mu &= 0.15 \\ \sigma_y &= 260 \end{aligned}$$

$$B = \mu \cot \alpha = 0.15 \cot 9^\circ =$$

$$\sigma_z = \sigma_y \left(\frac{1+B}{B} \right) \left[1 - \left(\frac{d_1}{d_0} \right)^B \right]$$

$$= \sigma_y \left(\frac{1+B}{B} \right) \left[1 - \left(\frac{d_1}{d_0} \right)^{2B} \right]$$

$$= 260 \left(\left[1 - \left(\frac{5.2}{6} \right) \right] \right)$$

=

$$\sigma_t = \sigma_y + (\sigma_z - \sigma_y) e^{-\frac{2\mu L}{R_1}}$$

$$TDL = \sigma_t \times A_1$$

$$= \frac{\pi}{4} \sigma_t \times \frac{\pi}{4} d_1^2$$

=

Q.3

$$\left. \begin{aligned} H_0 &= 20 \\ H_1 &= 14 \end{aligned} \right\} \Delta H = 20 - 14 = 6$$

$$R = \frac{480}{2} = 240$$

$$\alpha = \tan^{-1} \sqrt{\frac{\Delta H}{R}}$$

$$= \tan^{-1} \sqrt{\frac{6}{240}} =$$

at max rad

$$\alpha = \beta$$

$$u = \tan \beta = \tan \alpha = 0.158$$

$$H_m = H_1 + (0.2 + 0.3) \Delta H$$

$$= 14 + (0.2 + 0.3) \times 6$$

$$= 15.2 \text{ to } 15.8 = \underline{\underline{15.3}}$$

$$\text{forward slip} = \frac{V_1 - V}{V}$$

$$= \frac{V_1}{V} - 1 = \frac{H_0}{H_1} - 1$$

$$= 9\%$$

$$\text{Backward slip} = \frac{V - V_0}{V}$$

$$= 1 - \frac{V_0}{V} = 1 - \frac{H_0}{H_1}$$

$$= 23\%$$

$$\text{maximum pressure} = 16.5$$

Q.8

$$H_0 = 3.5 \quad \mu = 0.08$$

$$\mu_1 = 2.5 \quad \sigma_y = 140$$

$$R = 125,$$

$$b = 450$$

roll separately force

$$R \cdot S.F. = \frac{2}{\sqrt{3}} \sigma_y (bL) \left(1 + \frac{\mu L}{4H} \right)$$

$$L = \sqrt{RDH} = \sqrt{125 \times 4}$$

$$\mu = \frac{3.5 + 2.5}{2} = \underline{\underline{3.0}}$$

$$R \cdot S.F. = 2.771$$

Q.9

$$h_0 = 2.6$$

$$h_1 = 1.8$$

$$2x = 18$$

$$\mu = 0.12$$

→ both μ_1 and $\mu_2 = 0.12$ can be taken

It's supposed to take cone menbrul but

for that the level is req. - but not given

So it's impossible to calculate δ (level etc)

So discontinuity and $\alpha = 0$

$$B = \frac{\mu_1 + \mu_2}{\tan \alpha}$$

Stationary menbrul

$$B = \frac{\mu_1 + \mu_2}{\tan \alpha}$$

$$\frac{\sigma_z}{\sigma_y} = \left(\frac{1+B}{B} \right) \left(1 - \frac{h_1}{h_0} \right)^B = 0.664$$

movable menbrul

$$\mu_1 = \mu_2 \quad B = 0$$

$$\frac{\sigma_z}{\sigma_y} = \log_{10} \left(\frac{1}{\frac{h_0}{h_1} - 1} \right) = 0.356$$

Q.11

$$A_0 = 25 \times 5 = 125 = \frac{A_0 - A_1}{A_0} = 0.4$$

$$\mu = 0.1 \text{ (cone)}$$

$$\sigma_y = 300$$

$$\text{die angle} = 26.5$$

$$\alpha = 13.25$$

$$B = \mu \cot \alpha$$

$$\sigma_z = \sigma_y \left(\frac{1+B}{B} \right) \left(1 - \frac{A_1}{A_0} \right)^B$$

$$DL = \sigma_z \times A_1$$

Q12 $\mu = 0.2$
 $\alpha = 6^\circ$
 $B = \mu \tan \alpha$

$$\frac{\sigma_2}{\sigma_1} = 1 = \left(\frac{1+B}{B}\right) \left[1 - \left(\frac{A_1}{A_0}\right)^B\right]$$

$$\frac{A_1}{A_0} = \left(\frac{d_1}{d_0}\right)^2 = ()$$

$$d = d_0 \sqrt{()}$$

$d_0 = 6 \text{ mm}$ $d_f = 1.34$

if $d_1 = d_f$ $d_1 \leq 1.34$ $n=1$
 $d_2 \leq 1.34$ $n=2$

$d_1 = d_0 \sqrt{\quad} \leq 1.34$ $n=1$

$d_2 = d_1 \sqrt{\quad} \leq 1.34$ $n=2$

$d_3 = d_2 \sqrt{\quad} \leq 1.34$ $n=3$

Ans $n=6$

Q14 $\frac{\pi}{4} d_0^2 L_0 = \frac{\pi}{4} d_f^2 L_f$
 $L_f = L_0 \left(\frac{d_0}{d_f}\right)^2$

$$\epsilon = \ln\left(\frac{A_0}{A_1}\right) = 2 \ln\left(\frac{d_0}{d_1}\right)$$

$$\geq 0.4$$

$0.2 \Rightarrow 300 (\sigma_y)$

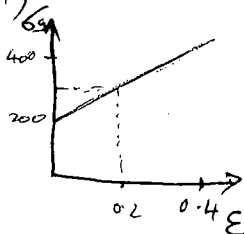

Q16

$$\sigma = 315 \epsilon^{0.54} =$$

$$\epsilon = 2 \ln\left(\frac{d_0}{d_1}\right) = 2 \ln\left(\frac{25}{5}\right) =$$

Q17

$d_0 = 100$ $b_f = 40$
 $b_0 = 50$

$$d_f = d_0 \sqrt{\frac{b_0}{b_f}} =$$

$$f_{mis} = \sigma_y \times A_0$$

$$f_{fms} = \sigma_y \times A_f$$

$$f_{mis} = \frac{f_{mis} + f_{fms}}{2} =$$

= fact.

$$w.o = \text{fact} \times (b_0 - b_f)$$

Q18

$$H = \frac{\text{fact} (b_0 - b_f)}{2 \times 10 \times 10^3}$$

Q19

$$E_{f_{mis}} = \sigma_y \times A_0 = 10 \times \frac{\pi}{4} \times 100^2$$

$$E_{\text{fact}} = \frac{E \cdot f_{mis}}{0.4}$$

$$= 196 \text{ ton}$$

Capacity = 200 ton.

Q20

At max load

$$\text{true strain} = \epsilon = \frac{1}{3}$$

$$\text{True stress} = 1400 \epsilon^{0.33}$$

$$= 1400 \left(\frac{1}{3}\right)^{0.33}$$

$$\underline{\underline{\geq 971}}$$

SHEET METAL OPERATIONS

7/10/11

9-1 pm.

ref: Workshop Technology by Pollack

The operations performed on the sheets to get the required shape is called sheet metal operations.

cutting operation

1. Punching or Piercing operation

2. Blanking

3. Deep drawing

forming operations

4. Bending

5. Perforating

6. Notching

7. Lancing

8. Slitting

9. Nibbling

10. Trimming

Major operations
[most commonly used]
(Syllabus)

minor operation
(to match the following)

Cutting operations

Punch and die operation is done.
A small $5-8^\circ$ inclination is provided in the die for easy removal.
Shearing occurs and a piece is been removed.

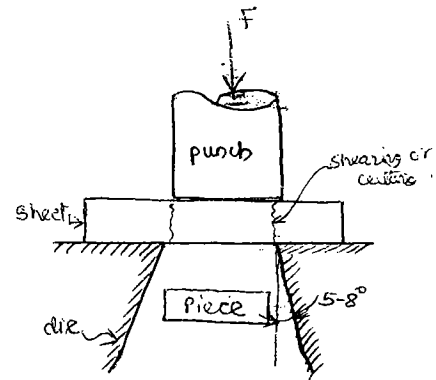

Punch size $<$ Die size.

The shape of punch and die is same as the part to be produced.

In punch and die working operation - if the hole produced in the sheet is useful. Then it is called as punching or piercing operation.

In punching operation; the punch size is made equal to the hole size and the clearance is provided only of the die.

also in punching the shear is provided only on the punch.

In punch and die working operation; if the piece or blank produced is useful one; called as blanking operation.

In blanking the die size is made equal to blank size and clearance is provided only on the punch.

Also in blanking the shear is provided only on the die.

Mechanism

When the force is applied by using the punch on to the sheet, the top surface of the sheet is experiencing elastic compressive deformation and bottom surface of the sheet is experiencing elastic elongation.

But the amount of compression on the top is greater than the amount of elongation at the bottom.

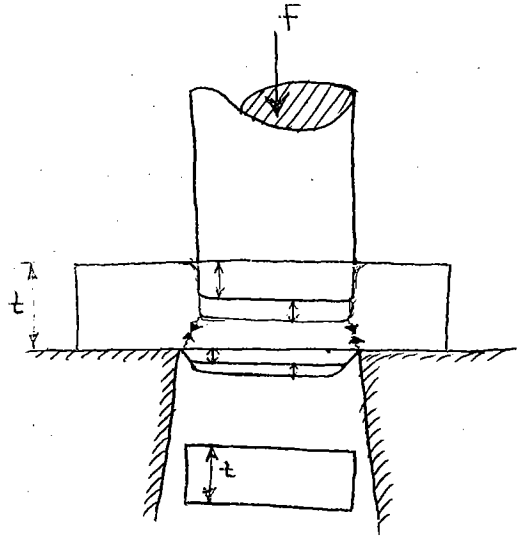

Due to this difference in compression and elongation; the sheet metal present b/w punch and die is experiencing shear stresses.

On further application of force by using the punch; the difference b/w the compression and elongation increases continuously.

∴ the shear stresses is also increasing.

∴ at some point the shear stresses induced in the sheet will become greater than or equal to the ultimate shear stresses of the sheet metal. Hence the shearing or cracking start take place at the ~~eg~~ edges of punch and die [only at edges ~~due to stress concentration~~].

and propagating in their respective directions, meeting somewhere in the mid cross section. so that the piece get separated from the sheet producing a hole in the sheet. [same thickness]

Thus the mechanism by which the cutting of the sheet taking place is shearing and tearing.

During punching and blanking operation, the optimum clearance b/w punch and die must be selected such that the crack propagations produced from the edges of punch and die is meeting somewhere in the mid cross section.

Let

c = optimum clearance [radial]

$$= 0.0032 z \sqrt{\tau_u}$$

z - thickness of sheet in mm

τ_u - ultimate shear stress in MPa

$$= 5\% t \quad \text{if } t \leq 2\text{mm}$$

$$= 10\% t \quad \text{if } t > 2\text{mm}$$

If the clearance provided is less than the optimum clearance, the crack propagations will not meet and they produce a 3 piece configuration.

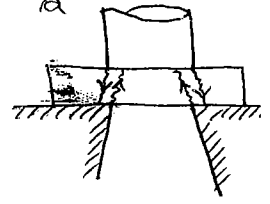

If the clearance provided is ^{greater} than the optimum clearance; then no cutting takes place and the sheet would be dragged into the hole.

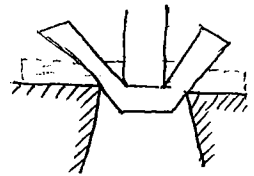

Punching

$$\text{Punch size} = \text{Hole size}$$

$$\text{Die size} = \text{Punch size} + \text{clearance}$$

Blanking

$$\text{Die size} = \text{Blank size}$$

$$\text{Punch size} = \text{Die size} - \text{clearance}$$

The selection of punch and die sizes in punching and blanking operations is mainly based on the burnishing area produced on the respective useful components.

After the cutting and shearing action has been completed; the edges of the holes and blank produced are like a zigzag edges; hence the components cannot be used directly.

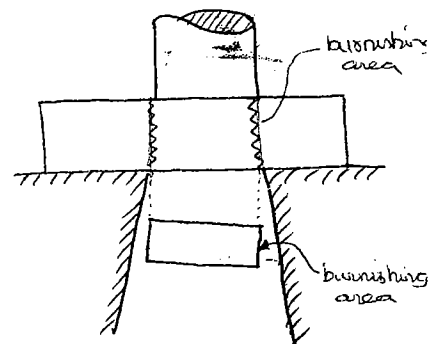

In punch and die working when the force is applied by using punch; after the cutting action; the zigzag edges present on the components will get converted to straight and smooth edges by plastic deformation as the punch is pressed.

The area of the component on which the zigzag edges has get converted into straight and smooth edges is called burnishing area.

The burnishing area on the hole is produced by the punch and the burnishing area on the blank is produced by the die.

will be taken equal to hole size in punching.

On the blank, the burrishing area is produced bcz of the die
 \therefore the blank size is exactly equal to the die size and hence the die size is taken as blank size in blanking.

Q If hole of dia 30mm exists in a sheet of thickness 2mm and clearance of 5%. Determine the punch and die size.

operation required is punching

$$\begin{aligned} \text{punch size} &= \text{hole size} \\ &= 30 \text{ mm } \phi \end{aligned}$$

$$\text{die size} = \text{punch size} + \text{clearance}$$

$$= 30 \text{ mm} + 2 \text{ 'C'}$$

↳ radial die

$$= 30 + 2 \times \frac{5}{100} \times 2$$

$$= 30.2 \text{ mm}$$

Since size is given as diametrical we should do in same form.

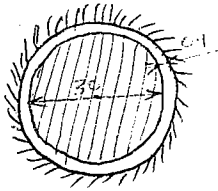

Q Produce a blank of radius 20mm on a sheet of 3mm thickness. clearance to be taken is 8%. determine ~~and~~ punch & die size.

blanking operation

$$\begin{aligned} \text{die size} &= \text{blank size} \\ &= \underline{20 \text{ mm}} \end{aligned}$$

$$\text{clearance} = \frac{8}{100} \times 3 = 0.24$$

$$\text{punch size} = \text{die size} - \text{clearance}$$

$$= 20 - 0.24$$

$$= \underline{19.76 \text{ mm}}$$

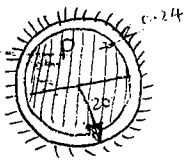

* Q

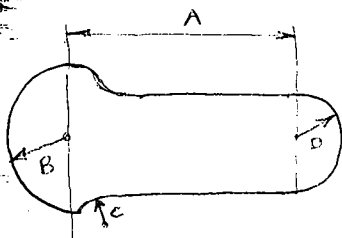

	A	B	C	D
hole	30	20	10	15
$t = 1 \text{ mm}$				
$c = 5\% t$				
$= 0.05 \text{ mm}$				

Part	A	B	C	D
hole	30	20	10	15
P.S	30	20	10	15
D.S	30	20.05	9.95	15.05

clearance
 $C = 5\% t$
 $\approx 0.05 \text{ mm}$

dimension A - not experiencing any cutting action
 so - No change - No clearance req.

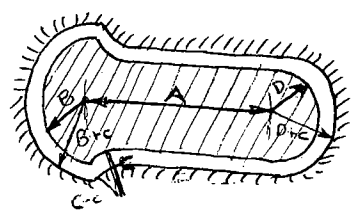

Load estimation in punching and blanking operation

$$W_{\text{force}} = F_{\text{max}} = A_s \tau_u$$

- τ_u - Ultimate shear stress
- A_s - sheared area
- = (perimeter) $\times t$
- = $(\pi d) t$ - circular
- = $4a t$ - square
- = $2(a+b) t$ - rectangular.

Work Done = $E = F_{\text{force}} \times \text{dist}$

$$E = F_{\text{max}} \times kt$$

k - % penetration req for complete shearing action
 $\geq 20-60\%$

Soft materials - 60%
 hard materials - 20%

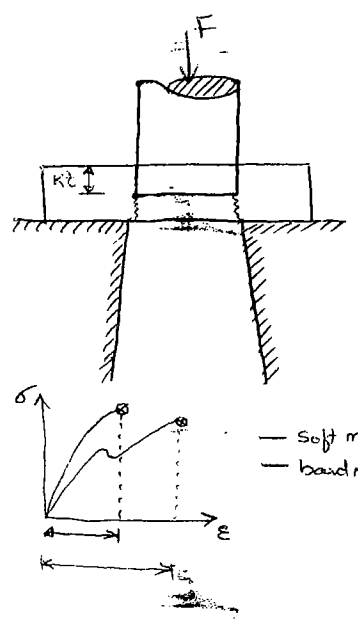

Now to reduce the work done - we should reduce the force.

$$\downarrow F_{\text{max}} = A_s \downarrow \tau_u \downarrow$$

τ_u - can't be reduced in the punching and blanking is always done at

$$F_{th} AS \downarrow \Rightarrow AS = P_{\downarrow} \times Z_{\downarrow}$$

$\frac{\pi d \downarrow}{\text{--- can't do.}}$ $\frac{Z_{\downarrow}}{\text{--- can't do.}}$

So we would try to reduce AS in stage wise.

like is case of apple [apple size > mouth size but we cut into pieces & eat] :-

In cutting and blanking operation; when the operation is performed in the normal methodology, the total sheared area will be cut at a time; hence the force required will become higher. If we reduce this force required, the total sheared area will be cut slowly and progressively; at any one point of time; the sheared area under cutting action is less than the total sheared area; but by the end of the process; the total sheared area will be cut.

Methods of reducing punch force.

① By providing shear:-

Provision of the shear is nothing but making the face of punch or die inclined.

From the figure, it is clear that the sheared area under the cutting action is less than the total shear area at any one point of time during the cutting action.

Hence the force required is reduced.

If shear is provided on both the elements punch & die - both the components i.e hole produced in the sheet and the blank will become unusable. \therefore it is always required to provide the shear on only one element.

If punch is provided with shear - the blank will be deformed (subjected to bending)

If die is provided with shear - the sheet or hole would be deformed.

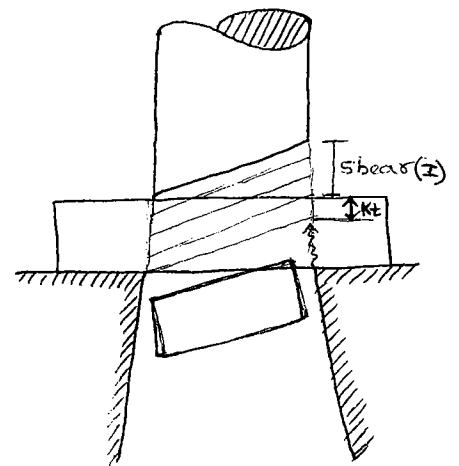

provision of shear on the punch.

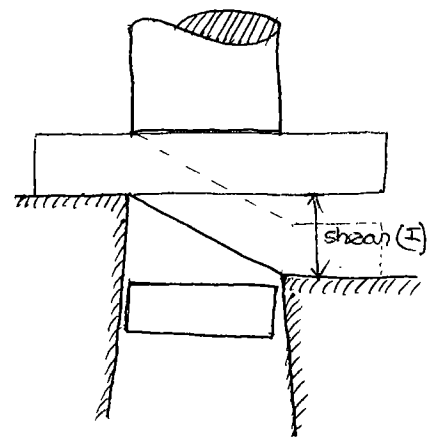

and to make it possible; the shear must be provided only on the punch. where as in case of blanking; to make the blank useful the shear must be provided only on the die.

*The work done or energy required for performing the given operation ~~is~~ remains constant irrespective of the ~~method~~ method of provision of shear.

i.e. the work done with shear = work done without shear.

$$F (Kt + I) = F_{max} Kt$$

$$F = \frac{F_{max} \times Kt}{(Kt + I)}$$

$$I = \frac{F_{max} Kt}{F} - Kt$$

As the shear provided increases — the punch would become weaker and chance of failure increases. So there is a maximum value of shear that could be provided.

Maximum value of shear that could be provided

$$K = 50\%$$

$$I = t/3$$

$$F = \frac{F_{max} \times 0.5t}{0.5t + \frac{t}{3}} = 0.6 F_{max}$$

40% is reduced by mere $\frac{t}{3}$

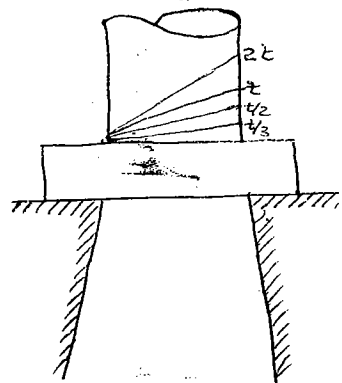

$$K = 50\%$$

$$I = t/2$$

$$F = \frac{F_{max}}{2} = 0.5 F_{max}$$

50% reduction

$$K = 50\%$$

$$I = t$$

$$F = \frac{F_{max}}{3} = 0.33 F_{max}$$

67% reduction

$$K = 50\%$$

$$I = 2t$$

$$F = \frac{F_{max}}{5} = 0.2 F_{max}$$

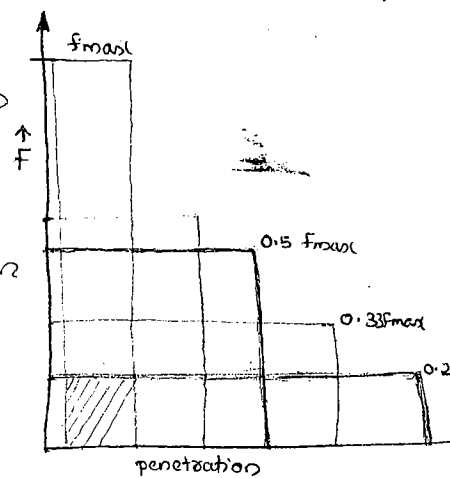

* Area under the curves remains same

when compared to $I = t$ with $I = 2t$; the additional force reduction is only about 13%. But for the corresponding I ; the life of the tool is reduced by 50% nearly 40-50%. Hence it is not preferable. Max. maximum amount of shear — one can provide on the punch or die is \leq sheet thickness

by singly or by two punches
 this method is applicable only when more than one operation is performed
 in one stroke.

In this method the lengths of the
 successive punches has been reduced
 by an amount greater than or
 equal to the kt ($\geq kt$) so that
 only one punch is in contact with
 the sheet at any given point of
 time.

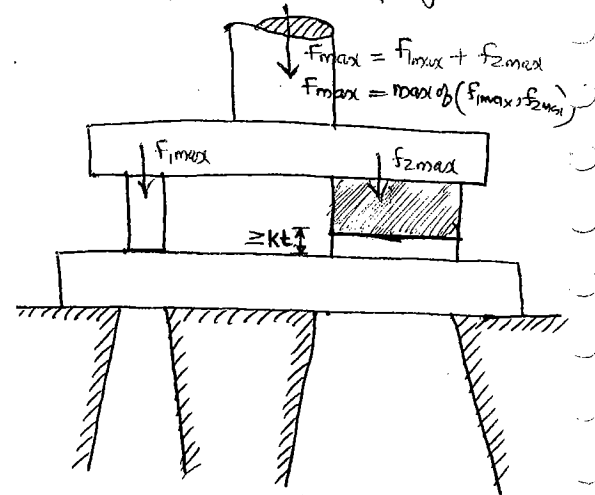

If both the lengths were same then
 the sum of the two force required
 should be provided initially.

but if only one comes in contact at a time then only the
 maximum cutting force among the punches operation is only required.

If there are n number of operations simultaneous occur then

$$F_{max} = \text{maximum of } [F_{1max}, \dots, F_{nmax}]$$

Limitation :-

Balancing of forces on the punchhead is very difficult.

③ Combination of shear and staggering :-

Even though the combination method
 is reducing the force requirement to
 a smaller value;

the balancing of the forces on the
 punch head is almost impossible. \therefore
 it cannot be used in practical
 applications.

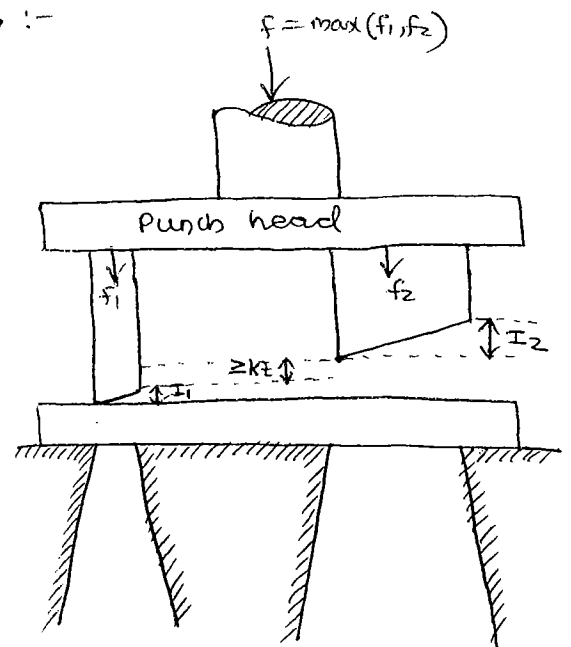

Compressive stresses induced in punch material

When F_{max} is the force applied by
 using punch on to the sheet; an equal
 and opposite reaction force produced by the
 sheet is acting on to the punch. \therefore

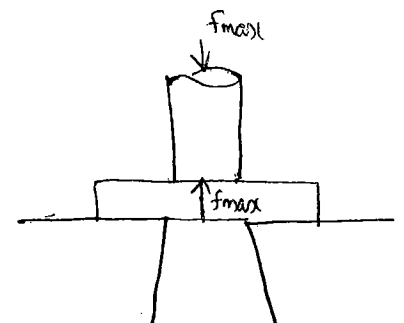

The punch is experiencing compressive or crushing stresses.

compressive stress induced in punch material

$$\begin{aligned}\sigma_{cp} &= \frac{F_{max}}{A_{cp}} \\ &= \frac{F_{max}}{\frac{\pi}{4} d^2} \\ &= \frac{\pi d t \tau_u}{\frac{\pi}{4} d^2}\end{aligned}$$

$$\sigma_{cp} = \frac{4 t \tau_u}{d}$$

As the hole size to be produced is increasing the compressive stress induced in the punch is reducing; hence the punch is safe. But if the dia of the hole to be produced is reducing; the compressive stress induced in the punch increases;

At some point the compressive stress induced in the punch may become greater than the allowable compressive stress in the punch material. \therefore the punch may fail at any time.

To avoid this it is required to restrict the minimum size of the hole produced.

$$d_{min} = \frac{4 t \tau_u}{\sigma_{cp \text{ allowable}}}$$

$$\begin{array}{l|l} \text{if } \tau_u = \sigma_{cp \text{ allowable}} & \text{and if } \sigma_{cp} = 4 \tau_u \\ \text{then } d_{min} = 4 t & \text{then } d_{min} = t \end{array}$$

This case is only taken in case of punching (only there we require the small holes - small blanks are never produced)

Strap strip layout in blanking

It is considered only in blanking operation and not in punching operation.

The layout by which the blanks are produced from the sheet such that the % utilization of the sheet is maximum

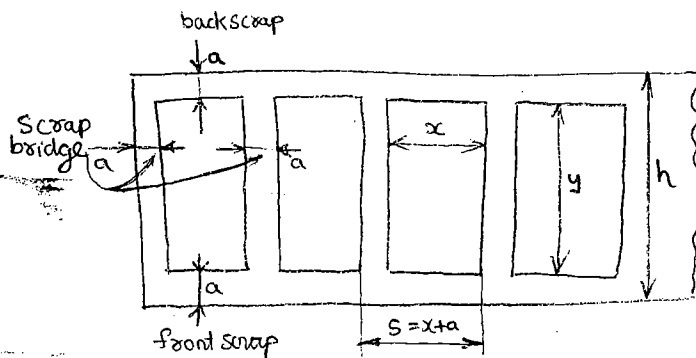

margin is always provided to remove the unevenness present on the edges of the sheet and also to remove the edge damages; takes place during the transportation of the sheet from one place to another place.

$$\begin{aligned}
 a &= \text{margin} \\
 &= 0.8 \text{ mm}, \text{ if } t \leq 0.8 \text{ mm} \\
 &= t, \text{ if } t = 0.8 + 0.3 \cdot 2 \\
 &= 3.2 \text{ mm}, \text{ if } t \geq 3.2 \text{ mm}
 \end{aligned}$$

$$h = y + a + a = y + 2a$$

$$S - \text{feed of sheet} = (x + a)$$

L - total length of sheet available

n - no of blanks produced

$$n = \frac{L - a}{S} \approx \frac{L}{S} \Rightarrow L = nS$$

$$\% \text{ utilization} = \frac{\text{area utilized}}{\text{total area of sheet}}$$

$$= \frac{n \times (x \times y)}{L \times b}$$

$$= \frac{n(x \times y)}{(nS) \times b}$$

$$= \frac{xy}{S \times b}$$

To determine the % utilized we do not require the length of the sheet

constant area

The repeatable area that can be considered in blanking operation is called as control area. $[s \times b]$

To identify the control area draw a line at any one point and then draw other line corresponding to the same point at similar point. Then the area in b/w is called control area.

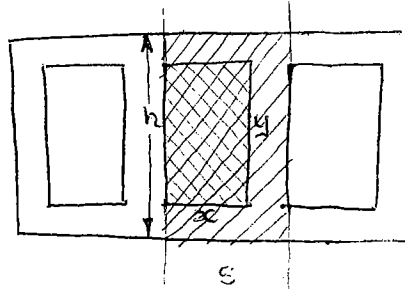

$$\% \text{ utilization} = \frac{\text{Area of blanks}}{\text{Area of control area}}$$

Q. Equal No: of circular blanks of dia 100mm and 60mm are to be produced from a sheet of thickness 2mm. with margin = 2mm. Design a strip strip layout which is giving maximum % utilization of the sheet.

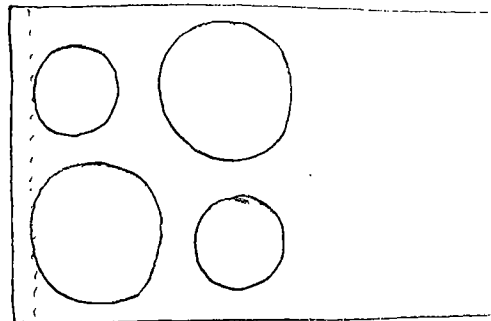
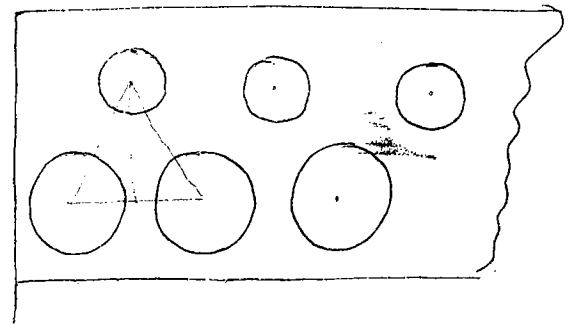
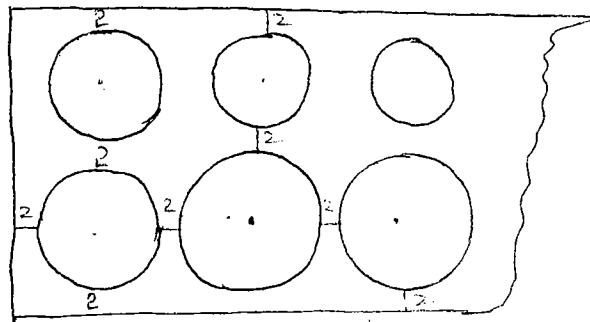

Handwritten text along the left margin, possibly bleed-through from the reverse side of the page. The text is faint and difficult to decipher but appears to be a list or series of entries.

Handwritten text along the right margin, possibly bleed-through from the reverse side of the page. The text is faint and difficult to decipher but appears to be a list or series of entries.

forming operations

3 Deep drawing

It's a forming operation in which the forces are applied on the material such that the stresses induced is greater than the yield strength and less than the ultimate so that the material deforms plastically to change the shape of the component.

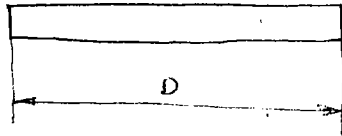

cylinder circular shape

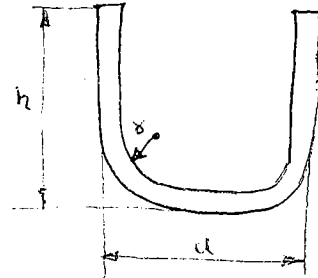

mainly it is used for producing cup shaped components

if $\frac{b}{d} < 0.5 \Rightarrow$ shallow drawing

$\frac{b}{d} \geq 0.5 \Rightarrow$ deep

if $\frac{d}{r} \geq 20 \Rightarrow$ corner radius is negligible

By neglecting the corner radius, one side surface area of the blank is equal to the one side surface area of the component.

By using this principle we could find the size of the blank required if we know the dimensions of cup to be produced.

$$\frac{\pi}{4} D^2 = \frac{\pi}{4} d^2 + \pi d h$$

$$D^2 = d^2 + 4 d h$$

$$D = \sqrt{d^2 + 4 d h}$$

$\frac{d}{r} \geq 20$ corner radius neglected

$$D = \sqrt{d^2 + 4 d h} - \frac{r}{2}$$

$$\frac{d}{r} = 15 - 20$$

$$D = \sqrt{d^2 + 4 d h} - r$$

$$\frac{d}{r} = 10 - 15$$

if $\frac{d}{\delta} < 10$ - Total surface area of the blank must be made equal to total surface area of the component.

but finding total surface area is
 bit complicated, so not seq. to
 exam point of view.

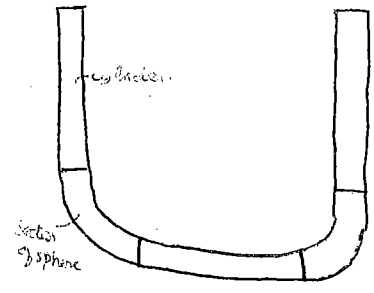

* Q Design the blank

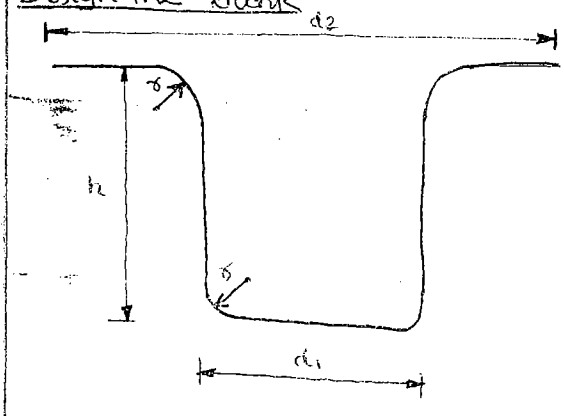

Ans:-

$$\frac{\pi}{4} D^2 = \frac{\pi}{4} d_1^2 + \pi d_1 h + \frac{\pi}{4} (d_2^2 - d_1^2)$$

$$D^2 = d_2^2 + 4 d_1 h$$

$$D = \sqrt{d_2^2 + 4 d_1 h} \quad \frac{d_1}{\delta} \geq 20$$

$$D = \sqrt{d_2^2 + 4 d_1 h} - \frac{\delta}{2} \quad \frac{d_1}{\delta} = 15$$

$$D = \sqrt{d_2^2 + 4 d_1 h} - \delta \quad \frac{d_1}{\delta} =$$

* Determine the blank dia

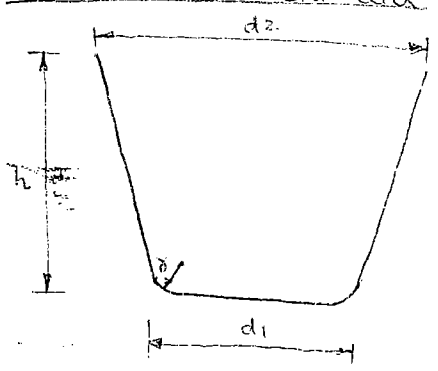

$$\frac{\pi}{4} D^2 = \frac{\pi}{4} d_1^2 + \pi d_1 h$$

$$D^2 = d_1^2 + 4 d_1 h$$

$$D = \sqrt{d_1^2 + 2(d_1 + d_2)h}$$

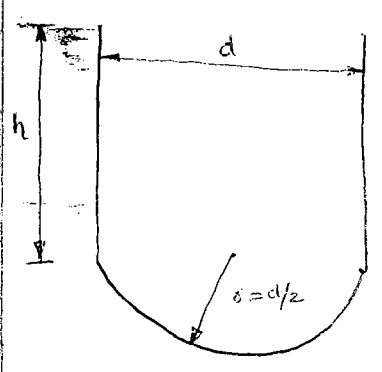

$$\frac{\pi}{4} D^2 = \pi d h + \frac{\pi d^2}{2}$$

Sphere
 $\frac{4}{3} \pi r^2$
 πd^2

$$D^2 = 4 d h + 2 d^2$$

$$D = \sqrt{4 d h + 2 d^2}$$

In all the above cases, it is assumed that the thickness of the component and thickness of blank are same.

a) Determine the radius of the blank required, to produce a hemispherical cup of radius 200mm.

$$\frac{\pi D^2}{4} = \frac{\pi d^2}{2}$$

$$D = \sqrt{2} d$$

$$R = \sqrt{2} r$$

$$= \sqrt{2} \times 200$$

$$= \underline{\underline{282.8 \text{ mm}}}$$

As to punching and drawing operations; deep drawing is also having a punch and die combination.

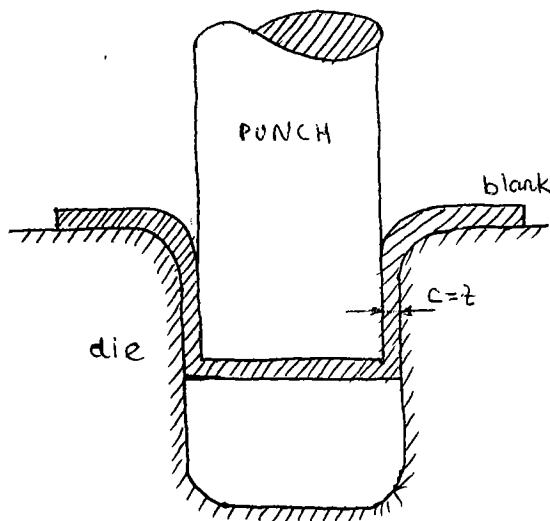

here the clearance varies

$$\text{Clearance} = \text{Sheet thickness}$$

$$c = t$$

So in case of the punching the optimum clearance is ≈ 5 to $10\% t$.

When the force is applied by using the punch, the sheet will be simply

repelled into the die by shearing action. In corners the stress would become greater than yield but less than ultimate.

If the deep drawing operation is performed at one stage itself, the forces to be applied on the sheet is very high. \therefore even though the average stress included in the sheet is less than the ultimate stress but some local areas of the sheet may experience stresses greater than the ultimate. Hence the localized cracking may take place, which leads to leakages taking place during usage of the component.

To overcome this problem, it is always recommended to perform the deep drawing operation in more than one stage or more than one draw.

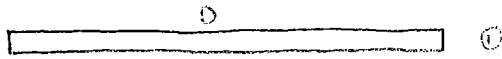

①

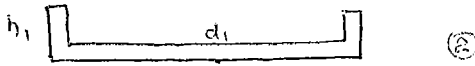

②

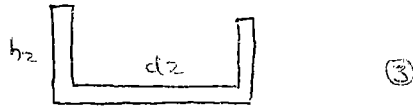

③

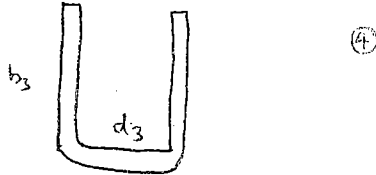

④

Though we are doing the drawing in stages; the eqn

$$D = \sqrt{d^2 + 4dh}$$

d, h is the final shape required for the (dimen) of D is the blank dia req.

But this eqn is also applicable for intermediate stages too (for calcn $h_1, h_2, h_3 \dots$)

In deep drawing operation for each and every stage; a separate punch and die combination will be used.

Load required in Deep drawing

P = load required in deep drawing

$$P = \pi d t \sigma_y \left(\frac{D}{d} - c \right)$$

σ_y - Yield stress

D - blank dia

t - thickness of sheet

c - a constant to cover friction, bending, corner radius etc

$$c = 0.6 - 0.7$$

if we neglect friction, bending & corner radii $c = 0$.

Also for different stages

$$P_1 = \pi d_1 t \sigma_y \left(\frac{D}{d_1} - c \right)$$

$$P_2 = \pi d_2 t \sigma_y \left(\frac{d_1}{d_2} - c \right)$$

$$P_3 = \pi d_3 t \sigma_y \left(\frac{d_2}{d_3} - c \right)$$

d_1, d_2, d_3 - are the diameters of the component after the 1st, 2nd and 3rd stages of drawing respectively

If $c = 0$

$$P_1 = \pi D t \sigma_y$$

$$P_2 = \pi d_1 t \sigma_y$$

$$P_3 = \pi d_2 t \sigma_y$$

Work done

$$W \cdot D = \text{force} \times \text{distance}$$

$$W D = P \times h$$

$$W D_1 = P_1 \times h_1$$

$$W D_2 = P_2 \times (h_2 - h_1)$$

$$W D_3 = P_3 \times (h_3 - h_2)$$

distance moved by the punch.

Blank Holder force

During deep drawing operation; when the force is applied by using the punch on to the blank; the edges of the blank are lifting upwards which produces wrinkles on the deep drawing component.

These wrinkles are making the appearance of the component very bad.

∴ it is required to eliminate the formation of the wrinkles.

∴ this the lifting of the edges has to be avoided. This is possible by applying force onto the blank called as blank holder force (BHF)

If BHF is > drawing force then tearing of sheet occurs.

so BHF should be less than drawing force.

$$BHF = \frac{1}{3} P$$

The optimum blank holder force applied is $\frac{1}{3}$ of the drawing force so that the lifting of the edges of the blank will be eliminated and the drawing process will also be easier.

$$BHF_1 = \frac{P_1}{3}$$

$$BHF_2 = \frac{P_2}{3}$$

$$BHF_3 = \frac{P_3}{3}$$

The blank holder force required in case of deep drawing operation can be obtained by using spring loaded stripper plate.

by controlling the compression of spring we could control the force.

BHF is maintained till the punch is been ^{completely} removed after the deep drawing operation so that component is ^{retained} inside the die.

bcz - while deep drawing there is chance of sheet sticking to the punch. then it would be difficult to remove.

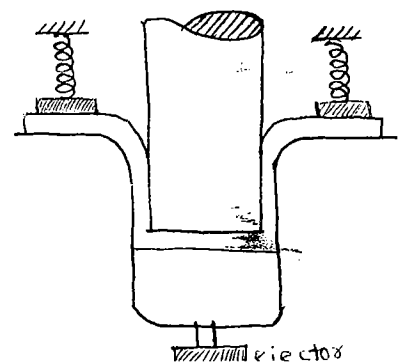
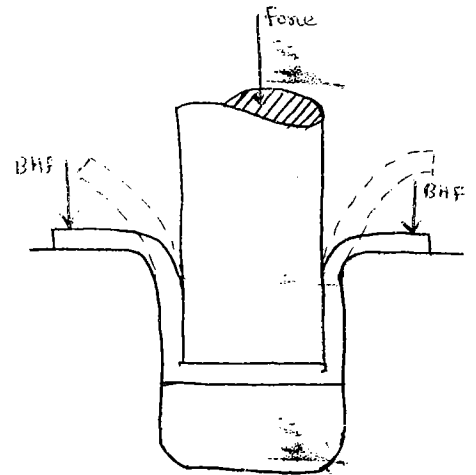

But if in the die it could be easily removed by providing an ejector - ejector can't be used in punch as it is longer and also hole cannot be drilled in punch due to stress concentration.
(longer ejector would)

Stresses induced in deep drawing

Zone 1 - Bottom of punch zone

without BHF = No stresses

with BHF = Tensile stress induced.

Zone 2 - Deformation zone

Deformation req. for converting blank to component is obtained here.

without BHF = Tensile stress

with BHF = Tensile stress

Compressive stresses in the corner are negligible

Zone 3 - Flange position

without BHF = Tensile in 2-direction and compressive in 3rd direction

with BHF = Tensile (No compressive force by BHF as the component is moving so no reaction is offered back to compen)

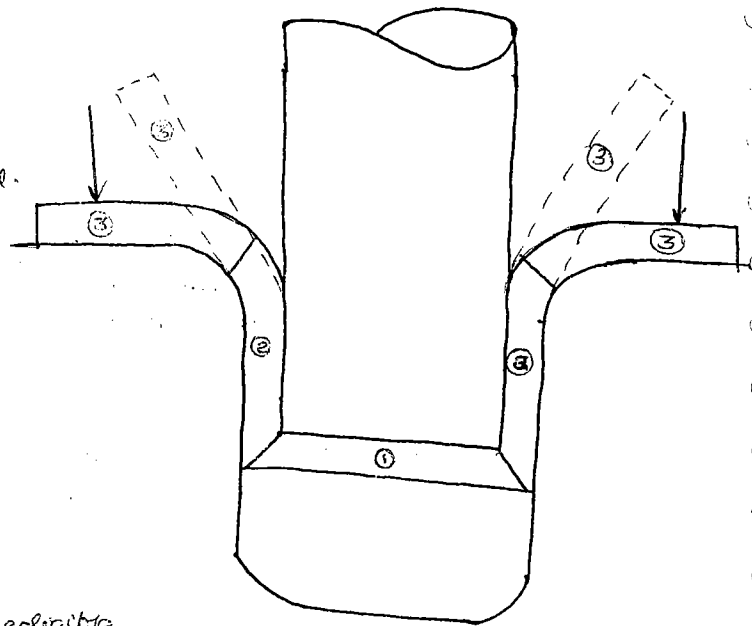

The stresses in the zone 2 alone is responsible for the deformation. So it is req. only to calculate the stresses induced in it.

During deep drawing operation; the tensile stresses induced in the deformation zone are only responsible for changing the shape of the component. It is required to calculate the magnitude of the stresses induced in the zone.

σ_{21} - stresses induced in zone 2 of stage 1

$$\begin{aligned}\sigma_{21} &= \frac{\text{load}}{\text{Area}} \\ &= \frac{P_1}{\frac{\pi}{4}(d_1^2 - (d_1 - 2t)^2)}\end{aligned}$$

Stress induced in zone 2 in stage 2

$$\sigma_{22} = \frac{P_2}{\frac{\pi}{4}(d_2^2 - (d_2 - 2t)^2)}$$

$$\sigma_{23} = \frac{P_3}{\frac{\pi}{4}(d_3^2 - (d_3 - 2t)^2)}$$

every where n zones $\Rightarrow \sigma_y < \sigma_{22} < \sigma_u$

Number of stages required

(i) Draw ratio method :-

Draw ratio

$$DR = \frac{\text{Dia before}}{\text{Dia After}}$$

$$DR_1 = \frac{D}{d_1}$$

$$DR_2 = \frac{d_1}{d_2}$$

$$DR_3 = \frac{d_2}{d_3}$$

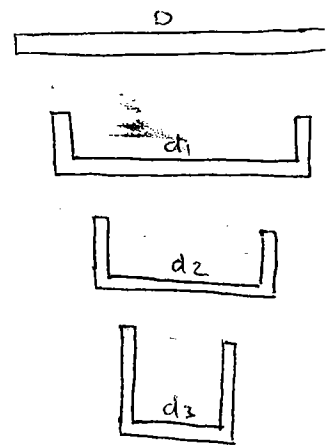

Limiting draw ratio,

$$\begin{aligned} LDR &= DR_1 = DR_2 = DR_3 = \dots \\ &= 1.6 - 2.3 \\ &= 1.6 - 2 \quad \text{Hard materials} \\ &= 2 - 2.3 \quad \text{Soft materials} \end{aligned}$$

$$DR_1 = \frac{D}{d_1} \Rightarrow d_1 = \frac{D}{DR_1} = \underline{\hspace{2cm}} \leq d, \quad n=1$$

if not

$$DR_1 = \frac{D}{d_2} \Rightarrow d_2 = \frac{d_1}{DR_2} = \underline{\hspace{2cm}} \leq d, \quad n=2$$

if not

$$DR_3 = \frac{D}{d_3} \Rightarrow d_3 = \frac{d_2}{DR_3} = \underline{\hspace{2cm}} \leq d, \quad n=3$$

if not

d - dia to be prod

Q

$d = 30 \text{ mm}$
 $h = 150 \text{ mm}$ } number of draws req
 $n = ?$

$DR_1 = 1.6$

$DR_2 \text{ and above} = 1.8$

blank dia $D = \sqrt{d^2 + 4dh}$
 $= \sqrt{30^2 + 4 \times 30 \times 150}$
 $= 137$

$\frac{DR_1 = D}{d_1} \quad d_1 = \frac{D}{DR_1} = \frac{137}{1.6} = 85 > 30$

$d_2 = \frac{85}{1.8} = 47 > 30$

$d_3 = \frac{47}{1.8} = 26 < 30 \quad \underline{\underline{n=3}}$

draws are required or drawing can be done in 3 stages.

2. Draw reduction ratio

$DRR = \frac{\text{dia reduced}}{\text{dia before}}$

$DRR_1 = \frac{D - d_1}{D}$

$DRR_2 = \frac{d_1 - d_2}{d_1}$

$DRR_3 = \frac{d_2 - d_3}{d_2}$

General values of DRR

$DRR_1 = 45 - 50\%$

$DRR_2 = 30 - 35\%$

$DRR_3 = 20 - 25\%$

$DRR_{4 \text{ above}} = 16\%$

No need to remember
 will be given as Exm.

$DRR_1 = \frac{D - d_1}{D}$

$d_1 = D(1 - DRR_1)$

$$d_1 = D(1 - \text{DRR}_1) \leq d, n=1$$

if not $d_2 = d_1(1 - \text{DRR}_2) \leq d, n=2$

if not $d_3 = d_2(1 - \text{DRR}_3) \leq d, n=3$

.....

Q

$$\left. \begin{aligned} d &= 30 \text{ mm} \\ h &= 150 \text{ mm} \end{aligned} \right\}$$

$$D = ?$$

$$\text{DRR}_1 = 40\%$$

$$\text{DRR}_2 \text{ \& above} = 25\%$$

$$D = \sqrt{d^2 + 4dh} = 137$$

$$d_1 = 137(1 - 0.4) = 82 > 30$$

$$d_2 = 82(1 - 0.25) = 62 > 30$$

$$d_3 = 62(1 - 0.25) = 46 > 30$$

$$d_4 = 46(1 - 0.25) = 34 > 30$$

$$d_5 = 34(1 - 0.25) = 26 < 30, n=5$$

If nothing is mentioned about the values of draw ratio or draw reduction ratio it is always assumed that the draw ratio method will $\text{LDR} = 2$.

Q If $d = 12 \text{ mm}$ & $h = 30 \text{ mm}$. Calculate $n = ?$

$$D = \sqrt{12^2 + 4 \times 12 \times 30} = 40 \text{ mm}$$

$$d_1 = \frac{D}{2} = \frac{40}{2} = 20 > 12$$

$$d_2 = \frac{d_1}{2} = \frac{20}{2} = 10 < 12, n=2$$

Defects in deep drawing

1. Wrinkling :-

The formation of wrinkles or foldings on the deep drawing component is called wrinkling. Wrinkling can be eliminated by

- (a) blank holder force (BHF)
- (b) By ironing -

Normally in the deep drawing operation; the clearance b/w the punch & die = sheet thickness, but for removing the wrinkles present in the deep drawing component the clearance present b/w the punch and die is made slightly less than the sheet thickness so that the squeezing of the material is taking place which removes the wrinkles present in the deep drawing component.

- (c) By using draw bead

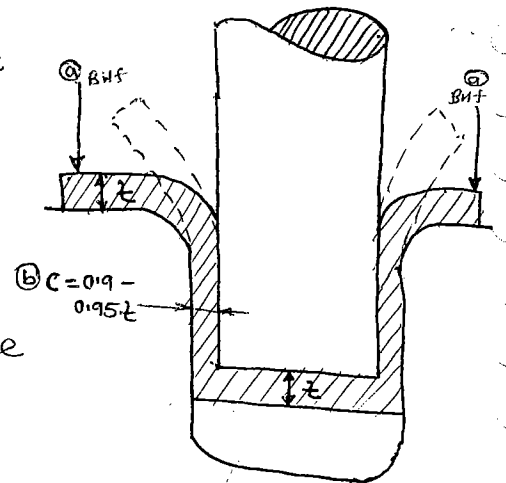

2. Earing :-

The presence of edge wrinkles or waviness present on the edges of a deep drawn component is called as earing defect.

This is produced mainly b/c of anisotropic properties of a sheet metal.

During deep drawing; when a wrinkle is forming on the component, at the inside surface of a wrinkle, compressive; outer surface of a wrinkle - tensile stresses are induced. but the magnitude of compressive and tensile stresses are different.

The amount of work hardening taking place in the sheet metal is different in different directions. Due to this; the material has got converted from the isotropic to the anisotropic.

elimination :-

Complete elimination of ~~the~~ earing defect is not possible. but it can be minimized by using the draw bead.

Semi-circular strip provided around the circumference of a circular die blank holder is called draw bead. It has a dia of 13-20mm.

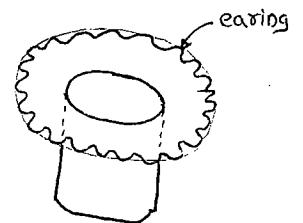

$$\text{Number of ears or waves} = 2^n$$

where $n = \text{an integer}$
1, 2, 3, 4, ...

in multiple choice question would be given in such a way that only powers of 2 will be given
2, 4, 8, 16, 32, 64, 128, 256, ...

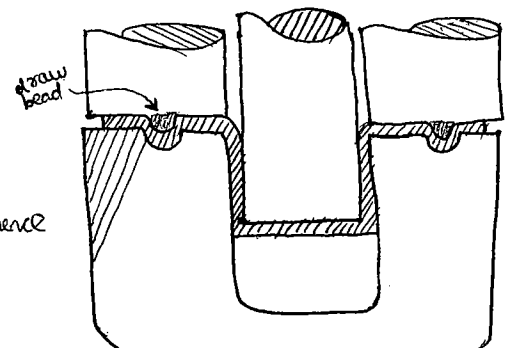

by using draw bead, the sheet metal is experiencing diff. types of stresses at diff. locations [compressive & tensile] \therefore the amount of workhardening in the sheet is nearly uniform.

\therefore the properties of the sheet metal becomes nearly uniform which minimizes the formation of earings.

As the earing defect can't be completely eliminated it can be removed by trimming or edge trimming operation.

due to edge trimming operation - the dimensions of a deep drawing operations will be reduced, to maintain required dimensions of a component; the original blank size has to be increased.

effect of draw bead

- (1) wrinkling is eliminated
- (2) Earing is minimised
- (3) BHf is reduced
- (4) Drawing load is more

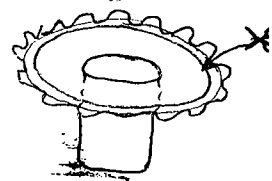

$$D_{total} = D + 2 \times T \cdot A$$

T.A - trim allow

4 Bending

Bending is also the forming operation & forces induced in the sheets will produce the stresses greater than yield & less than the ultimate ($\sigma_y < \sigma < \sigma_u$).

eg:- drawing board, window frames, tubelight frame, fence etc.

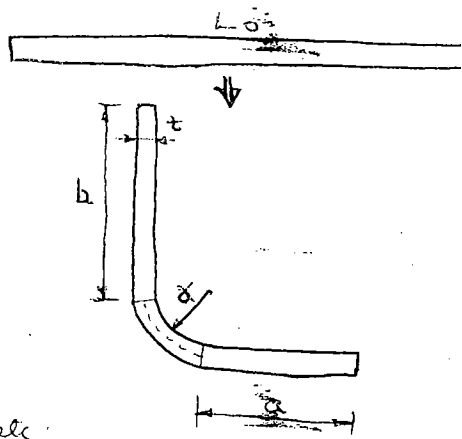

L_0 - developed length of sheet or original length of the flat starting strip.

$$L_0 = a + b + B$$

from the simple bending theory

$$\frac{M}{I} = \frac{\sigma}{y} = \frac{E}{R} \rightarrow \sigma_n$$

but we are not going that way.

Simply

$$\sigma_n = \sigma + Kt$$

K - bend factor = stretch factor

$$= \frac{1}{3} \quad \text{if } r < 2t$$

$$= \frac{1}{2} \quad \text{if } r \geq 2t$$

θ = bend angle in radians

B - bend allowance

[original flat strip required for produce the bent portion of component]

= arc length of neutral plane

$$B = \sigma_n \times \theta$$

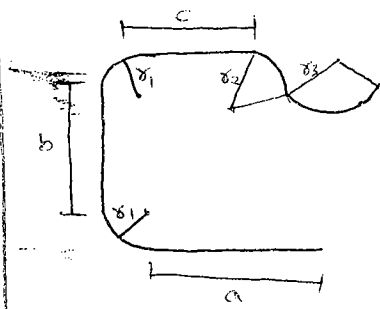

$$L_0 = a + b + c + 2B_1 + B_2 + B_3$$

Force required

$$F = \frac{C L_0 \sigma_y t^2}{w} \text{ Newton}$$

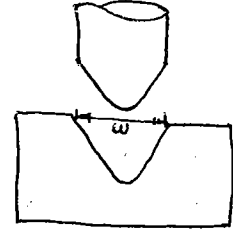

w - width of die opening = $8t$ or $16t$

σ_y - Yield stress of material

t - thickness of strip

C - die opening factor

$$= 1.2 \text{ if } w = 16t$$

$$= 1.33 \text{ if } w = 8t$$

Types of bending

1. U-bending

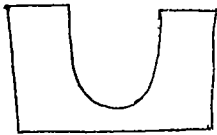

Shape of die is Ushaped

2. V bending

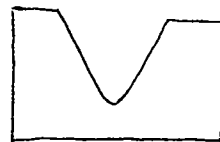

Shape of die is Vshaped

3. Edge bending

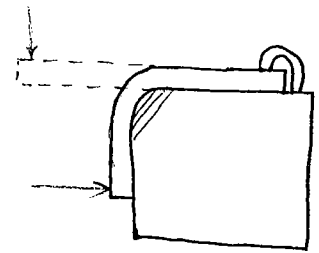

If edge of die is been used for bending

If a given component is possible to produce by using all the 3 methods of bending, the force required for U bending is largest and edge bending is smallest and V-bending is in b/w.

$$\text{force req. :- } U : V : \text{Edge} = 2 : 1 : 0.5$$

Let δ_{min} is the minimum radius to which the sheets can be bent, without producing the cracks on the outer surface of a bent portion.

$$\delta_{min} = t \left[\frac{50}{a} - 1 \right]$$

a-% reduction in area at the time of fracture during tensile testing.



50% is the maximum % of reduction obtained in any material, (Al, Cu, mild steel) etc (very soft materials) are given 50%. No material will have more than 50% reduction in area.

$$\text{So } \delta_{min} = t \left[\frac{50}{50} - 1 \right]$$

$$\delta_{min} = 0$$

but for most of other metals $a = 14.5\%$ - titanium

$$\delta_{min} = t \left[\frac{50}{14.5} - 1 \right] = 2.5t$$

Spring back :-

Due to presence of elastic deformation in the material, after withdrawing the load from the component, some amount of its regaining of original shape will be taking place. This is called as spring back in bending.

This is indicated by using the ratio

$$\frac{R_f}{R_i}$$

$$\text{If } \frac{R_f}{R_i} = 1 \Rightarrow \text{Spring back} = 0$$

As the $\frac{R_f}{R_i}$ is increasing the spring back in bending is increased.

$$\frac{R_f}{R_i} = 4 \left(\frac{R_i \sigma_y}{E \cdot t} \right) - 3 \left(\frac{R_i}{EK} \right) + 1$$

S.B depends on

R_i/t - Geometrical factor

σ_y

E - Young's modulus

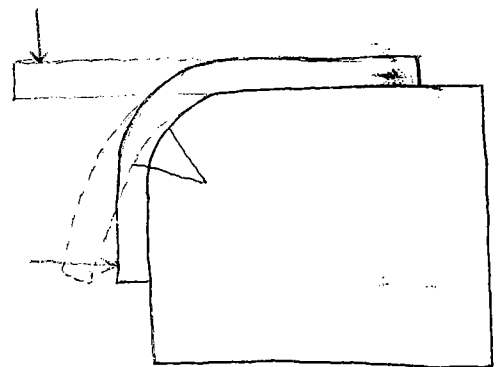

CPo minimize S.B

$R/2 \downarrow$

$\sigma_y \downarrow$

$E \uparrow$

Minor operations

(1) Perforating

The operation of producing many number of smaller size of the holes in the sheet is called perforating.

Mainly used for manufacture of sheaves.

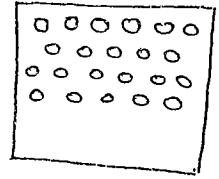

(2) Notching

The method of removing a piece of material from the edge of the sheet is called as Notching.



(3) Lancing :-

The method of producing an incomplete hole or blank at the center of the sheet

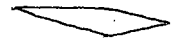

(4) Slitting :-

Method of producing an incomplete hole or blank at the edge of the sheet is called slitting

(5) Nibbling :-

Method of producing a large size hole by using small size punch in many No. of repetitive strokes

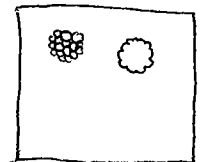

(6) Trimming :-

Method of removing small amount of material from complete circumference of a component is called trimming operation.

Types of dies in sheet metal operation

1. Simple die :-

If only one operation is performed in one stroke at one stage is called as simple die

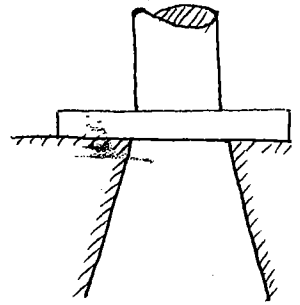

2. Compound die :-

If more than one cutting operation is performed at one stroke at one stage is called compound die

eg :-

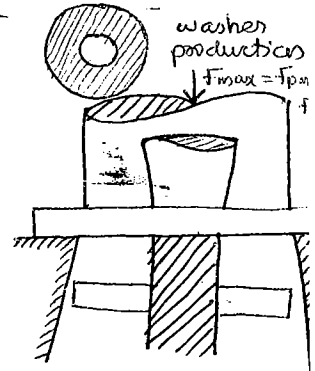

Advantage of compound die is that one component could be produced per stroke. \therefore the production rate is high.

The force required is very high and both the methods of reducing the force required cannot be used for reducing the force req. in punching or blanking.

If the number of operations to be performed is greater than 3, the design and manufacturing of punch and die combination for compound die is very difficult.

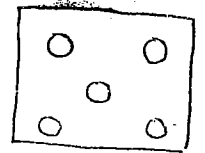

3. Progressive die :-

In this die also more than one cutting operation is performed in one stroke; but at different stages so that the punched out sheet is progressing from one stage to another stage for completing the punching operations and blanking will be the last operation.

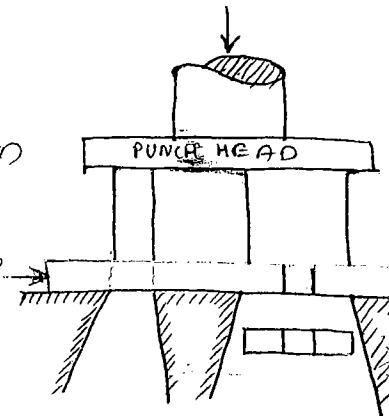

with progressive die

- (1) one component will be produced per stroke. \therefore the production rate is same as that of the compound die
- (2) Bcz, the operations are performed at different stages; it is possible to stagger the punches or provide the stagger on the punch or die. Hence the force required for punching or blanking operation, can be reduced
- (3) Bcz of more than one stage, the design and manufacturing of punch & die combination is easier.

Limitation of the progressive die is that the balancing of forces on the punch head is difficult.

4) Transverse die

In transverse die, more than one cutting operation is performed in one stroke at different stages but the blanking will be the 1st operation so that the blank produced in the 1st stage is travelling from one to the another stage for completing remaining punching operation.

Among the transverse and progressive die

5) Combination die :-

If more than one cutting and forming operations are performed in one stroke at one stage, is called as combination die.

In combination die, the blanking and deepdrawings or blanking & bending or punching and deepdrawings etc can be combined together.

6) Multiple die :-

In all the above dies only one component will be produced ~~per~~ stroke. But to produce more than one component per stroke - more than one of the above dies will be kept in parallel; called as multiple dies. i.e. for producing 10 washers per stroke 10 compound dies or 10 progressive dies will be kept in parallel.

p.35
Q.1

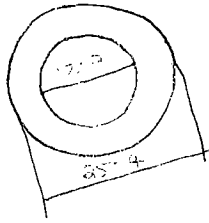

Punching

$$\begin{aligned}
 HS &= 12.7 \\
 PS &= HS - (2.7) \\
 DS &= PS + 2C \\
 &= 12.7 + 2 \times 0.09 \\
 &=
 \end{aligned}$$

$$D = \frac{L}{S} = \frac{220}{54} \times 2 = 8.1$$

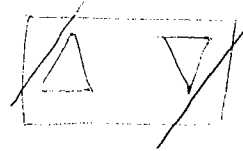

2 half of blank
there in cut
to waste

Blanking

$$\begin{aligned}
 BS &= 25.4 \\
 DS &= BS = 25.4 \\
 PS &= DS - 2C = 25.4 - 2 \times 0.09 \\
 &=
 \end{aligned}$$

$$F_{max} = F_{pmax} + f_{bmax}$$

$$= \pi d_p t \tau_c + \pi d_b t \tau_c$$

$$= (\pi \times 12.7 \times 1.25 \times 800) + (\pi \times 25.4 \times 1.25 \times 800)$$

$$= 40 + 80 = \underline{120 \text{ kN}}$$

with progressive dies

$$F_{max} = \max(F_{pmax}, f_{bmax})$$

$$= \max(40, 80)$$

$$= \underline{80 \text{ kN}}$$

$$F(Kt+I) = f_{max} K t$$

$$F = \frac{120 \times 0.6 \times 1.25}{0.6 \times 1.25 + 1}$$

$$= \underline{51.5 \text{ kN}}$$

Q.2

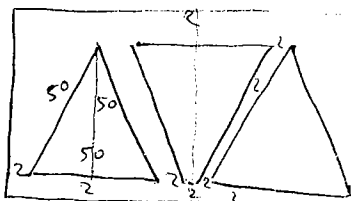

$$\frac{\sqrt{3}}{4} \times 50^2 + \frac{1}{2} \frac{\sqrt{3}}{4} \times 50^2 = \frac{3}{2} \frac{\sqrt{3}}{4} 50^2$$

$$54 \times \sqrt{50^2 - 25^2} = 2238.268$$

Q.8

$$\begin{aligned}
 f_{bmax} &= P t \tau_c \\
 &= 317.5 \times 1 \times 420 \\
 &= 133.3 \text{ kN}
 \end{aligned}$$

$$\begin{aligned}
 F_{pmax} &= \pi d t \tau_c \times 2 \\
 &= \pi \times 12.5 \times 1 \times 420 \times 2 \\
 &= 32.9 \text{ kN}
 \end{aligned}$$

Q.9

$$R_c = 98 + 184 + 92 + B_1 + 2B_2$$

$$B_1 = \left(15 + \frac{1}{2} \times 2\right) 180 \times \frac{\pi}{180} = 16\pi$$

$$B_2 = \left(6 + \frac{1}{2} \times 2\right) 90 \times \frac{\pi}{180} = 7 \times \frac{\pi}{2}$$

Q.10

$$\begin{aligned}
 D &= \sqrt{d^2 + 4dh} \\
 &= \sqrt{5^2 + 4 \times 50 \times 5}
 \end{aligned}$$

$$DR_1 = 1.8 = \frac{D}{d_1} = d_1 = \frac{13.2}{1.8} = 7.3$$

$$DR_2 = 1.8 = \frac{d_1}{d_2} = \frac{7.3}{1.8} = 4.0 < 5$$

$$P_d = \pi d_1 t \sigma_y \times \frac{D}{d_1}$$

$$= \pi D^2 \sigma_y$$

$$\varphi_{wD} = P_d \times h =$$

Q11

$$P = 50 + 100 + 30 + 2 \times 52 + 80$$

$$F_{max} = P \times \tau_u$$

$$= P \times 2 \times 145$$

$$= \underline{83.5 \text{ kN}}$$

$$w \cdot D = f_{max} \times K \tau$$

$$= 83.6 \times 10^3 \times 0.4 \times 2 \times 10^{-3}$$

$$\approx 66. \text{ J}$$

$$F(k\tau + I) = f_{max} \times K \tau$$

$$I = \frac{f_{max} K \tau - k\tau}{f}$$

$$= \frac{83.6 \times 0.4 \times 2 - 0.4 \times 2}{24}$$

2

Q18

$$0.4 = \frac{D - d_1}{D} \Rightarrow d_1 = D(1 - 0.4) = 30 \times 0.6 = 18 > 12$$

$$0.25 = \frac{d_1 - d_2}{d_1} \Rightarrow d_2 = d_1(1 - 0.25) = 18 \times 0.75 = 13.5 > 12$$

$$d_3 = d_2(1 - 0.35) = 12 \times 0.35 = 10 < 12$$

$$n = \underline{3}$$

Q17

$$D_1 = \pi D t \sigma_y = \pi \times 30 \times 2 \times 2 \times 35$$

=

$$G_{21} = \frac{P_1}{\pi/4 (d_1^2 - (d_1 - 2r)^2)}$$

2

Q19

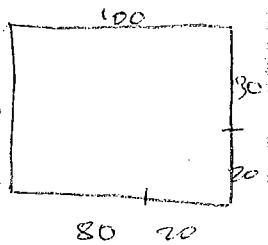

$$d = 30$$

$$h = 150$$

$$D = \sqrt{d^2 + 4db} = 137.$$

DR dia after dia before

$$DR_1 = \frac{d_1}{D} = d_1 = 0.6 \times D = 82 > 30$$

$$d_2 = 0.8 d_1 = 65 > 30$$

$$d_3 > 0.8 \times d_2 = 54 > 30$$

$$d_4 > 0.8 d_3 = 42 > 30$$

$$d_5 > 0.8 \times d_4 = 33 > 30$$

$$d_6 > 0.8 \times d_5 = 27 < 30$$

$$n = \underline{6}$$

Q21

$$\frac{d}{r} = \frac{100}{6} = 16.6 = 15 - 20.$$

$$D = \sqrt{d^2 + 4db} = \frac{8}{2}$$

$$D_{total} = D + 2 \times T \cdot A$$

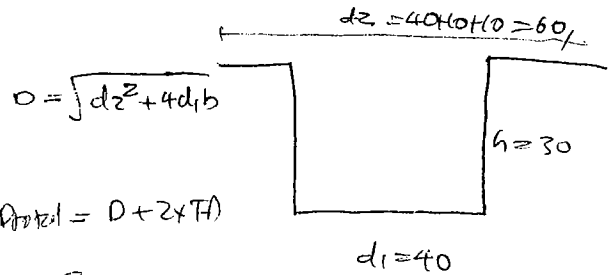

$$D = \sqrt{d_2^2 + 4db}$$

$$D_{total} = D + 2 \times T \cdot A$$

2

Q23

$$F(k\tau + I) = f_{max} k\tau$$

$$F = \frac{f_{max} k\tau}{(k\tau + I)}$$

$$= \frac{f_{max}}{3}$$

$$D = \sqrt{d^2 + 4db} = \sqrt{5^2 + 4 \times 6 \times 10} = 15$$

$$LDR = 2$$

$$d_1 = \frac{D}{DR} = \frac{5}{2} = 2.5 > 5$$

$$d_2 = \frac{d_1}{DR_2} = \frac{2.5}{2} = 1.25 < 5, \quad n = 2$$

Q.26

(B) Q & R.

Q.27

(B)

Q.28

$$T_f = \pi d t \tau_u$$

$$= \pi \times 1.5 \times 0.4 \times \tau_u$$

$$= \pi \times 0.6 \times \tau_u \quad (1.5 \times 0.4)$$

$$= 5 \times 0.6 = \underline{\underline{3 \text{ kN}}}$$

Q.29

$$BS = 35$$

$$PS = BS = 35$$

$$PS = PS - 2C$$

$$= 35 - 2 \times 0.06$$

$$= \underline{\underline{34.92}}$$

Q.30

$$F_{max} = P \times Z \times \tau_u$$

$$= 200 \times 5 \times 100$$

$$= \underline{\underline{10 \text{ kN}}}$$

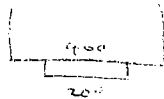

$$W.D = F_{max} \times Z$$

$$= 100 \times 10^3 \times 0.2 \times 5 \times 10^{-3}$$

$$= \underline{\underline{100 \text{ J}}}$$

Q.31

$$400 - 200$$

$$200 - \frac{20}{400} \times 200 = 10 = 2$$

$$F = \frac{F_{max} \times k t}{k t + 1} = \frac{100 \times 0.2 \times 5}{0.2 \times 5 + 1} = 110$$

Q.33

301

Q.35

(A)

Q.36

Am (B)

$$CT = 8 - 20^\circ \text{ after TDC}$$

$$5 - 15^\circ \text{ after TDC}$$

Q.37

(D)

$$BS = 30$$

$$PS = 30$$

$$PS = 30 - 2 \times C$$

$$= 30 - 2 \times \frac{0.06}{100}$$

$$= \underline{\underline{29.8}}$$

Q.38

14.88



It's not a

$$PS = 20 - 2 \times 0.06$$

$$= \underline{\underline{19.88}}$$

giving option
like to prod
by 6.6k, me.

Q.39

$$TA = \frac{2}{25} \times 48.5 =$$

$$\frac{48.5}{1.5} = 32 > 20$$

$$W = \sqrt{d^2 + 4d^2}$$

$$D_{total} = D + 2 \times T \cdot A$$

$$= 120.5$$

Q
40

50%

Q
41

τ_{cr} = shear stress

Q
42

$$A_{max} = 37.7 \text{ kN}$$

$$I = 2$$

$$F = 14.3 \text{ kN}$$

Q
43

$$B = \sigma_0 \theta$$

$$= (\sigma + kI) \theta$$

$$= (100 + 0.5 \times 2) \theta$$

$$= \underline{\underline{101}}$$

4. MACHINING

$$\text{No. of pieces} = \frac{1000}{\text{time/piece}} = \frac{4}{2}$$

Q.1

$$\begin{aligned} \text{Time/hole} &= \frac{L}{fN} = \frac{L + AP_1}{fN} \\ &= \frac{L + 0.5}{fN} \\ &= \frac{25}{0.25 \times 300} = \frac{1}{3} = 20 \text{ sec} \end{aligned}$$

Q.7

$$\begin{aligned} \text{Total depth} &= \text{acceleration} + \text{deceleration} \\ &= 10 + 10 \\ &= 20 \text{ mm} \\ &= 2.25 \times 3 = \underline{6.75 \text{ mm}} \end{aligned}$$

Q.2

$$\begin{aligned} \text{Time/cut} &= \frac{B}{f} \cdot \frac{L}{V} (1 + M) \\ &= \frac{300}{0.3} \times \frac{1}{10} = 100 \text{ min} \end{aligned}$$

Q.8

$$\begin{aligned} d &= AP_1 = 0.5D \\ &= 0.5 \times 20 = \underline{10 \text{ mm}} \end{aligned}$$

Q.3

$$\begin{aligned} \text{speed range ratio} &= \frac{V_{\text{max}}}{V_{\text{min}}} = \frac{D_{\text{max}}}{D_{\text{min}}} = \frac{120 \times 25}{40 \times 5} \\ &= \frac{25}{1} \end{aligned}$$

$$\text{tapering/mm} = \frac{10 - 7.5}{2 \times 80} = \frac{x}{80}$$

Q.4

$$\text{high spots/sec} = \frac{360}{30} = 12$$

$$\begin{aligned} \text{high spots/sec} &= \text{high speed/sec} \times \text{RPS} \\ &= 12 \times \frac{500}{60} = 100 \text{ high spots/sec} \end{aligned}$$

Q.10

$$\begin{aligned} \text{offset} &= \text{Total tapering} \\ &= \text{Taper/mm} \times \text{Total length} \\ &= \left(\frac{10 - 7.5}{2 \times 80} \right) \times 180 = \end{aligned}$$

Q.5

$$\text{GR} = \frac{\text{metal removed on wp}}{\text{Grinding wheel}} = \frac{200 \times 2.5 \times 5}{\frac{\pi}{4} (D_1^2 - D_2^2) L}$$

$$\begin{aligned} D_1 &= 300 \\ D_2 &= 300 - 2 \times 0.02 \\ &= 299.96 \end{aligned}$$

$$\frac{\pi}{4} (300^2 - (299.96)^2) \times 2.5 = 200 \times 2.5 \times 5$$

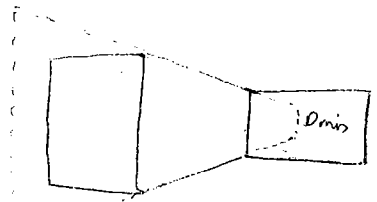

Q.6

$$T = 1000 \text{ sec}$$

$$V_c = 0.5 \text{ m/sec}$$

$$\begin{aligned} \text{Time/piece} &= \frac{L}{fN} \\ &= \frac{80}{0.1 \times 1000 \times 0.5} \end{aligned}$$

Q.11

$$P = 15 \text{ kW}$$

$$\phi_{20} = \phi_{26} \text{ mm}$$

$$h = 0.0075$$

$$p = 10$$

$$V_c = 0.5 \text{ m/min}$$

depth of median removal
 $d = \frac{26-20}{2} = 3 \text{ mm}$

$$D = \frac{d}{h} = \frac{3}{0.0075} = 400$$

$$L_e = D \times P$$

$$L = L_e + z \cdot d = L_e + 25$$

$$\text{time} = \frac{L}{V} = \frac{L}{500} =$$

Q.13

RPM work = No. of D_s /min

$$= \frac{V}{L(1+m)}$$

$$= \frac{18000}{200(1+2/3)}$$

Q.13

$$M = 1/2$$

$$L = 2 \text{ m}$$

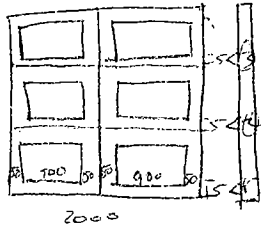

$$B = 300 + 5 + 5$$

$$= 310$$

$$\text{Time/out} = \frac{B}{f} \cdot \frac{L}{V} (1+M)$$

$$= \frac{310}{1} \times \frac{2000}{1000} (1 + \frac{1}{2})$$

$$= 930 \text{ sec}$$

$$\text{Time/pc} = \frac{930}{2} = 465 \text{ sec}$$

Q.14

$$L_e = L_n \times L_B + L_f$$

$$L_n = 8 \times 20 = 160$$

$$L_f = 4 \times 20 = 80$$

$$d = d_s + d_{ds} + d_{ds} = 4.5$$

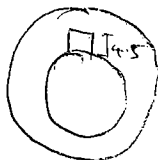

$$d_s = d - (d_s + d_s)$$

$$= 4.5 - (8 \times 0.0125 + 4 \times 0)$$

$$= 4.4$$

$$n_s = \frac{d_s}{h_s} = \frac{4.4}{0.1} = 44$$

$$L_s = n_s \times P_s$$

$$= 44 \times 22$$

$$= 968$$

Q

$$AP_i = \frac{1}{2} (D - \sqrt{D^2 - W^2})$$

$$= \frac{1}{2} (100 - \sqrt{100^2 - 80^2})$$

$$\text{Time/out} = \frac{1}{fN} = \frac{D + AP_i \times AP_o \times OR}{f \times z \times t \times N}$$

$$= \frac{2 \times 200 \times AP_i + 5 + 5}{0.1 \times 12 \times \frac{1000 \times 50}{\pi \times 100}}$$

=

Q

asymmetrical

$$W_i = W + 2 \times 0.5$$

$$= 80 + 2 \times 5 = 90$$

$$AP_i = \frac{1}{2} (100 - \sqrt{100^2 - 90^2})$$

$$\text{Time/out} = \frac{D + AP_i + AP_o \times OR}{f \times z \times t \times N}$$

Q.16

R.H \rightarrow Direction of rotation of job & L.S is same

Compound GT, $\frac{q}{s} = \frac{C}{t} \rightarrow$ Sim dir to - No filler or exp idler

L.H \rightarrow opp dir - compound GT \Rightarrow same

Wk 1,3,5 - odd No of idler - (A) (B) gear size not correct

2

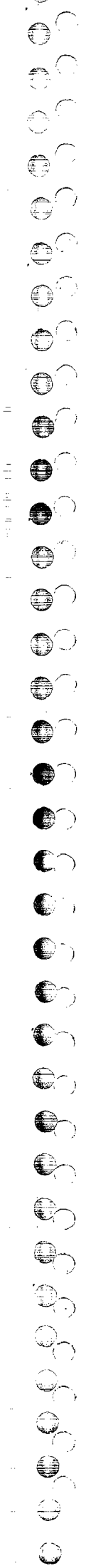

Limitation of Normal machining methods :-

In the normal machining method, the accuracy of components produced depend on the efficiency of operators.

Consistency in manufacturing is not possible

Manufacturing of complex shapes of the components is not possible.

Bez of lot of man power is involved, the labour law problem will be present

Frequent design changes of the component can't be incorporated in the existing manufacturing system.

Bez of inconsistency in manufacturing, 100% inspection of the component is required. Therefore cost of inspection is increasing

NC machine [Numerically control]

If each and every axis is controlled by using numbers or numerals; called as numerically controlled m/c tool.

Basic Parts :-

1. MCU (m/c control unit) or CPU (central processing unit)
2. Drive unit (DU) (G/P)
3. Feed back device (FBD) (I/P)
4. Tape Reader system (TRS) (G/P)
5. Manual controls (MC) (G/P)

1. MCU

MCU is working like a brain of the human being. It is taking the input information from the input devices available in the NC machine like tape reader system (TOS), feed back device (FBD) etc; analysing the data and taking the decisions. The decisions taken by the MCU will be implemented by using the output devices available in the NC machine.

The machine can only understand the low level language, i.e. the binary system. But when human being is given the input information in the form of decimal, to convert the decimal to the binary and vice versa, a unit is required in the MCU called as arithmetic logic unit which is a part of the MCU.

2. Drive unit (O/P)

Drive unit is an energy conversion device; this is taking the input information from the MCU in the form of electrical energy or electrical signals and converting into the mechanical energy required for travelling the axis to the destination.

The drive unit used in NC machine is the electrical motor. The major type of motors used are:-

- (1) Induction motor X
- (2) Stepper motor
- (3) Servo motor

By the induction motor is rotating at only one particular rpm, i.e. the designed rpm, it is not possible to use as a drive unit in the NC machine.

Stepper motor is taking the input as pulsed electrical energy and produce mechanical energy in the form of rotations. Either by changing the no. of pulses of electrical energy input or by changing the rate of pulses of electrical energy input, it is possible to vary the rpm of the motor. This is used as a drive unit in the NC machine.

Servomotor is also working like a stepper motor i.e. it is taking the pulsed electrical energy as input and produce variable speed of a motor. In addition, the servomotor also consists of quick action breaking system, so that whenever the power supply is stopped to the motor, the breaking system will be activated immediately and stop the motor and axis immediately without any over travelling. \therefore high positional accuracies are possible.

By the time, the NC machines were developed, the servomotors were not developed. \therefore Only stepper motors are used as a drive unit in the NC machine.

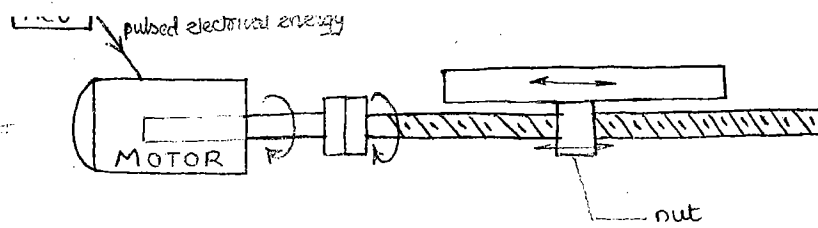

eg:-

200 pulses \rightarrow 1 rev of motor
 \rightarrow 1 rev of lead screw
 \rightarrow 1 pitch or 1 lead
 \rightarrow 5 mm

200 pulse \rightarrow 5 mm

1 pulse $\rightarrow \frac{5}{200} = \frac{1}{40} = 0.025 \text{ mm} = 1 \text{ BLU} = \text{Positional accuracy}$
 \uparrow
 basic Length Unit

200 pulse \rightarrow 5 mm

1 mm $\rightarrow \frac{200}{5} = 40 \text{ pulse}$

50 mm $\rightarrow 40 \times 50 = 2000 \text{ pulse}$

3. Feed back device :-

It is a displacement measuring equipment mounted on the axis of a machine so that it measures the actual distance travelled by the axis and sending it as a feed back to the MCU. The MCU will calculate the difference in the distance i.e. it compares the actual distance travelled by the axis with distance to be travelled by the axis. Corresponding to this difference in the distance, the MCU will generate the electrical energy pulses and send it to the drive unit. The drive unit will again generate the mechanical energy required for travelling the remaining distance. Again FBD measures the actual distance and send them to MCU. This process continue until the difference in the distance become $\leq 1 \text{ BLU}$.

The displacement measuring equipments which are giving the displacement of in the form of electrical energy can be used as feed back device.

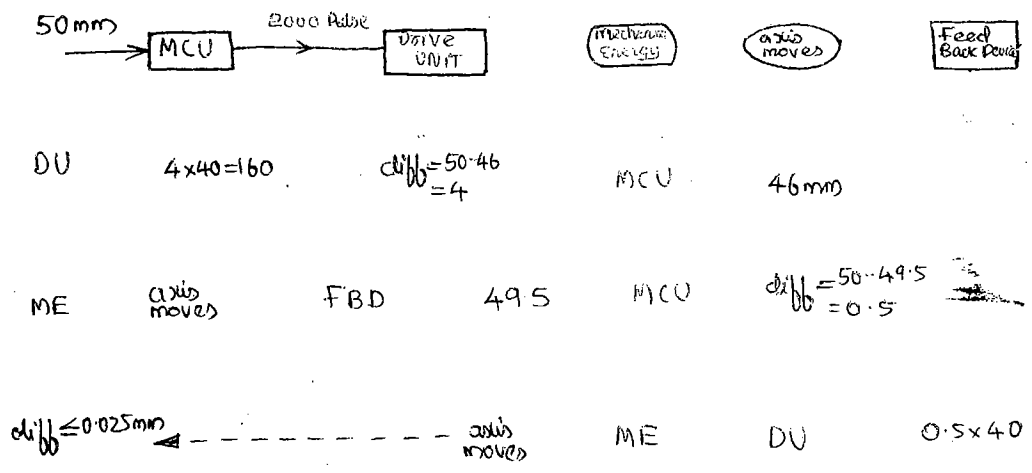

The different feed back devices used in the NC machine in the increasing order of the accuracy:

order of mm
 Potentiometer, LVDT, capacitance transducer, Inductance transducers, Resolvers, Synchros, Inductosyn, tachogenerator, tachometer, Encoder.

↳ order of nanometers

Tape reader System

It's a device used for transferring of the ideas available in the human brain into the machine tool.

punched taper tape.

1" punch paper tape

- Track 1 to 4 - Alphabets
- 5 - parity check
- 6 and 7 - Numbers
- 8 - EOB

- Track 1 - N (block No)
- 2 - X-axis
- 3 - Y-axis
- 4 - Z-axis

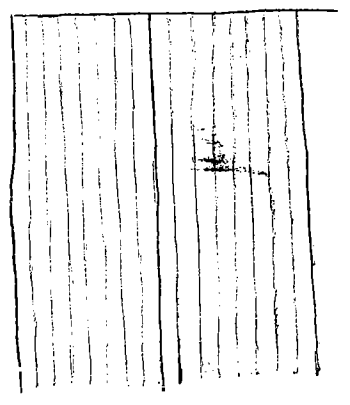
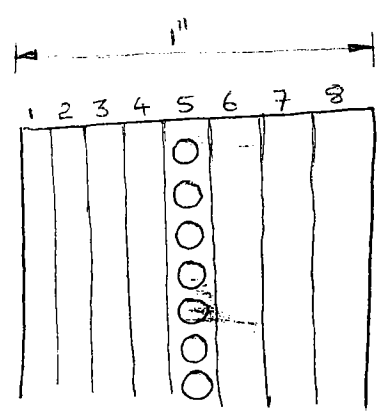

one block of information in NC program indicates that one complete instruction will be given to the machine for travelling the axis from present position to the next

N15 X50 Y30 Lf

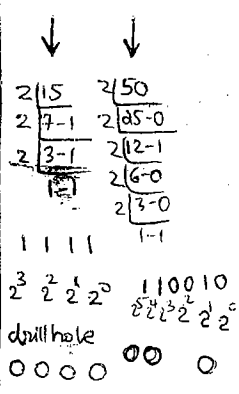

↳ line feed
or
EOB
or
;

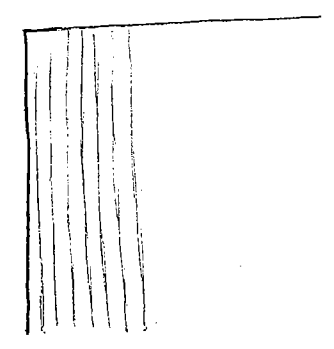
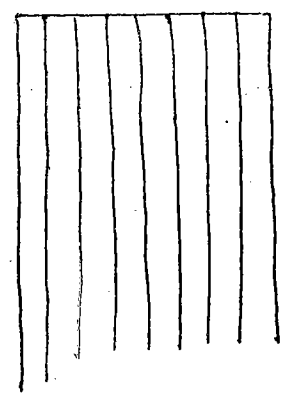

Tape reading

Total 21 readable tracks are there. Corresponding to this 21 track we provide light receiving sensors.

The punched tape is loaded on to the tape reader system. In tape reader system; one side of the tape, the light source is present and other side of the tape, the 21 numbers of light receiving sensors are provided corresponding to the 21 readable tracks on the tape. Whenever the tape is moving and stopping at some location, wherever the holes are there, through the holes, the light is passing and incident on the light receiving sensors. Whenever the sensor is receiving the light; it is generating the electrical energy and sending it to the mcu; the corresponding positions will be assumed as 'one' as the 1 by the mcu and the other positions will be taken as '0'.

Manual Control

Even though the above parts are present to the NC machine, still manual intervention is required for switching on and off the machine, loading and unloading of the work piece, loading and unloading of the tape, winding and unwinding of the tape etc.

Classification of NC machine

based on the control system used

- (a) PTP control System
- (b) Straight line control System
- (c) Contour control System

based on the feed back device used

- (a) Open loop system
- (b) Closed loop system

based on the number of simultaneous axis used

- (a) 2-D, $2\frac{1}{2}$ D, 3D, 4D, 11D

Point to Point Control System :-

In the movement of tool ; if only the end points are only important but the path followed by the tool in b/w the end points is not important called as point to point control system

It is used in the case of drilling, reaming, tapping etc.

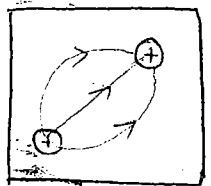

Straight line control system

In addition to the end points of the movement of the tool ; if the path followed by the tool in b/w the end points is a straight line path ; called as straight line control system

It is used in case of turning, milling, shaping, grinding etc.

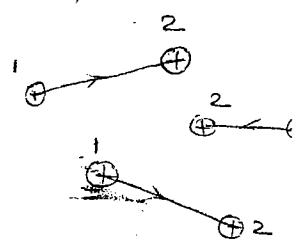

Contour Control System

In addition to the endpoints of movement of the tool ; if the path followed by the tool is b/w the end points is a contour path called as contour control system

It is used in case of turning, milling, grinding etc.

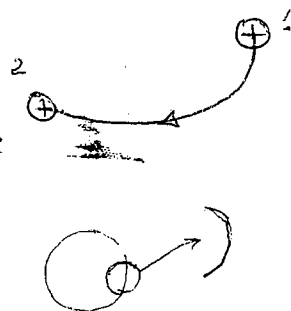

No advanced system will give the perfect contour but the smoothness of the contour depends on the interpolation parameters used in writing of the program

I-x } interpolation parameters
J-y }
K-z }

The maximum distance b/w two consecutive points on a contour is called interpolation parameter. This value varies from 0.001 to 999.999 mm

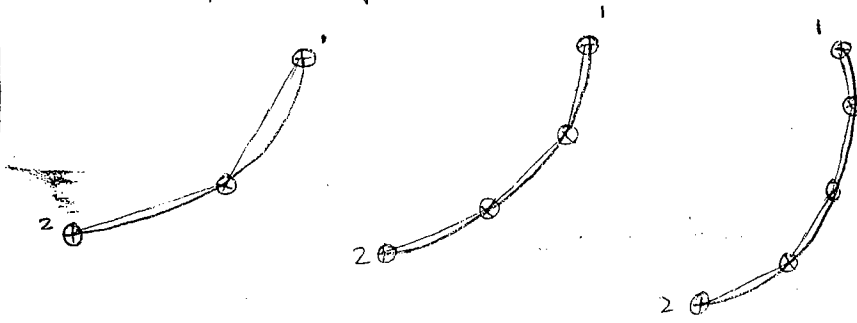

As the interpolation parameter is reducing; the time taken for manufacturing of a component is increasing. Hence the cost of manufacturing increases.

~~NC~~
Open loop system:-

NC machine without the use of feed back device is called open loop system.

Open loop system is a unstable system and the accuracy of the components produced is very poor.

The NC machine with the use of feed back device is called closed loop system. It is a stable system and produces accurate components.

based on the No: of simultaneous axis used.

If two axis of one tool can travel simultaneously; for removing material from the work piece, by taking the rotation of the job as a spindle. It is called as 2D machining. The spindle is nothing but the rotation of the job is constant. In another cut; the rotation can be varied.

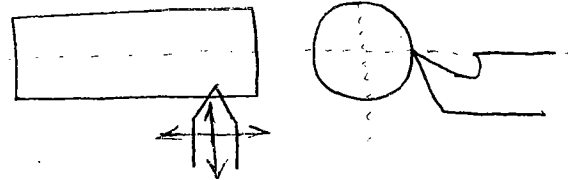

- In addition to the two axis of one tool; if the rotation of job also can be varied in a given cut, called as 3D machining.

If 2 axis each of the two tools can be varied simultaneously by taking the rotation of the job as a spindle; called as 4D machine tool.

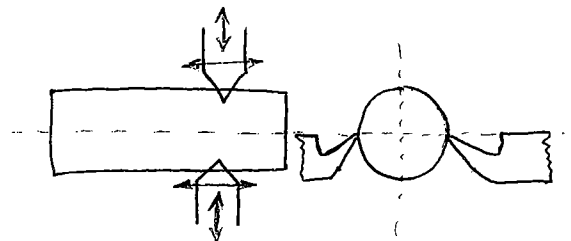

If 5 tools are removing the material simultaneously from one work piece by considering the rotation of job as a axis called as 11D machine tool.

latest NC - 840D - they have a capability to control 64 axis independently but it can only control 11D simultaneously. [CNC Systems is developed only by] FANUC and SIEMENS

64 D refers that 32 tools are there. 16 on one side and 16 on other.
 64 independent D means if X30 Y50 we provide. Then it is difficult impen to refer which tool to be moved; if 32 Ds provided. So we duplicate the axis. ie instead of X, Y, Z, we provide X1, Y1, Z1, X2, Y2, Z2 ... etc. each correspond each tool. Thus for 32 tool - 64 axis. Independently we could move 64 axis but simultaneous only 11 is possible.

every axis movement is controlled by using a vector. If we want to use 5 axis simultaneous refer that 5 vectors would be added, subtracted, multiplied. But only 11 vector operation simultaneously could be solved in maths. Thus only 11 D machines are provided.

9-D m/c - only one available in India. [BHEL Hyderabad] imported before 1988
 1989 - Agri-tested.
 Samsung in position - Not
 6-D - 8 machines available - 1998 - 1999 - Poland test.
 in India. again 3-D imposition

2 1/2 D means that programmable movement is possible along 3 axis. But simultaneous movement is possible along two axis only.

to produce cylindrical cams - we use this.

During manufacturing of the cylindrical cams; the variable rotation of the job is possible upto a maximum of 180° in one setting.

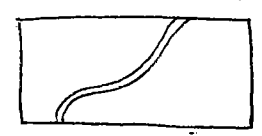

∴ the name is given as a 2 1/2 D axis.

Limitations of NC machines

- (1) Preparation of punched paper tape is very difficult and time consuming.
- (2) The punched paper tape can be used for producing a few nos. of components only.
- (3) No design modifications of a component cannot be incorporated in the existing tape.
- (4) Unless one component is manufactured physically, it is not possible to know whether the program written is correct or not, tape preparation is correct or not etc.
- (5) Bcz of use of positional stepper motors, high positional accuracies cannot be not possible.
- (6) Bcz of many of the manual controls are present, complete automation or mechanization is not possible.

To overcome these limitations of NC machine, the next development is CNC

CNC machine tool - Computer Numerical Control machine tool

Components

MCU

DU [servo motor]

FBD

~~TXS~~ completely removed
MINI COMPUTER

MC - Very few

When compared to the NC machine is CNC machine; the complete TRS and many of the manual controls are replaced by using mini computer and very few manual controls are present. In place of stepper motor as a drive unit, the servo motor is used as a drive unit.

Advantages

1. Bcz of usage of the servo motors higher positional accuracy are possible.
2. Due to the usage of mini computers; the programs can be fed into the computer through keyboard and memorise in the form of a software program. ... feeding of the program is easier, life of the software program is infinite, design modifications can be incorporated easily in the existing programs and by using graphic simulation software, cutter path can be generated and correctness of the program can be checked without physical manufacturing of the components.
3. Bcz of very few manual controls, the CNC machine can be completely automated of mechanised so that the less man less manufacturing can be done.

DNC [Direct Numerical Control System]

DNC is the system consisting of more than one CNC machine connected to the host computer through telecommunication lines or also called LAN.

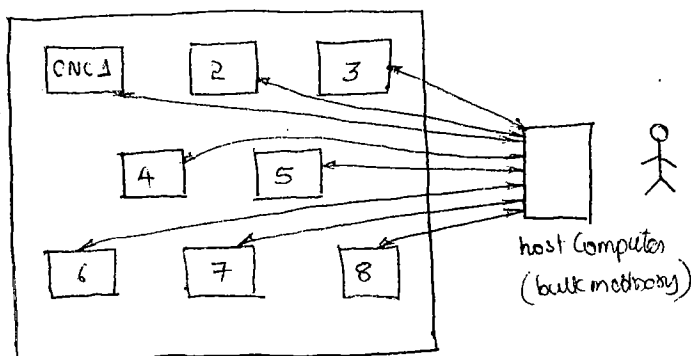

Whatever the programs required for manufacturing of different varieties of components in the industry can be kept in the memory of host computer. The programs required for manufacturing a given component on the machine can be downloaded from the host computer to the machines and give a command asking to execute the downloaded program at required no. of times to produce the components. Now all the machines are started working and producing the components. After some time one of the machines in the system will complete its job and comes to rest. Now this machine will send the information to the host computer asking what to do next. The person sitting in front of the host computer has been already decided; what is the next component to be done. ∴ he deletes the existing program first on the machine, download the next program and gives a command asking to execute the downloaded program at the required no. of times. This will take atleast 40-45 minutes because of the very low speed of the computer. During this time if one or more of the other machines also completes the job, they also will try to interact with host computer; but the host computer is busy with the 1st machine. Like this, when more than one machine is trying to interact with the host computer, the host computer is going into the hanging mode. This is called as traffic jam in DNC. To avoid this only a few number of machines are connected to the host computer.

- 186 - 1st generation computer
- 286 -
- 386 -
- 486 -
- pentium - only to 1995

As the programs required for manufacturing of different components are to be downloaded directly from the host computer every time; it is called direct numerical control system.

As the technology is growing; the cost of manufacturing of memory capacity of mini computer has been reduced. ∴ the memory capacity of mini computer has been increased from 5 MB to 100 MB. Now whatever programs required for manufacturing of different varieties of components can be downloaded and kept in the mini computer and so on. Whenever the machine comes to the rest and sending the message to the host computer, the person sitting in front of the host computer simply gives a command asking to execute so and so numbered program at so much no. of time. This will take less than a minute. ∴ the traffic jam is completely eliminated and many of the machines can be connected to the host computer. As the program has been distributed to the mini computer of the machines itself; the name given for this system is Distributed Numerical Control System [DNC].

Direct Numerical Control System become obsolete today and thus DNC refers to Distributed Numerical Control System.

ANC - Adaptive Numerical Control System

During writing of a program to the component, the programmer will calculate the optimum process parameters required for manufacturing of the given component and indicated in the program. Instead of the programmer is calculating the input parameters like properties of work material, tool material, tool geometry etc and output requirements like criteria of machining, surface finish requirements and accuracy of the dimensions to be produced etc. so that the machine itself is automatically adapting the optimum process parameters required for machining called as adaptive numerical control system.

Implementation of ANC is very simple; just by writing the search program. But for searching this input conditions and output requirements; it needs a database which is to be generated through experimentation.

Machining center:-

It is one of the advanced manufacturing method. If a machine is capable of performing all varieties of operations like turning, milling, drilling, shaping etc is called the general purpose machine tool. If the CNC is implemented in the general purpose machine tool is called as machining centre.

For performing different varieties of operations, the tools required must be kept in the tool storage unit called as tool magazine. Tool magazine has a capacity to store upto a maximum of 32 varieties of tool. When ever the tool is required to be changed, for automatic changing of the tool; an automatic tool changing unit (ATC) will be used in the machining centre.

Because of different varieties of operations performed on the machining centre, to hold the work piece for performing different varieties of operations, the elaborate fixtures are required.

Transfer machines and Transfer lines :-

Normally, a device used for removing the material or processing of the material is called as machine or machine tool. In addition to the processing of material, if the machine is also capable of handling of the material called as transfer machine.

If a robot arm is attached to the CNC machine for loading and unloading of the components is called as transfer machine.

If machines are arranged in the sequential order of operation to be produce performed, it is called product lay out or line layout.

Complete automation of product or line layout by using the transfer machines such that the manual manufacturing can be done. is called as a transfer line.

The machine used in the transfer lines are called as transfer machines.

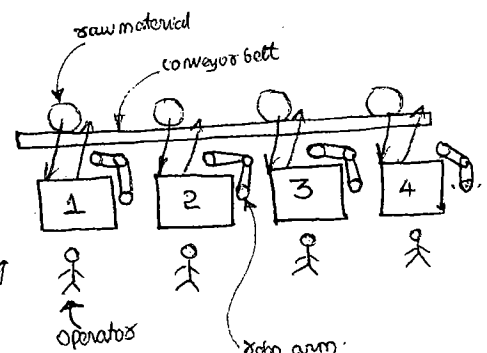

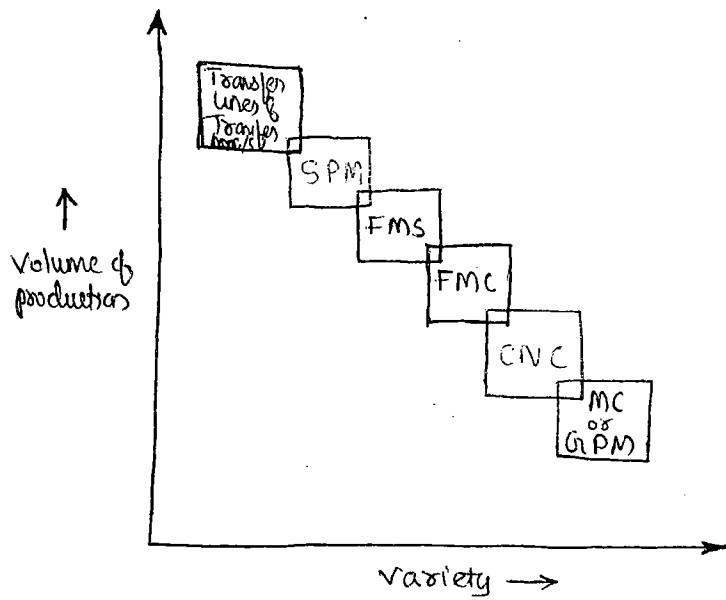

- SPM - Special purpose machine
- FMS - Flexible manufacturing sys
- FMC - flexible manufacturing Ce
- CNC -
- MC - machine center
- GPM - General Purpose mach.

From the above,

Like FMS and FMC's are used for producing medium varieties of components with medium volume of production. i.e. it is used for batch production applications.

FMS

Manufacturing system with flexible and random movement of the material among the different machines is called as flexible manufacturing system.

For obtaining the flexible movement of the materials among the different machines, the automated guided vehicle (AGV) is required.

$$\therefore \text{DNC} + \text{AGV} = \text{FMS}$$

FMC

Also called as cellular manufacturing.

Grouping different parts manufactured in the industry into a few number of group called as part families based on certain similarity is called as Group technology. The similarity used may be the manufacturing similarity, design similarity, shape similarity, size similarity, cost similarity and so on.

Whatever the machines required for manufacture of one part kept in shop floor A. machines required for manufacture of B is kept in shop floor B and so on is called as GT layout.

In GT layout once the raw materials enter into one shop floor, it always comes out as finished good. No transportation of materials is required from one shop floor to another shop floor.

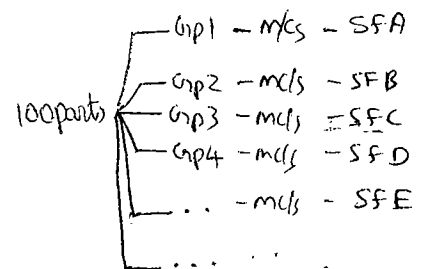

If FMS is implemented in each and every shop floor independently is called as flexible manufacturing cell or cellular manufacturing.

COMPUTER AIDED DESIGN [CAD]

The basic difference b/w the conventional design and computer aided design is in the case of conventional design the total body can be used as a single element in the analysis whereas in the computer aided design, the body can be divided into many no. of finite elements and the analysis will be continued on the elements. Bcz of the elemental analysis will be done by the cad, the analysis and design will be easier and more accurate. Bcz of elemental analysis, most of the uncertainties present during the usage of the component will be considered during the design itself. \therefore maximum factor of safety used in the CAD is 1.25. But in the conventional design the minimum factor of safety is 2. Also bcz of elemental analysis at the change in cross section as small size element as possible will be taken. \therefore no need to take the stress concentration factor for accounting to the change in cross section. whereas in conventional design, the stress concentration factor should be considered to account for the change in cross section.

Inputs required in CAD

1. Approximate shape
2. Loading condition
3. Material properties and allowable deflections

Process steps in CAD

1. Generation of 2-D drawings.
2. Input into the analysis package.
3. Convert into solid model.
4. Divide into many number of finite elements.
5. Apply the boundary conditions or loading conditions.
6. Maximum stresses and strains can be obtained.
7. Compare maximum stresses and strains with allowable stresses and strains.
8. Change the dimension of the components, repeat the procedure until maximum stresses induced in component is less than and nearly equal to allowable stresses. If satisfied, the dimensions of a component can be considered as the final design.

Output of CAD

1. 2-D Production drawing
2. Bill of Materials (BOM)
3. Stresses and strains induced.

COMPUTER AIDED MANUFACTURING [CAM]

Manufacturing with the use of computers is called as computer aided manufacturing.

$$\text{DNC} + \text{AGU} = \text{FMS}$$

$$\text{FMS} + \text{ASRS} + \text{CMM} = \text{CAM}$$

ASRS stands for Automated Storage and retrieval System.

It is an automation method used in the stores for retrieving the raw materials required for manufacturing and storing the finished goods.

CMM refers to Co-ordinate Measuring Machine. It is a measuring instrument (automated), used for measuring more than one dimension simultaneously.

Inputs

1. 2-D product drawing
2. BOM
3. Raw materials

Process steps

1. Generate CNC part program
2. Retrieving raw materials
3. Manufacturing of the components
4. Inspection by CMM

Output

1. Acceptable parts

CAD - CAM

It is an integral approach used for design and manufacturing of the components together without the use of manual intervention.

Inputs

Inputs of CAD

Process steps

Process step of CAD + CAM

Output

Output of CAM

COMPUTER Integrated Manufacturing [CIM]

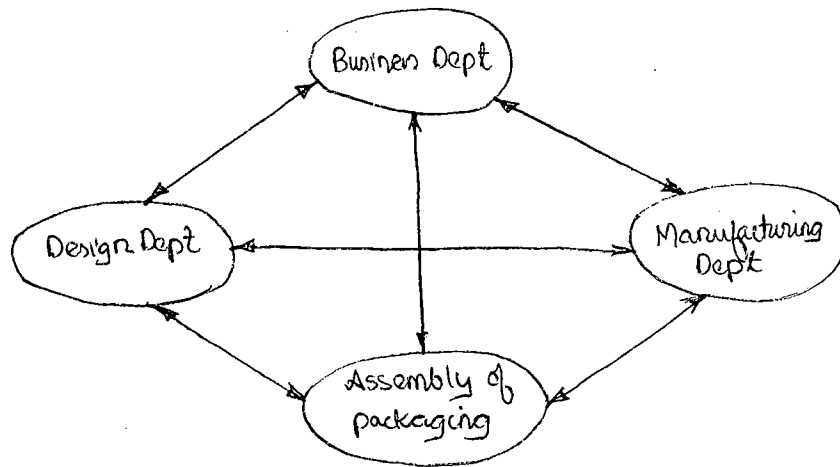

only firm which have implemented the complete CIM is DEL

If the different departments present in the manufacturing industry is integrated & using a computer such that modern manufacturing can be done, called as computer integrated manufacturing.

Part Programming of CNC machines

Part programming is a coded programming methodology used in the CNC machine & code used in the CNC programming indicates the name of the program given for specific movement of the tool.

G- Codes

General Purpose Codes

G00 to G999

G00 - Rapid traverse - whenever the tool is moving ideally; it is required to travel at maximum possible velocity. So as when the programmer indicates G00 in the program the machine will automatically adopt the maximum possible velocity to travel the axis. So that the time taken will be minimum and axis drive are safe.

G01 - Linear Interpolation - whenever the tool is required to travel linear for producing straight line shapes of the component the G01 code will be used.

* G02 - Circular Interpolation [C.W] - whenever the tool is required to travel in a circular path; the G02 or G03 code will be used.

* G03 - Circular Interpolation [C.CW] - whenever the tool is required to travel in the counter direction G02 code is used and for counter clockwise direction G03 code will be used.

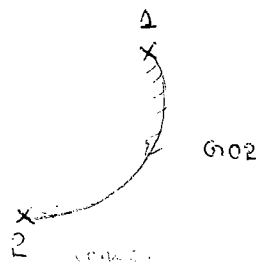
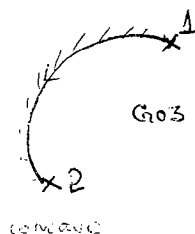

tool moves from point $P_1(5,5)$ to point $P_2(10,10)$ with G02 code. What is the co-ordinate of the centre of arc.

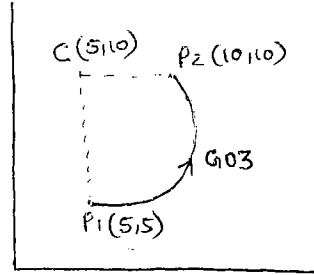
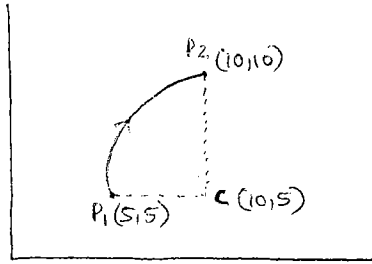

G04 - Dwell - temporary stoppage of the tool for specified duration
 F followed by number indicates the temporary stoppage duration in seconds.
 G04 F7 - temp stoppage for 7 seconds.

G05 - Hold - temporary stoppage of the machine for unlimited duration.

G08 - Acceleration - When G08 code is given; even though the speed has been indicated at high velocity, the machine always start with low velocity first and then reaches to the required velocity.

G09 - Retardation - When the tool is moving at very high velocity; it is difficult to stop the tool exactly. \therefore if G09 code is given, whenever the tool is nearing to the destination; the speed of the tool is automatically reduced so that it is possible to stop the tool wherever it is required.

G17 - XY plane
 G18 - YZ plane
 G19 - XZ plane } - plane selection

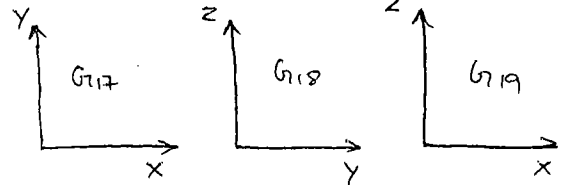

G33 - thread cutting with constant pitch
 G34 - increasing
 G35 - decreasing

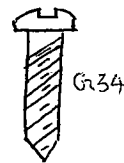

G41 - tool radius compensation left
 G42 - right

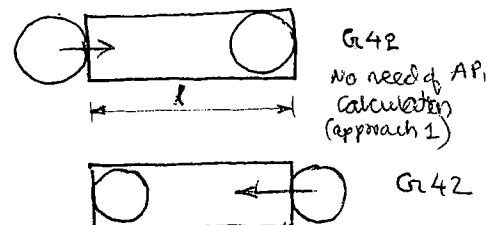

G70 - English programming - programming in terms of inches

G71 - Metric programming - mm programming

In latest system G71 is a default programming. (No need to specify code). If we want to do in inches then use code G70.

G90 - Absolute programming.

G91 - Incremental programming.

If movement of the tool to the program is always indicated w. reference to one reference point called as absolute programming

If the present position of the tool taken as a reference point for programming of the next position of the tool is called as incremental program

In general incremental mode of program is easy to write and easy to modify. But as per the Indian conditions, we prefer to use the absolute mode of programming.

During running of the program and producing the component, if power failure occurs, it is very difficult to identify, where the program has got stopped; if the program is written in the incremental mode. If the program is written in the absolute mode it is easy to identify where the location where the program has got stopped. ∴ after restoring the power, it is possible to continue the program from where it has got stopped

M- Codes [M00 - M99]

M00 - Program stop \approx G05

M01 - Planned stop \approx G04

M02 - End of main program without usage of sub program.

M17 - End of sub program

M30 - End of main program written with use of sub program.

During manufacturing process there is a repeatable movement is required, for this a program will be written called as sub program. This will be called in the main program whenever the repeatable movement of the tool is required.

subprogram

L100.SPF

SPF - subprogram function [it specify the file loc

L100 - name of sub program.

Always alphabetically to be placed.

Maximum length of subprogram name is 64 d with only numbers only alphabets or

Name of subprogram must always start with 'L'

Subprograms

L100 SPF
 N01 LF
 N05 LF
 N10 LF
 .
 .
 N110 M17 LF

N indicates the block number.
 In general the block numbers are taken as incremental no's only but not continuous no's bcz any modification in the design of component can be incorporated in the existing program without changing the next block no's of the program.

Main program

200 MPF
 N01 LF
 N05 LF
 N10 LF
 .
 .
 N16 M02 LF

Here also maximum 64 characters can be used for the name (either number, character or combination of both) But don't start with 'L'.

MPF and SPF is actually not given but automatically generated by the machine.

eg:- 200.MPF, 2AB10.MPF, AB20BC.MPF

100 MPF
 N01 LF
 N05 LF
 N10 L100 P5 LF
 N15 LF
 N20 LF
 .
 .
 N120 M230 LF

P followed by the number indicates the number of times the subprogram is to be executed at this location.

~~M10~~ N10 L100 LF = N10 L100 P1 LF

M03 - Spindle start in CW
 M04 - Spindle start in CCW
 M05 - Spindle stop.

M03 S500 LF
 M04 S800 LF

S followed by number indicates the spindle speed in rpm.

M06 - Tool change

M06 T10 LF

M07 - Coolant pump NO:1 ON
 M08 - NO:2 ON
 M09 - Coolant pump OFF

T followed by number indicates the tool number. It indicates that the present tool is to be changed with Tool no 10 by the ATC (automatic tool changing device)

M10 - Clamp

M11 - Declamp

G code and M codes are the major codes used. Other codes used are

Other than M01 and G04; where ever F followed by number indicates; the feed of the tool in mm/minute.

In all other case it represents

M01 F70 }
G04 ~~F60~~ }

N15 X60 Y90 F5000 L5

JIGS & Fixtures

Jig is a device used for holding and positioning of the work piece, locating and guiding of the tool. Generally Jig is light in construction and used in drilling, reaming tapping etc.

Fixture is a device used for holding and positioning of the w.p, locating and positioning of the tool but does not guide the tool. Generally, fixture is heavy in construction and used in turning, milling, shaping, grinding etc.

In general the jigs and fixtures are considered as accessories in the manufacturing industry. The advantages of using jigs and fixtures in the manufacturing industry are

1. The time taken for loading and setting of w.p is minimum.
2. Even unskilled person also can be able to load and set the w.p in m/c.
3. Bcz of use of jigs and fixtures, consistency in manufacture is very high.
4. Accuracy of the component produced would also be very high.
5. Production rate will increase.
6. Due to consistency in manufacturing, 100% inspection is not required. ∴ cost of inspection is reduced.
7. Reduction in lead time of manufacturing.
8. Safety in manufacturing is also very high.

The use of jigs and fixtures is economically justifiable only when sufficient quantity of components are manufactured.

Basic Parts

1 Body

It should be rigid enough to withstand the self weight of the w.p and the forces acting during machining. It also can able to absorb the vibrations generated during machining.

Body can be made by using grey cast iron with casting as a manufacturing method.

2. Locating elements

3. Clamping elements

4. Tool guiding elements in space jigs. - Bushes

5. Tool setting elements in fixture - Reference point marked on fixture

2. Locating elements :-

A body in space has 12 degrees of freedom

- +x, -x - 2
- +y, -y - 2
- +z, -z - 2
- CW, CCW, along x - 2
- 2
- 2

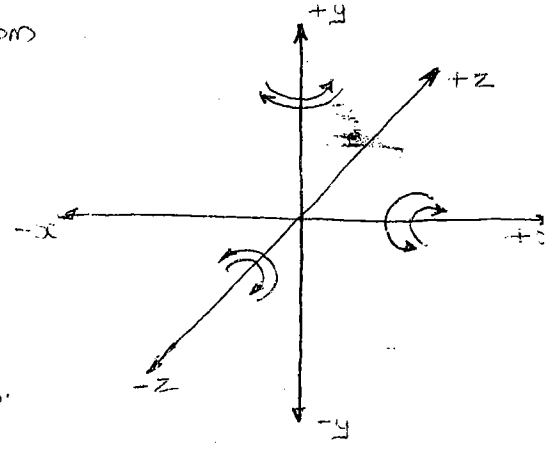

6 linear and 6 angular degrees of freedom.

In general by using locating elements, it is always allowed to arrest maximum of 9 degrees of freedom only. so that the 3 degrees of freedom will be left over - out of the 3 dof, 2 dof will be used for loading and unloading of the component, 1 dof will be used for movement of the tool.

During actual machining operation, the 2 dof used for loading and unloading will be arrested by using clamping elements and 12th dof is arrested by using cutting forces acting by the tool.

principles used in location

During designing of locating elements there are 3 principles which needs to be satisfied by the locating elements.

1. Principle of perpendicular planes :-

whatever the locating elements used for locating the w.p, must be provided only in the perpendicular planes.

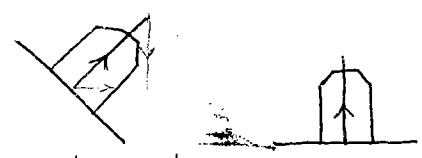

resolved components remains unbalanced so extra clamp is to be provided.

2. Principle of minimum location

whatever the locating elements used for locating the w.p in the given plane must be as minimum as possible to arrest maximum number of degrees of freedom.

3 Principle of extreme positions

If only one pin is used for locating, in a given plane — provide in the centre. But

when more than one pins is provided. It is always recommended to provide at the extreme position only.

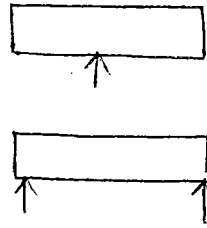

methods of location :-

1. 3-2-1 method of location

This method is used for locating cartesian coordinate system of a component.

3, 2, 1 represents the no. of pins used in the ~~two~~ 3 mutually \perp planes for arresting required No. of degree of freedom.

3 pins - 5 DOF [1L + 4R] is arrested



(max. No. of DOF arrested in a single plane is 5. What ever the No. of pins we use we could only arrest 5 DOF, so we use 3)

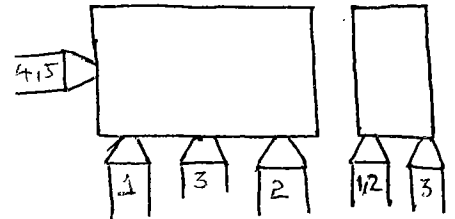

2 pins - 3 DOF [1L + 2R] is arrested

(if we arrest 5 DOF here total (4+4) = 8R but only 6R i.e. we arrest 2R which is already arrested. To avoid this redundancy we only arrest 3)

4 pins - 4 DOF

9 DOF Total is arrested

2. V-location

This method is used for locating cylindrical co-ordinate system of a component.

V-block is used.

V-block - 7 DOF [3L, 4R] is arrested

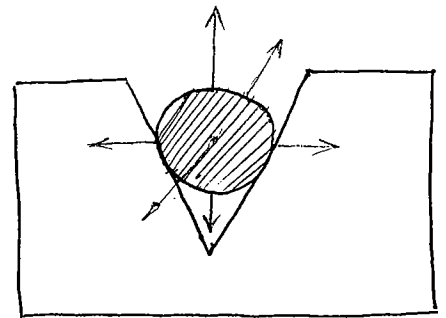

3. Bush location cum clamping

This method is used for locating spherical co-ordinate system of a component.

All 12 DOF is arrested
 so that whenever the component
 is to be unloaded or next
 component is to be loaded, the
 bush clamps can be removed

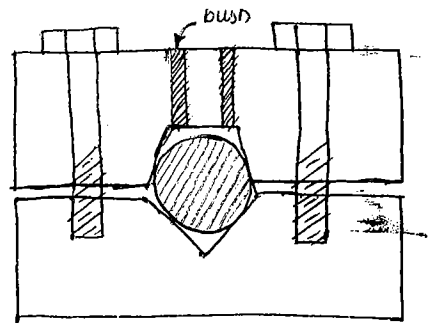

4. Pin/Radial/Diamond location

This method of location is used for
 locating a plate like component with very
 small thickness and having atleast 2 holes

In total 11 DOF is arrested

only 1 DOF is available for the movement
 of tool as well as loading and unloading
 of the w.p.

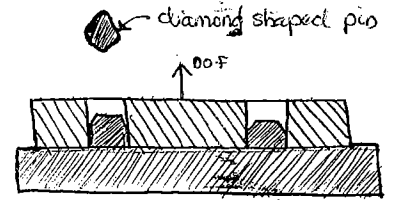

only 4 points
 contact will be there
 so easy to remove and
 also it won't allow
 the lateral movement.
 the hole size is larger in
 case of circular pin.

3 Clamping elements

a. C-clamp

used for clamping cartesian co-ordinate
 since the body looks like C - it is called
 as C-clamp

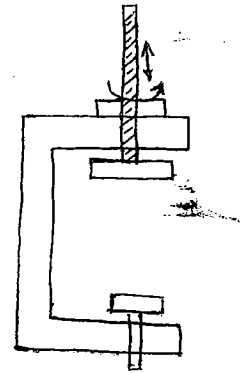

b. Rectangular clamp or V clamp

for clamping cylindrical coordinate
 system of a component

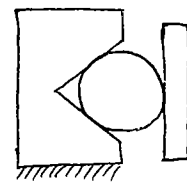

Rectangular clamp

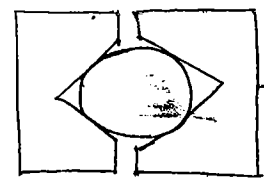

V-clamp

c. Bush location cum clamping

Common principles used in design of Jigs and fixtures.

1. The design of jig or fixture must be such that the time taken for loading and unloading must be as minimum as possible.
2. The design of jig or fixture must be such that the loading and unloading of the component must be as easy as possible and even unskilled persons should be able to load and set the component.
3. The design of jig or fixture must be such that it should be as open as possible for easy removal of the chips.
4. The design should be such that the variation in dimension of the component can be accommodated easily.
5. It should be rigid enough to withstand the forces and weight of the w.p.
6. The design should be fool proof. The design is such that during loading of the component, the jig or a fixture should allow the component only if it is loaded in the specified direction.
7. For easy handling of the fixtures, it is required to provide the eye bolts, trunnions etc on the CG location.
8. Soft inserts must be available for locating delicate components without damaging.
9. Ejectors must be available for easy unloading of the component from the jig or a fixture.

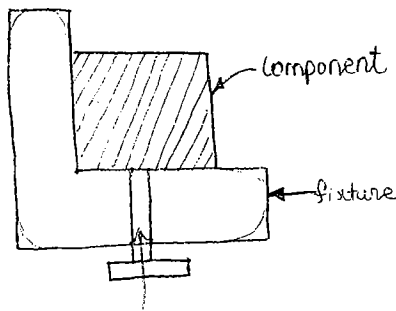

Here surface contact is there. During machining coolant is supplied and it may get adhered and stick both the component and fixture. Thus it would be difficult to remove. Thus ejectors should be provided.

10. Safety in the working conditions. No sharp edges and projections of bolt heads, nuts etc. should be allowed.
11. The machine operator should be able to see the machining zone; just by standing away from the jig or fixture without bending his body or head.
12. Design must be simple and cheaper.

Q.1

1 rev of L.S = 5mm

1mm → 1/5 rev

200mm → 1/5 x 200 = 40
= 40 x 360°

= 14400

(a)

Q.2

BLU = dist travelled per pulse

No of pulse = 9 / BLU = 9 / 0.05 = 18000/-

(b)

Q.3

1° per pulse

1 rev → 360°

→ 360 pulses/rev

360 pulse → 1 rev of motor

= 1 rev of L.S

= 3.6mm

1 pulse = 3.6 / 360 = 0.01mm

= 10 microns

(b)

Q.4

(c)

Q.5

(d)

Q.6

10V → 100 rpm

→ 100 x 5 = 500 mm/min

3000 mm/min → 10 / 500 x 3000 = 60 Volt

Q.7

(b)

Q.8

(e)

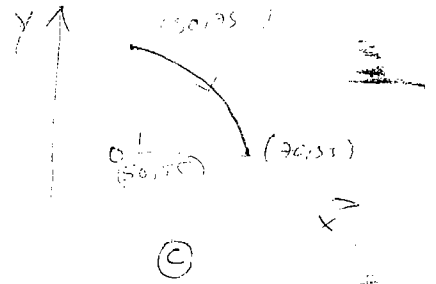

Q.10

(B)

Q.11

(A)

Q.12

(B)

Q.13

(B)

Q.14

A

Q.15

(15,15) C

Q.16

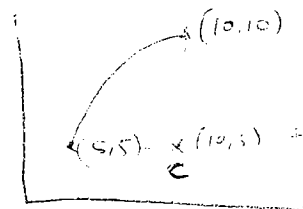

In an event of error correction, 1
error input should not be more
than 1000 and the error correction

1000 X 5 Y 5

1000 X 10 Y 10

Q.17

1 pulse = 1.8"

360 / 1.8 = 200 pulse

200 pulse = 1 rev
= 2 min

1 pulse = 3 / 200 = 0.015"

0.015"

Q.18

200 pulse \rightarrow 1 rev
 $\rightarrow \frac{4}{4}$

gear ratio \downarrow
~~4~~ (4)

200 pulse \rightarrow 1 rev of motor
 $\rightarrow \frac{1}{4}$ rev of LS
 $\rightarrow \frac{4}{4}$ rev

1 Rev $\rightarrow \frac{1}{200} \text{ m} = \underline{\underline{5 \text{ micro}}}$

Q.19 (C)

Q.20 $\frac{4}{150} \times 200 \times 60 =$

~~Q.21~~

Q.22 batch production, large

Q.23 (d)

Q.24 (a)

Q.25 C

Q.26 (A)

~~Q.27~~

Q.28 (A)

Q.29 (A)

Q.30 (B)

~~Q.31~~
~~Q.32~~

Q.33 A

Q.34 C

Q.35 C

Q.36 C

Q.37

A \checkmark
R \checkmark (A)

Q.38

A \checkmark
R \checkmark (A)

Q.39

A X - closed loop
R \checkmark

am false reason too

Q.40

B

Q.41

A - 4 4, 5, 1, 3
B - 5
C - 1
D - 3

Q.42

batch production

Q.43

fake

Q.44

FAPT - is a prog lang
part prog by no keys

Q.45

(A)

Q.46

DNC

Q.47

(B) - servo motor sh be
we but
sin drum point to pol
steppe 6 210

Q.48

(A) assistance

(B) hazard.
 \rightarrow spray pen

Q.49

(A)

Q.50

(A)

Q.51

(C)

~~Q.52~~

Q.53 (A)

Q.54 C

Q.55 (D)
Q.56 C
Q.57 A
Q.58 D

29/11/11

NON TRADITIONAL MACHINING

non conventional machining

Limitations of the traditional machining method

The tool must be atleast 30-50% harder than the work material but sometime work itself will be very hard and there will be no tool available which is harder than the work piece.

Some materials will have very poor machinability. Such materials cannot be machined with conventional methods.

Small size non-circular holes cannot be produced by using conventional methods. but large size non-circular holes can be produced by broaching process.

Making small size circular hole is also not possible.

Making holes in the highly brittle materials is not possible.

Machining of very soft materials like rubber is not possible.

Manufacturing of complex concave curvature is not possible

Non-Traditional Machining

- 1 USM
- 2 EDM
- 3 ECM
- 4 WJM
- 5 AWJM
- 6 EBM
- 7 LBM

For all the above methods ; we deal with

(a) mechanism of chip formation

(b) tool material

(c) medium

(d) wear ratio/machining ratio

$$WR = \frac{\text{Volume of Material Removal on W.P}}{\text{Volume of tool wear}}$$

(e) advantages

(f) disadvantages

(g) applications

(1) Ultrasonic Machining Methods

When the tool is vibrating at high frequency, the impact load produced by the tool will be acting on to the abrasive particle, which in turn produces the impact loads on to the work piece. When the impact loads are acting on the work piece, if the w.p material is a highly brittle material,

bcz of lower toughness the w.p is getting fractured due to brittle fracture. The chips produced due to this will be moving along with the abrasive slurry. From the above, the mechanism by which the chip formation takes place is brittle fracturing.

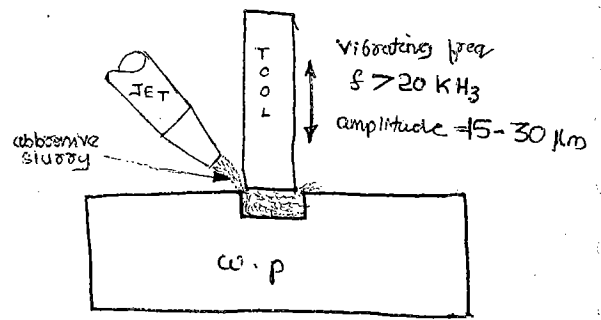

When the impact load is acting on to the abrasive particle, the equal and opposite reaction force produced by the abrasives will be acting on to the tool. ∴ if the tool is made by using hard material, the brittle fracturing will take place on the tool also. Hence wear of the tool will be higher. To minimize the wear of the tool, the tool must be made by using very soft or very soft materials. The most commonly used tool material is Cu, brass, mild steel etc.

The medium used is abrasive slurry. i.e. abrasive + slurry. The most commonly used abrasive particle is Al_2O_3 , Silicon Carbide, Boron Carbide, diamond etc. As the size of abrasive particle is increasing, the material removal rate, increases first and then reduces. The most commonly used size of the abrasive particle is 200-600 μm . Boron Carbide abrasive will be used with water as a slurry and other abrasives will be used with paraffin as a slurry. The composition of abrasive-slurry is 50-60% by volume is abrasive.

Wear ratio varies from 1.5 to 100. The wear ratio mainly depends on the brittleness of the work piece material. i.e. higher the brittleness higher will be the wear ratio.

Tool	WP	WR
Cu	Brass	100
Cu	Ceramic	75
Cu	Flintstone	15
Cu	Quartz	50
Cu	H.C steel	1.1

Advantages

- Highly brittle materials can be machined very easily.
- Smaller size non-circular holes can be produced.
- Electrical conductivity of w.p is not required.
- It's not a hazardous process.

disadvantages

$\frac{L}{D}$ ratio upto 3 only will be possible [deeper holes cannot be produced]

Bcz of brittle fracturing mechanism - poor surface finish - poor dimensional accuracy

specific cutting energy requirements are higher.

Applications

Used for producing circular and non-circular holes in highly brittle materials like glass, ceramic, tungsten carbide etc.

The dentist uses USM for producing holes in the human teeth; since it a painless drilling method.

Holes of size upto 0.1mm can be produced by using E USM.

2 Electric Discharge Machining Operation

When the power supply is given to the RLC circuit, nearly 75-80% of cycle time duration, the energy supplied by the power supply unit will be stored in the RLC circuit bcz the RLC circuit in electric technology is working like a flywheel in mechanical system. During remaining 20-25% of cycle time duration, the energy stored in the RLC circuit and energy supplied by the power supply unit will be released

spontaneously so that where ever gaps are provided in the circuit, such place spark are produced. (ie b/w the tip of tool and w.p). Bcz of sparking; the heat is generated at tool the interface of tool and w.p. By using this heat the w.p material is melting and evaporating. To increase the evaporation efficiency of the metals; the sparking zone will be immerse in a dielectric fluid. Bcz the evaporation is taking place inside the liquid and vapours are continuously coming out, at the sparking zone, the pressure falls to below the partial pressure of water vapour in the atmosphere. Hence cavitation is occurring. This cavitation promotes the material removal. Thus the mechanism of chip format is melting and evaporation associated with cavitation or spark erosion and cavitation.

To avoid the heat generation with in the tool; the tool material must be made by using high electrical conductivity material and to minimize the melting of tool; the high MP material is to be used. The most commonly used tool materials are Cu, W or copper-tungsten alloy, graph

The medium used is dielectric fluid. The most commonly used is

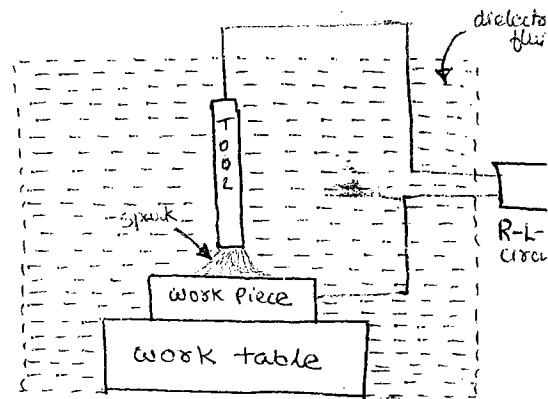

$WR = 0.1$ to 10 . The wear ratio is mainly depends on the difference b/w MP of the tool and w.p material.

MP of tool \gg than MP of w.p $\rightarrow WR \uparrow$

eg:- During machining of Al using Tungsten Carbide as tool $WR = 10$.
During machining of Steel w.p using Cu as a tool $WR = 0.1$
(10x MP)

Advantages

$\frac{L}{D}$ ratios as high as 20 is possible

There is no physical contact b/w the tool and w.p - No forces are acting in machining. Hence no residual stresses are developed in the w.p.

Out of all the unconventional machining methods EDM is the one which gives the highest MRR and EBM will give the lowest MRR (Material Removal Rate)

By melting and evaporation is the mechanism of chip formation, the mechanical properties of w.p materials will not affect the material removal rate.

Surface finish produced will be better.

Disadvantages

Work piece material must be electrically conductive.

Perfect square corner/hole cannot be produced.

Hardening of the work piece will take place & near to the hole hardness of w.p will be high.

Applications

It's used for producing very small sized holes like holes in the diesel injection nozzle.

Used for producing holes in the air brakes.

Used for die sinking.

Wire cut EDM - is similar to EDM but used for cutting sheets into complex shapes. In this process a continuously moving wire will be used as a tool so that the sparks are produced b/w circumference of the wire and w.p. As the machining is progressing, in case of EDM length of the tool will be reducing. But in case of wire cut EDM, dia of the wire is reducing.

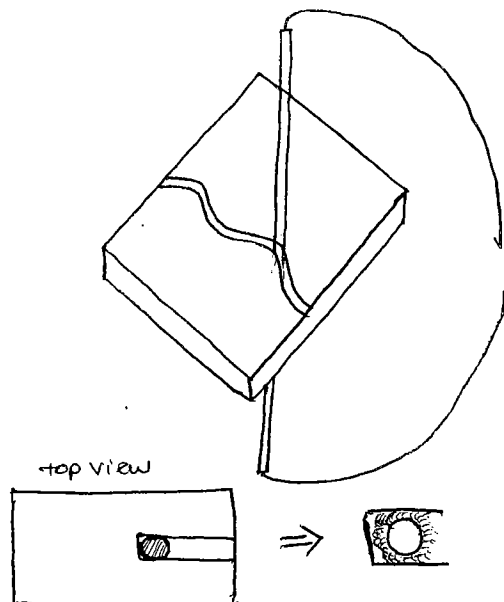

3. Electrochemical Machining

When the power supply is given to the w.p and the tool, bcz of Faraday's laws of electricity; the ions are displacing from the workpiece and trying to deposit over the tool. Before they are depositing, when the electrolyte present b/w the tool and w.p will be pumped out continuously so that the tool ions displaced from the w.p are also moving along with the electrolyte. Hence there is no disturbance taking place to the tool. The same tool can be used for producing infinite number of components. From this the mechanism by which the chip formation taking place is due to ion displacement. The no. of ions displaced or MRR in ECM

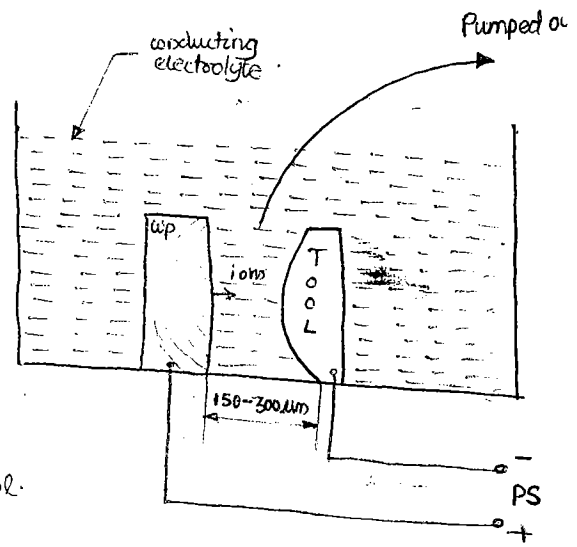

- (a) directly proportional to the gram atomic wt of the w.p material.
- (b) directly proportional to the current density of the ECM process.
- (c) Inversely proportional to the distance b/w the tool and w.p.
- (d) Directly proportional to the electrical conductivity of the electrolyte is
 - for rough machining operation - high electrical conducting electrolyte is used also called as pamivating electrolyte.
 - for finish machining operation - low electrical conductivity electrolyte is used also called as nonpamivating electrolyte.
- (e) In addition to the above, the electrolyte must be chemically stable, low visc and having high specific heat.

If the tool and w.p are made by using same material and w.p is connected to +ve terminal of the power supply, more no. of ions are displacing from the w.p. ∴ the tool must be made by using ~~same~~ same material as that of the w.p.

The medium used is conducting electrolyte; preferably salt solution.

Bcz the tool wear = 0 - WR = ∞

Advantages

Complex concave curved components can be easily produced by using complex ~~convave~~ curved tool. (which can be produced by normal or CNC machining)

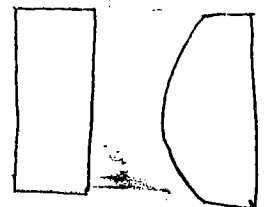

Since tool wear = 0. same tool can be used for producing infinite no. of components

Bcz there is no direct contact b/w tool and w.p, no forces and no residual stresses.

Bcz of ion displacement mechanism; the surface finish produced is excellent

Disadvantage

Out of all the unconventional machining method, ECM require highest specific cutting energy.

W.P must be electrically conductive

Generally preferable for producing contours only.

Sharp corners is not possible to produce.

Applications

Used for producing complex shape of components like turbine blades.

For ECM

$$MRR = \frac{AI}{ZF}$$

A - Atomic wt of w.p

I - Current passing thru the w.p

Z - Valency of the w.p material.

F - Faradays constant
= 96500

Electrochemical Grinding (ECG) is a variation of ECM.

In ECG, the rotating grinding wheel will be used as a tool; material so that the material removal is taking place due to electrochemical process and mechanical process as 90:10%.

The gap b/w the tool and w.p is mainly controlled by using the size of the abrasive particle present in the grinding wheel.

It's developed for grinding of very hard work pieces like grinding of carbide cutting tools.

Even though carbide cutting tools are regroundable by using ECG, but is not preferable bcz; the cost of ECG is much higher than the new cutting tool itself.

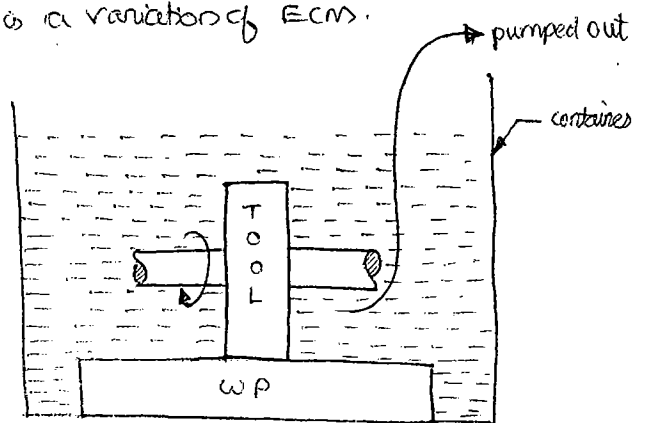

4 Water Jet Machining

When the very high pressure water is passing through the convergent nozzle, the pressure energy is converted into velocity energy. ∴ the water is coming out from the nozzle at very high velocity. When this high velocity water jet is impinging on to the WP, the continuous impact load will be produced on the WP so that the work piece material is plastically deforming and fracturing will be taking place. i.e. the mechanisms by which material removal is taking place by plastic deformation and fracturing or called as etching process.

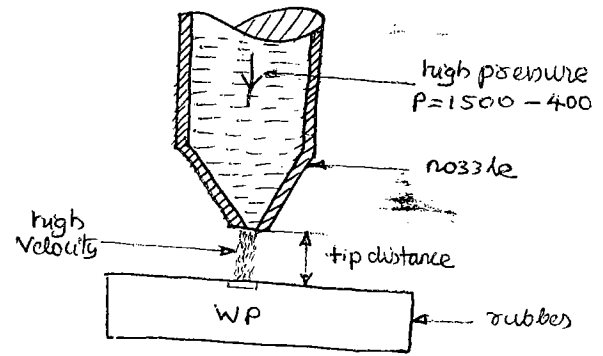

The nozzle would be considered as the tool.

As to withstand the high pressure of water, the nozzle or tool is made by using WC.

Medium is water.

$$WR = \infty$$

Advantages

Used for machining of very soft materials like rubber.

Limitations

Pressurising the water to very high pressure is difficult. It can't be used for machining of hard W.P.

- To overcome this disadvantage - abrasives are added to water so that the abrasive particle also will be coming out from the nozzle tip at very high velocity and when this high velocity abrasive are impinging on to the hard W.P.; it is possible to produce the local plastic deformation in the hard W.P. also. Hence the fracturing and chip formation is taking place. This is called as abrasive water jet machining.

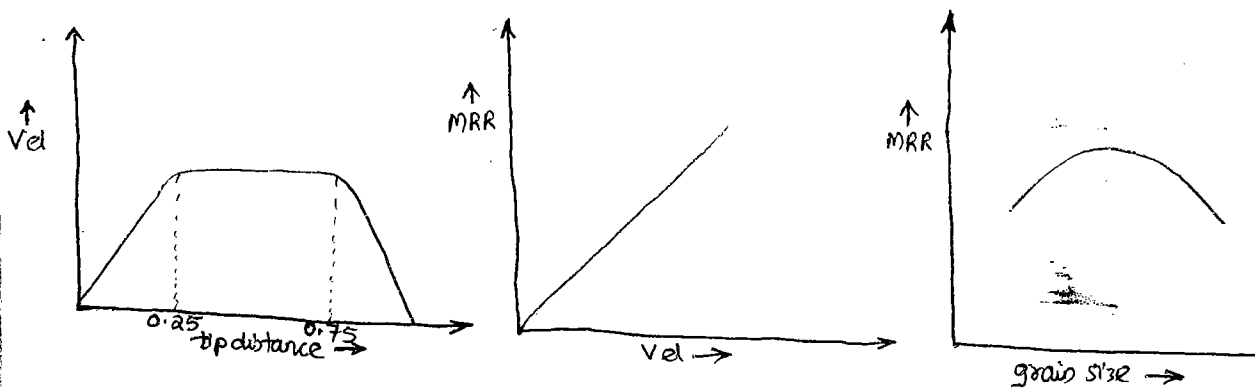

(6) Electron Beam Machining

When very high voltage power supply is given to the electron gun, it produces very high velocity electrons in all the directions. By providing a magnetic lens or deflector, all the high velocity electrons will be collected and form like a beam of electrons which is having the cross sectional area less than 0.05 mm^2 .

When this high velocity electron beam is impinging on to the W.P., the KE of electrons is converted into heat energy.

\therefore The heat is getting generated at the W.P. This heat will be used for melting and vapourisation of the W.P. material. From the

above the mechanism of material removal is by melting and vapourisation.

After the magnetic deflector; b/c of presence of air resistance; the electrons may get dispersed again. To avoid this the total setup will be kept in the container and perfect vacuum is maintained inside the container. B/c of the perfect vacuum, highly reactive metals can be machined very easily without any oxidation.

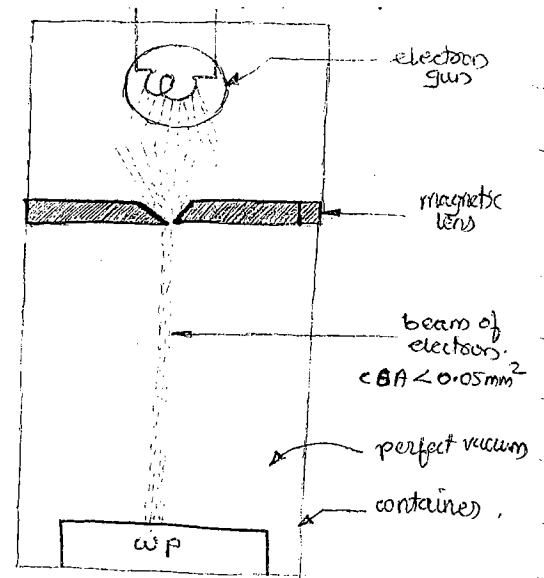

Electron gun is used as tool
medium is perfect vacuum

$$MRR = \infty$$

Advantages

Very very small size holes and narrow slots can be produced very easily.
Highly reactive metals like Al and Mg can be machined easily.

Disadvantages

Maintaining perfect vacuum is difficult.

Lowest MRR

B/c the total equipment is kept inside the container, the machining process cannot be seen by the operator.

Applications

Used for producing very small sized holes and narrow cavities in electrically conducting material.

If voltage of power supply to the electron gun is reduced to about 70-80,000 V the velocity of electrons is reducing, the heat generated at W.P. is reducing. \therefore the W.P. is only melting, but no evaporation takes place. This melting of the W.P. can be used for joining purpose. It is called as electron beam welding.

7 Laser Beam Machining

When the power supply is given to the laser gun, it produces high intensity electromagnetic waves having the wavelength 0.1 to 70 μm ;

Laser beam has a cross-sectional area of $< 0.05 \text{ mm}^2$.

When this laser beam is impinging on to the W.P., the electromagnetic wave energy is converted into heat energy at the surface of the W.P. \therefore the surface layer of the W.P. is melting and evaporating. But for further layers, the heat is transferring by conduction process. When the 1st layer is evaporating, the second layer of material is exposing for electromagnetic waves.

This also get melted and evaporated. Like this; the layer by layer of W.P. material is getting exposing for electromagnetic waves, melting and evaporating. Hence this process is looking like a ladder called as staircase process. From the above the mechanism of material removal is by melting and vapourisation.

Tool material is Ruby rod.

Medium is air

$$W \cdot R = \infty$$

Advantages :-

No vacuum is required; hence the process will be easier.

The size of holes produced is same as EBM.

Bcs ruby rod is flexible - to some extent zig zag holes can be produced by using LBM.



Disadvantage.

Major disadvantage of LBM is that huge amount of power is required (5000 to 6000 MW). Every country would be having only 1 such machine. (India not having). That too operated one is a blue moon.

24

ILDS and Fixtures

Q.1 (A)

Q.2

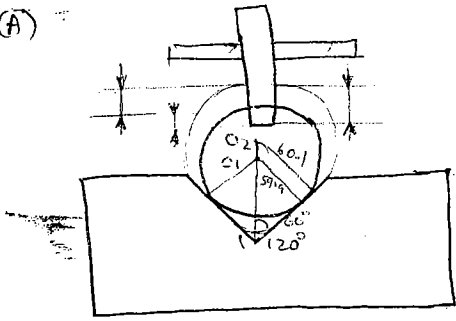

$$O_1A = \frac{59.9/2}{\sin 60}$$

$$O_2A = \frac{60.1}{2 \sin 60}$$

$$O_{102} = O_2A - O_1A$$

$$\text{errors in depth} = 2 \times O_{102} = 0.22 \text{ m} \quad (C)$$

Q.3 C

Q.4

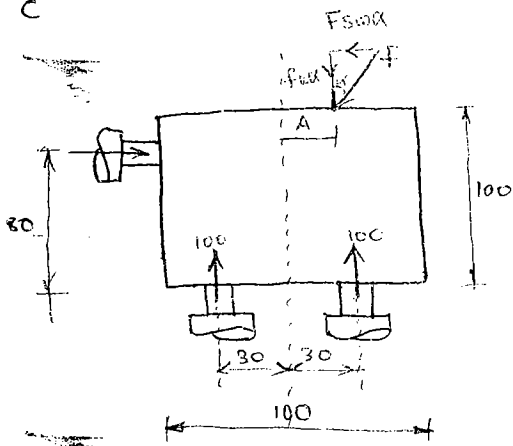

$$(a) \frac{F \sin \alpha}{F \cos \alpha} = \frac{100}{100+100} = \frac{100}{200}$$

$$\tan \alpha = \frac{100}{200}$$

$$\alpha = \tan^{-1} 1/2$$

$$F = \frac{100}{\sin \alpha} =$$

$$(b) (F \cos \alpha \cdot A) + (100 \times 30) = 100 \times 30 + (100 \times 20)$$

$$A = \frac{100 \times 20}{F \cos \alpha} = \frac{100 \times 20}{200}$$

$$A = 10 \text{ mm}^2$$

~~Q.5~~

Q.6

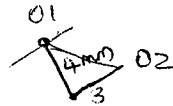
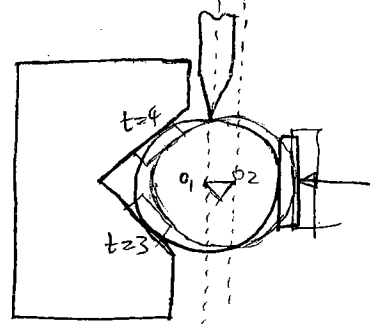

$$O_{102} = \sqrt{4^2 + 3^2} = 5$$

$$\sqrt{x^2 + x^2} = 5$$

$$2x^2 = 5^2$$

$$x = \sqrt{\frac{5^2}{2}}$$

(2) is preferable \Rightarrow stable method

Q.7

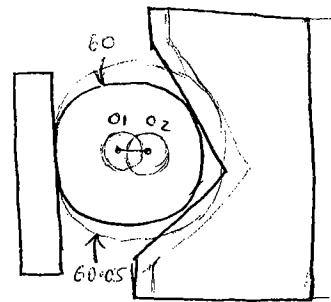

$$\text{errors in position of hole} = O_{102} = 30.025 - 30.00 = 0.025$$

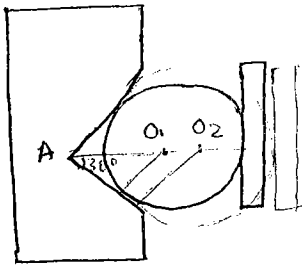

$$AO_1 = \frac{30}{\sin 60}$$

$$AO_2 = \frac{30 \cdot 0.25}{\sin 60}$$

$$0.029 = AO_2 \Rightarrow AO_1 = \underline{\underline{0.029}}$$

Positional error is depends on the fixed element alone.

(c) same as ~~two~~ (2)

position error = 0.029.

best one is 1st case

p.76

Q.8

(A) 3 component to Ge is fixed part

Q.9

(D)

2.1

A-5, B-3, C-2, D-4

Q.2 (B)

Q.3 (C) diamond is the hardest particle

Q.4 A-3 B-4 C-5 D-2

Q.5 A-4 B-1 C-3 D-2

Q.6 rigid

Q.7 (C)

Q.8 (A), (D)

Q.9 A - electrochemical
B - mechanical

Q.10 USM - Enlan is machined only with USM.

Q.11 (B)

Q.12 (b) 2-1-4-3

Q.13 (d) 2-3-1

Q.14 (d) 3-4-2-1

Q.15 A-5 B-2 C-6 D-1

Q.16 A ✓
B X - It's easy to process but it is environmentally non-biodegradable.

Q.17 A-4 B-3 C-1 D-2

Q.18 A-1 B-2 C-3 D-4

Q.19 A-1 B-2 C-4 D-3

Q.20 (d)

Q.21 (C)

Q.22 A-2 B-4 C-1 D-3 (C)

Q.23 5-1-4-2 (A)

Q.24 (C) erosion & count

Q.25 2-3-5-6 (d)

Q.26 (C)

Q.27

Q.28 (A)

Q.29

AV
RV

but reason is not correct.

(B)

Q.30 (B)

lowest for EDM
highest for EDM

Q.31

(C)

Q.32 (A) ?

Q.33 (C)

Q.34 (a)

Q.35 4-2-1-3 (C)

Q.36 (d)

Q.37 (d)

Q.38 (C) (d)

Q.39 (a) 4-3-1-2

Q.40 $MRR = \frac{AI}{Z}$ (a)

Q.41 (d)

Q.42 $\frac{AI}{ZF} = \frac{630 \times 5000}{1 \times 96500} = 3.26$

(B) 3

Q.43

$MRR = \frac{AI}{ZF}$

$A = 35.85$

$I = \frac{V}{R}$

$f = 296540$

$Z = 2$

$R = \frac{81}{A} = \frac{2000 \times 0.02 \text{ cm}}{2 \times 10 \times 0.2} = 0.3471$ (a)

Q.44

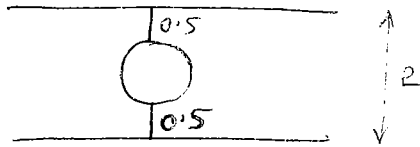

$$MR = 2 \times 5 \times 20 = 200 \text{ mm}^3/\text{m} \quad (b)$$

Q.45

(d)

Q.46

(c)

As $\phi \uparrow$ then $a \uparrow$

Q.47

(d)

Q.48

(d)

Page 10

Metal cutting

Q.1

$$\left. \begin{aligned} V_c &= 30 \\ V &= 15 \\ x &= 10 \end{aligned} \right\} \delta = \frac{V_f}{V_c} = 0.5$$

(a) $\phi = \tan^{-1} \left(\frac{\delta \tan \alpha}{1 + \delta \sin \alpha} \right)$

Q.2

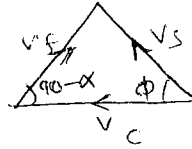

$$\frac{V_s}{\cos \alpha} = \frac{V_f}{\sin \phi}$$

$$V_s = \frac{V_f \times \tan \alpha}{\sin \phi} = (d)$$

Q.3

$$\begin{aligned} t_1 &= 2 \\ b &= 15 \\ V_c &= 0.5 \\ \alpha &= 0 \\ f_c &= 900 \\ f_r &= 600 \\ d &= 30 \end{aligned}$$

$$\tan(\beta - \alpha) = \frac{f_r}{f_c}$$

$$\beta = \alpha + \tan^{-1} \left(\frac{f_r}{f_c} \right)$$

$$\mu = \tan \beta$$

$$\text{Ans: } (c) \frac{2}{3}$$

Q.4

$$P = f_c \times V_c = 900 \times 0.5 = 450 \text{ W} \quad (b)$$

Q.5

$$L_s = \frac{z_1}{\sin \phi} = \frac{2}{\sin 30} = 4 \text{ mm} \quad (d)$$



Q.6

$$2\phi - \alpha = 90$$

$$\phi = \frac{90 + \alpha}{2}$$

$$= \frac{40 + 12}{2} = 26$$

Q.7

$$f_2 = \frac{f_1}{2}$$

$$d_2 = 2d_1$$

$$a = 0.3$$

$$b = 0.3$$

$$c = 0.15$$

$$V_1 T_1^a f_1^b d_1^c = V_2 T_2^a f_2^b d_2^c$$

$$\begin{aligned} V_2 &= V_1 \left(\frac{f_1}{f_2} \right)^b \left(\frac{d_1}{d_2} \right)^c \\ &= V_1 (2)^{0.3} (1/2)^{0.15} \\ &= 1.11 V_1 \end{aligned}$$

$$\% \text{ change} = \frac{V_2 - V_1}{V_1} = \underline{\underline{11\%}} \quad (b)$$

Q.8

productivity \propto MRR

$$\begin{aligned} \% \text{ change in productivity} &= \frac{MRR_2 - MRR_1}{MRR_1} \\ &= \frac{V_2 f_2 d_2 - V_1 f_1 d_1}{V_1 f_1 d_1} \\ &= \underline{\underline{110\%}} \end{aligned}$$

(b)

Q.9

$$\alpha = 6^\circ$$

$$a = 0.5$$

$$b = 3$$

$$\left. \begin{aligned} t_1 &= 1 \\ t_2 &= 1.5 \end{aligned} \right\} \gamma = \frac{t_1}{t_2} = \frac{1}{1.5} =$$

$$2\phi + \beta - \alpha = 90^\circ$$

$$\phi = \tan^{-1} \left(\frac{\gamma \cos \alpha}{1 - \gamma \sin \alpha} \right)$$

$$2\phi + \beta - \alpha = 90$$

$$\beta = 90 + \alpha - 2\phi$$

$$\mu = \tan \beta$$

$$0.467 \quad (c)$$

Q.10

$$\gamma = \frac{V_2}{V_1} \Rightarrow V_2 = \gamma V_1$$

$$= \frac{1}{1.5} \times 0.5 \times 60$$

$$= \underline{\underline{20 \text{ mm/min}}}$$

(b)

Q.11

Area of shearing plane

$$A_s = L_s \times b$$

$$= \frac{L_1}{\sin \phi} \times b = \frac{1}{\sin \phi} \times 3$$

$$= 5.2 \text{ mm}^2 \quad (c)$$

Q.12

 $V_0, T_0 \rightarrow$ original value

$$V_1 = 1.2 V_0$$

$$T_1 = 0.5 T_0$$

$$V_0 T_0^n = V_1 T_1^n$$

$$\left(\frac{T_0}{T_1} \right)^n = \left(\frac{V_1}{V_0} \right)$$

$$n \ln \left(\frac{T_0}{T_1} \right) = \ln \left(\frac{V_1}{V_0} \right)$$

$$n = \frac{\ln \left(\frac{V_1}{V_0} \right)}{\ln \left(\frac{T_0}{T_1} \right)}$$

$$V_2 = 0.8 V_0, T = ?$$

$$V_0 T_0^n = V_2 T_2^n$$

$$T_2 = 2.33 T_0$$

$$\frac{T_2 - T_0}{T_0} = 133\%$$

=

Q.13

$\alpha = 35^\circ$
 $V = 10$
 $D_0 = 32$
 $d = 0.125$
 $L_2 = 60$
 $f_T = 200$
 $f_c = 80$
 $\mu = ?$

$L_1 = \pi D_0$
 $= \pi \times 32$

$\gamma = \frac{L_2}{L_1} = \frac{60}{\pi \times 32} = 0.59$

$f_L >$

classical friction theorem:

$\mu = \frac{\tan(\gamma)}{\pi/2 \cdot \gamma} = 1.52$

$\phi = \tan^{-1} \left(\frac{\gamma \cos \alpha}{1 - \gamma \sin \alpha} \right)$
 $= 36.4^\circ$

(9) (a)

$d' = 28.7$

(5)

oblique machining

$z_1 = f \cos C_s = f \sin \lambda$
 $= 0.15 \times \sin 75^\circ$

$z_2 = 0.36$
 $= \frac{d'}{\sin \lambda}$

$K = \frac{z_2}{z_1} = \frac{0.36}{0.15} = 2.4$

$\gamma = \frac{1}{K} = 0.417$

$\theta = \tan^{-1} \left(\frac{\gamma \cos \alpha}{1 - \gamma \sin \alpha} \right)$

$\alpha = 10^\circ$

Q.15

$V_f = \gamma V_c$

$V_s = \frac{V_f \cos \alpha}{\sin \phi}$

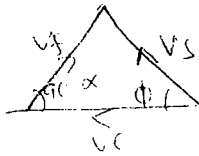

Q.19

Q.16

$O_f = 1.5$

$O_s = 6^\circ$

$\alpha_b = 10^\circ$

$D = 50$

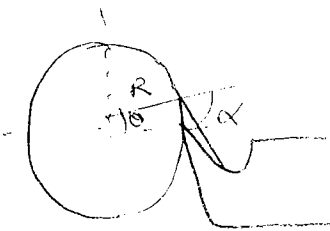

$\sin O_s = \frac{O_f}{R}$

$O_s = \sin^{-1} \left(\frac{1.5}{25} \right)$

$= \alpha_b + O_s'$

$\alpha = 10^\circ$

$z_1 = 0.125$

$f_c = 517$

$f_T = 217$

$z_2 = 0.43$

$[C_m] = 2\phi + \beta - \alpha$

$\gamma = \frac{f_1}{f_2} = 0.29$

$\phi = \tan^{-1} \left(\frac{\gamma \cos \alpha}{1 - \gamma \sin \alpha} \right)$

$\beta = \alpha + \tan^{-1} \left(\frac{f_T}{f_c} \right)$

Q.17

$C_{ve} = C_e - O_s$

at rubb $e.f = e.c \Rightarrow C_{ve} = e.c$

$\sin C_e = \frac{O_f}{R} \Rightarrow R = \frac{1.5}{\sin 40^\circ} = 2.36$

Q.20

let Q = No. of parts produced

$$(TC)_{EL} = \frac{30}{60} \times Q \times 80 = 40Q$$

$$(TC)_{TL} = 500 + \frac{6}{60} \times Q \times 160 = 500 + 16Q$$

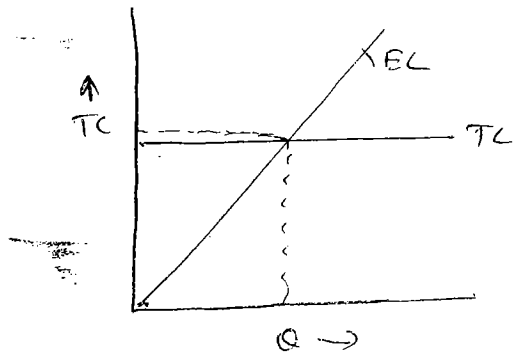

At BEQ,

$$(TC)_{EL} = (TC)_{TL}$$

$$40Q = 500 + 16Q$$

$$24Q = 500$$

$$Q = \frac{500}{24} \approx 21$$

$n > 21$ - turret is economical

$n < 21$ - engine lathe is economical

Q.21

$$n = 0.12, C = 130$$

$$C' = 1.1 \times 130 = 143$$

$$VT^D = C'$$

$$T = \left(\frac{C'}{V} \right)^{1/n}$$

$$= \left(\frac{143}{90} \right)^{1/0.12} \approx 47.4 \text{ min}$$

(a)

Q.22

$$VT^{0.2} = \frac{98 \cdot 30^{0.4}}{V_s^{0.5}}$$

$$(1) VT^{0.2} = \frac{98 \cdot 30^{0.4}}{V_s^{0.5}} \\ = \frac{98 \cdot 30^{0.4}}{0.4^{0.5}} \\ = 60.4$$

$$VT^{0.2} = 60.40$$

$$n = 0.2$$

$$C = 60.40$$

$$V_{opt} = C \left[\frac{n}{1-n} \cdot \frac{L_0}{C_0} \right]^D$$

$$= 60.4 \left[\frac{0.2}{1-0.2} \times \frac{60}{40} \right]^{0.2}$$

$$= 13.81$$

Q.23

$$P_z = S_0 t \left(\gamma \sec^2 \delta - \tan \delta + 1 \right)$$

$$S_0 = 0.12$$

$$t = 2.0$$

$$L_s = 400$$

$$\gamma = \frac{t_2}{t_1} = \frac{0.2}{0.12} = \frac{0.2}{0.12}$$

$$\gamma > 0$$

$$P_z =$$

$$\text{Power} = P = f_c \times V_c$$

$$= P_z \times \frac{V_f}{8}$$

$$= P_z \times \gamma V_f$$

$$=$$

$$\frac{V_f}{V_c} = 8$$

Q.24

$$V_1 = 50$$

$$T_1 = 4.5$$

$$V_2 = 10$$

$$T_2 = 2$$

$$V_{opt} = ?$$

$$V_1 T_1^n = V_2 T_2^n$$

$$\left(\frac{T_1}{T_2}\right)^n = \left(\frac{V_2}{V_1}\right)$$

$$n = \frac{\ln\left(\frac{V_2}{V_1}\right)}{\ln\left(\frac{T_1}{T_2}\right)}$$

$$= \frac{\ln\left(\frac{100}{50}\right)}{\ln\left(\frac{4.5}{2}\right)}$$

$$n \approx$$

$$C = V_1 T_1^n =$$

$$V_{opt} = C \left[\frac{n}{1-n} \cdot \frac{1}{T} \right]^n$$

Q.25

Tool life $\propto \frac{1}{\text{flank wear}}$

$$T \propto \frac{1}{\omega + \alpha}$$

$$T \propto \frac{1}{\tan \alpha}$$

$$\frac{T_2}{T_1} = \frac{\tan \alpha_1}{\tan \alpha_2} = \frac{\tan 7}{\tan 10}$$

$$= 0.7 T_1$$

Q.26

$$R_2 = \frac{f^2}{f_0}$$

$$f^2 = R_2 \times f_0$$

$$f = \sqrt{R_2 \times f_0}$$

=

Q.27

(a)

Q.28

$$V_1 = 50, T_1 = \frac{500}{10} = 50, \beta = 0.25, d = 1$$

$$V_2 = 80, T_2 = \frac{122}{10} = 12.2, \beta = 0.25, d = 1$$

$$V_1 T_1^n = V_2 T_2^n$$

$$\left(\frac{T_1}{T_2}\right)^n = \left(\frac{V_2}{V_1}\right)$$

$$n = \frac{\ln\left(\frac{80}{50}\right)}{\ln\left(\frac{50}{12.5}\right)}$$

$$V_1 T_1^n = V_3 T_3^n$$

$$V_3 = 60$$

$$T_3 = ?$$

$$\frac{2.9}{2.9} \text{ (a)}$$

Q.29

$$f_s = \frac{f_c}{\tan(\beta - \alpha)}$$

$$f_c =$$

$$f_s =$$

$$\phi = 30$$

$$\tan(\beta - \alpha) = \frac{f_T}{f_c}$$

$$(\beta - \alpha) = \tan^{-1}\left(\frac{f_T}{f_c}\right)$$

$$\text{(c) } 479.4 \text{ N}$$

Q.30

$$\frac{L}{f_0}$$

Q.31

$$\text{average slope} = \frac{60 - 10}{2 - 0.8} = \frac{50}{1.2}$$

$$\text{at } h = 1.8$$

$$= 10.8$$

$$T = 10 + \text{slope} \times (1.8 - 0.8)$$

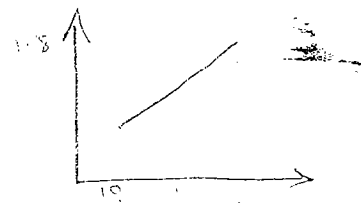

Q.32

$$z_1 = 0.24$$

$$z_2 = 0.48$$

$$\delta = \frac{z_1}{z_2}$$

$$\alpha = 0$$

$$\phi = \tan^{-1} \left(\frac{\delta \cos \alpha}{1 - \delta \sin \alpha} \right)$$

$$\approx 26.56 \quad \text{(b)}$$

Q.33

$$\frac{\text{work done}}{\text{MRR}}$$

$$W.D = \text{sp cutting energy} \times \text{MRR}$$

$$f_c \times v_c = 2 \times 10^3 \times v_f \times d$$

$$f_c = 2 \times 10^3 \times f_f \times d$$

=

Q.34

indirectly ask to calculate μ :

$$\tan(\beta - \alpha) = \frac{f_T}{f_c} = \frac{800}{1000}$$

$$\tan \beta = 0.8 = \mu$$

Q.35

$$D = 147$$

$$L = 630$$

$$v_1 = 90$$

$$v_2 = 120$$

$$T_1 = 24$$

$$T_2 = 12$$

$$f = 0.2$$

$$\alpha = 2$$

$$v_1 T_1^n = v_2 T_2^n$$

$$\left(\frac{T_1}{T_2} \right)^n = \frac{v_2}{v_1}$$

$$n = \frac{\ln \left(\frac{v_2}{v_1} \right)}{\ln \left(\frac{T_1}{T_2} \right)}$$

$$v_3 T_3^n = v_1 T_1^n$$

$$v_3 = ?$$

$$= 90.4$$

97

Q.36

$$V_3 = 97 = \frac{\pi D N}{1000}$$

$$N = \frac{1000 \times V_3}{\pi \times D}$$

$$\text{Time/act} = \frac{L}{f N}$$

$$= \frac{630}{0.24 N}$$

$$= 60$$

(c)

Q.37

$$\gamma = \frac{0.8}{1.5}$$

$$V_f = v_c \cdot \gamma$$

$$= \frac{0.8}{1.5} \times 1$$

=

Q.38

Q.39 (a)

Q.40, 41

40. (a)

41. (d)

Q.42

$$\beta = \tan^{-1} \mu$$

=

$$\alpha = \alpha = 18$$

$$2\phi + \beta - \alpha = 90$$

$$\phi =$$

Q.43

$$\angle = \angle u = \frac{f_s}{A_0} \times \sin \phi$$

$$f_s = \frac{460 \times 36 \times 0.25}{5 \sin \phi}$$

=

$$f_c = \frac{f_s}{\cos(\phi + (\beta - \alpha))} \cos(\beta - \alpha)$$

=

$$P = f_c \times V_c$$

Q.44

$$C = 100$$

$$n = 0.1$$

$$L_m = \frac{75}{60}$$

$$C_g = 5$$

$$T_{opt} = \left[\frac{1-n}{n} \frac{C_g}{L_m} \right]$$

Q.45

$$T = 180$$

$$V_a = \frac{100}{180^{0.2}} = 35$$

$$V_b = \frac{120}{180^{0.2}} = 37$$

$$V_a > V_b$$

fuel A best of the two spec (a)

Q.46

Q.46

$$V_{opt} = C \left[\frac{n}{1-n} \times \frac{1}{T_c} \right]^{0.2}$$

$$= 100 \left[\frac{0.2}{1-0.2} \times \frac{1}{15} \right]^{0.2}$$

=

Q.47

$$t_{max} = \frac{2 f_b}{N+1} \sqrt{\frac{d^3}{D}}$$

$$= \frac{2 \times 100}{500 \times 8} \sqrt{\frac{5}{100}}$$

$$= 0.011 \quad \text{(d)}$$

Q.48

Q.49

$$b = 2$$

$$z_i = 0.2$$

$$V_c = 60$$

$$\frac{f_c}{A_0} = 800$$

$$f_c = 800 \times A_0$$

$$= 800 \times 7 \times b$$

Q.50

$$= 320$$

$$P = f_c \times V_c = 320 \times \frac{60}{60} = 320$$

Q.51

$$C_{total} R_{z1} = \frac{f}{\tan 25 + 605} = 0.00$$

$$R_{z2} = \frac{f}{\tan 30 + 605} = 0.11$$

(b)

Q.52

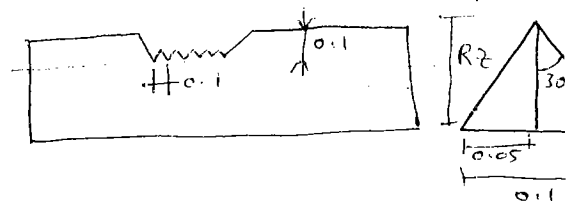

$$\tan 30 = \frac{0.05}{R_z}$$

$$R_z = \frac{0.05}{\tan 30} = 0.036$$

(c)

Q.53

- (a)
- rigidity ↑
- ductility ↑
- hardness ↓
- stroke ↑
- force ↓

Q.54

(a)

Q.55

0.625 (b)

Q.56

(a)

Q.57

(b)

Q.58

(d)

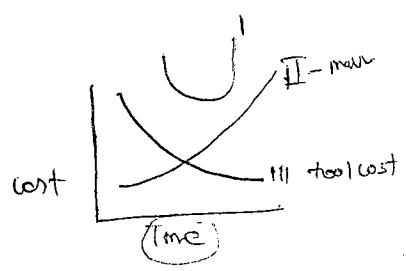

Q.59

$$V = \frac{\pi D N}{1000}$$

$$= \frac{\pi \times 100 \times 1000}{1000} = \underline{\underline{314 \text{ m/min}}}$$

SS cannot be used diamond costly

(a)

Q.60

$$\frac{f^2}{8\gamma}$$

z ⇒ 4 times

(b)

Q.61

uncut depth

$$r = \frac{r_1}{f_2} = \frac{0.1}{0.8}$$

$$\frac{1}{0.8} = \underline{\underline{1.66}}$$

(d)

Q.62

(b)

Q.63

$$T_m = \frac{L}{fN} = \frac{100}{0.04 \times \left(\frac{1000 \times 22}{\pi \times 0.5} \right)}$$

$$T = \left(\frac{25}{22} \right)^{\frac{1}{0.25}} =$$

for 425 cylinders

$$\frac{T_m \times 425}{T} = \underline{\underline{85}}$$

(d)

Q.64

(d) - 225

Q.65

1/3 (c)

$$V_1 T_1^2 = V_2 T_2^2$$

Q.66

Cubic boron nitride at least
min (a) (a)

Q.67

(c) 674

Q.68

(b) 270

Q.69

27.5 (d)

Q.70

350 (d)

Q.71

$$\phi = \tan^{-1} \left(\frac{\eta \cos \alpha}{1 - \eta \sin \alpha} \right)$$

$$SS = \frac{1}{\cos \phi} \tan(\phi - \alpha)$$

$$\approx 3.34$$

(d)

Q.72

(X - not required)

$$\beta - \alpha = \tan^{-1} \left(\frac{F_T}{F_C} \right)$$

$$2\phi + \beta - \alpha = 90$$

$$\phi = \frac{90 - (\beta - \alpha)}{2}$$

$$\phi = \underline{\underline{40.27}}$$

shear stress

$$\tau = \cot \phi + \tan(\phi - \alpha)$$

$$\alpha = ?$$

$$\mu = \frac{z_1}{z_2} = \frac{\sin \phi}{\sin(\phi - \alpha)}$$

$$\cos(\phi - \alpha) = \frac{\sin \phi}{\mu}$$

$$\phi - \alpha =$$

$$SS = \cot \phi + \tan(\phi - \alpha)$$

Q.73

$$\beta - \alpha = \tan^{-1} \left(\frac{F_T}{F_C} \right) \Rightarrow \beta =$$

$$\mu = \tan \beta =$$

Q.74 Energy lost in friction = $f \times V_f$

Q.75

$$v_1 T_1^n = v_2 T_2^n$$

$$n = 0.5$$

$$k = 540 \quad \text{(c)}$$

Q.76

200%

Q.77

$$\text{At BEP} \Rightarrow V_a = V_b = V$$

$$T_a = T_b = T$$

$$T_a = \left(\frac{90}{V} \right)^{1/0.45} = \left(\frac{60}{V} \right)^{1/0.5}$$

$$V = \underline{\underline{26.7}}$$

Q.78 (a)

Q.79 (a)

Q.80 (d)

Q.81

A true

R - false

(c)

Q.82

AV

R X

(c)

Q.83

(a)

AV

RV

✓

Q.84

(d)

Q.85

(B)

Q.86

(A)

(A)

1,2,3,4

- 1,2,4,3 also

Q.87

(d)

384

Q.88

(B)

P77

Conduction

Q.1 B

Q.2 B

Q.3

Q.4

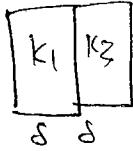

$$R_{eq} = R_1 + R_2$$

$$\frac{2d}{kA} = \frac{d}{k_1 A} + \frac{d}{k_2 A}$$

$$\frac{k_2}{2} = \frac{k_1 k_2}{k_1 + k_2}$$

$$k_2 = 2 \frac{k_1 k_2}{k_1 + k_2}$$

(d)

Q.5 B

Q.6 (B) and (D)

Q.7 (C)

Q.8 C

Q.9 B

Q.10 C

Q.11 A

Q.12 A

Q.13 B

Q.14 B

Q.15

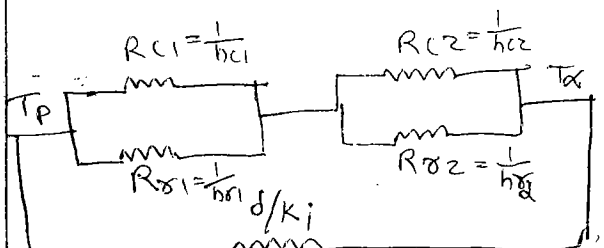
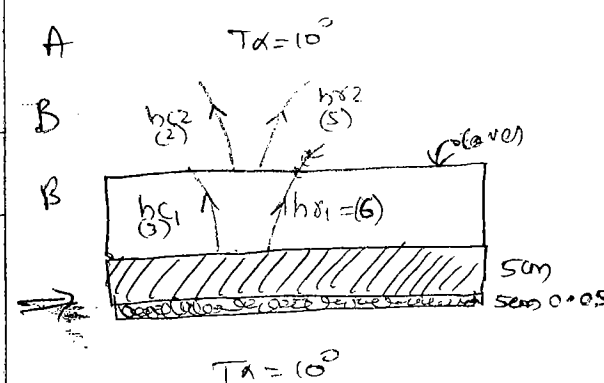

$$Q = \frac{70-10}{R_{eq}}$$

$$= 50.5 \text{ @ (A)}$$

Q.14

Q = H.T from bare pipe

$$= h A \Delta T$$

$$= h \pi d_2 L \Delta T$$

$d_2 = 2.5$

Q' = H.T with insulation

$$= 0.207 \times Q$$

$$= \frac{\Delta T}{\frac{\ln(\frac{r_2}{r_1})}{2\pi k_i L} + \frac{1}{h_o 2\pi r_o L}}$$

0.207 =

$$0.207 \times h_o 2\pi r_o L \Delta T = \frac{\Delta T}{\frac{\ln(\frac{r_2}{r_1})}{2\pi k_i L} + \frac{1}{h_o 2\pi r_o L}}$$

$$\left. \begin{matrix} h_o = 10 \\ d_2 = 2.5 \\ r_2 = 12.5 \end{matrix} \right\} r_o = \underline{\hspace{2cm}}$$

$$r_o = r_2 + \delta$$

Q.16 (C) 1680

Q.17 (a) (d) (c)

(b) (d)

Q.18 C

Q.19 B

- Q.20 C
- Q.21 A
- Q.22 A
- Q.23 A
- Q.24 B

- Q.27 A
- Q.28 C
- Q.29 C
- Q.30 B
- Q.31 C
- Q.32 A
- Q.33 C
- Q.34 D
- Q.35 D
- Q.36 D
- Q.37 B
- Q.38 A
- Q.39 D
- Q.40 D

Q.25 $Q = \frac{G \times \omega^3}{10 \times 60}$

$A = A_c = 10 \text{ cm}^2$
 $= 10 \times 10^{-4} \text{ m}^2$

$l = g = 1 \text{ m}$

$Q = \frac{\Delta T}{\left(\frac{d}{kA}\right)}$

$\Delta T = Q \times \frac{d}{kA}$

Q.25 (d) d.5

Q.26 0.407

inside wall temp \geq dew point temp.

Q.27

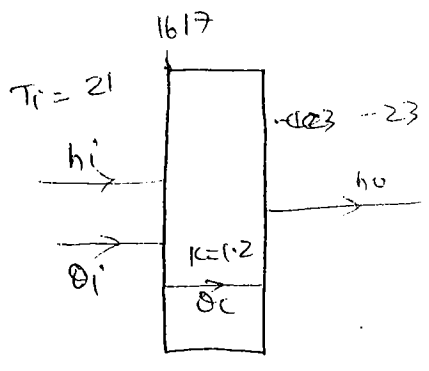

$\theta_i = \theta_c$

$\frac{(21 - 10.17)}{\frac{1}{h_i \times A}} = \frac{\Delta T}{\left(\frac{d}{kA}\right)}$

$h_i(21 - 10.17) = (1.2 \times 1.2) \frac{d}{d} - (-23) \frac{d}{d}$

$d =$

90

FINIS

- Q.1 C
- Q.2 D
- Q.3 B
- Q.4 D
- Q.5 D
- Q.6 B
- Q.7 A
- Q.8 C
- Q.9 C
- Q.10 A
- Q.11 B
- Q.12 A
- Q.13 B

- Q.22 D
- Q.23 C AV RX
- Q.24 Condensates
- Q.25 A

Machining

Page 21

Q.19 - Q.25
Q.20

Q.21 -
(I)
(II)

(B)

Q.22 (B)

23 (B)

Q.24 B

Q.25 A

Q.26 B

Q.27 C

Q.28

Q.29 D

Q.30 D

Q.31 C

Q.32 B

Q.33 D

Q.34 D

Q.35 D

Q.36 A

Q.37 C

Q.38 D

39 - B

40 - C

41 - B

42 - D

43 - (A)

44 - A

45 - C

~~46~~

~~47~~

97

Heat Exchanger

- Q.11 B
- Q.12 B 8%
- Q.13 C
- Q.14 C 1.22
- Q.15 D
- Q.16 A
- Q.17 B
- Q.18 B
- Q.19 A
- Q.20 C
- Q.21 C

maximo
846

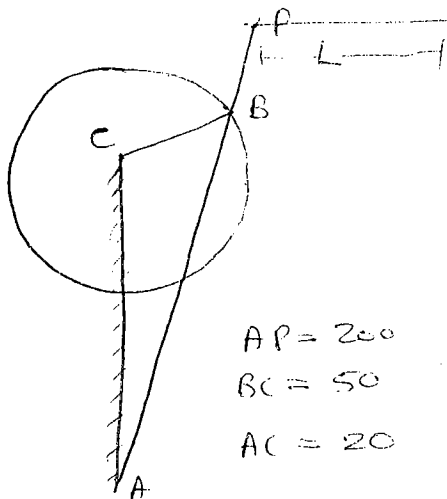

$$AP = 200$$

$$BC = 50$$

$$AC = 20$$

$$L = 2 AP \left(\frac{BC}{AC} \right)$$

An 1m/ani

(47) D

48 (A) ~~A~~ ~~R~~ ~~X~~ (C) AV BX

(49) AX BX

(50) (C) AV BX

(51) Arithmetic progression

(52)

(53) B

(54)

7-1pm - 1M ER

2-4pm - DF

4:30-6 Num net

6-8 - Calcul

ansreddy567@yahoo.co.in

175/✓

Handwritten text, possibly bleed-through from the reverse side of the page.

Vertical handwritten text along the right edge of the page, possibly a list or index.